



Series PD

Quick Start Guide



Ethernet-Enabled Temperature/Process Controller



1241 Bundy Boulevard., Winona, Minnesota USA 55987
Phone: +1 (507) 454-5300, Fax: +1 (507) 452-4507 <http://www.watlow.com>



Safety Information

We use note, caution and warning symbols throughout this book to draw your attention to important operational and safety information.

A “NOTE” marks a short message to alert you to an important detail.

A “CAUTION” safety alert appears with information that is important for protecting your equipment and performance. Be especially careful to read and follow all cautions that apply to your application.

A “WARNING” safety alert appears with information that is important for protecting you, others and equipment from damage. Pay very close attention to all warnings that apply to your application.

The safety alert symbol,  (an exclamation point in a triangle) precedes a general CAUTION or WARNING statement.

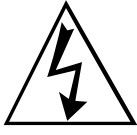
The electrical hazard symbol,  (a lightning bolt in a triangle) precedes an electric shock hazard CAUTION or WARNING safety statement.



**CAUTION or
WARNING**

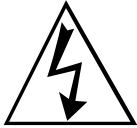

**Electrical
Shock Hazard**

CAUTION or WARNING

Technical Assistance

If you encounter a problem with your Watlow controller, review your configuration information to verify that your selections are consistent with your application: inputs, outputs, alarms, limits, etc. If the problem persists, you can get technical assistance from your local Watlow representative (see back cover), by e-mailing your questions to wintechsupport@watlow.com or by dialing +1 (507) 494-5656 between 7 a.m. and 5 p.m., Central Standard Time (CST). Ask for an Applications Engineer. Please have the following information available when calling:

- Complete model number
- All Series PD configuration information
- Quick Start Guide or User’s Manual
- Computer Hardware / Software Configuration

Warranty

The Series PD is manufactured by ISO 9001-registered processes and is backed by a three-year warranty.

Return Material Authorization (RMA)

1. Call Watlow Customer Service, (507) 454-5300, for a Return Material Authorization (RMA) number before returning any item for repair. We need this information:

- Ship to address
- Contact name
- Method of return shipment
- Detailed description of the problem
- Name and phone number of person returning the product.
- Bill to address
- Phone number
- Your P.O. number
- Any special instructions

2. Prior approval and an RMA number, from the Customer Service Department, is needed when returning any unused product for credit. Make sure the RMA number is on the outside of the carton, and on all paperwork returned. Ship on a Freight Prepaid basis.

3. After we receive your return, we will examine the unit and try to verify the reason for the return.

4. In cases of manufacturing defect, we will enter a repair order, replacement order or issue credit for material returned.

5. To return products that are not defective, goods must be in new condition, in the original boxes and they must be returned within 120 days of receipt. A 20 percent restocking charge is applied for all returned stock controls and accessories.

6. If the unit is unrepairable, it will be returned to you with a letter of explanation.

7. Watlow reserves the right to charge for no trouble found (NTF) returns.

Chapter 1 - Overview2
Chapter 2 - Install and Wire3
Dimensions3
Mounting the Series PD4
Removing the Series PD4
Series PD Connector Locations5
Wiring the Series PD6
Power6
Thermocouple Input 1 & 27
RTD Input 17
RTD Input 28
Process Input 1 & 28
Dual Digital Inputs9
Dual Current Transformer (CT) Inputs10
One Digital and One CT Input11
Output 113
Output 214
Output 316
Output 417
Chapter 3 - Indicator Lights19
Chapter 4 - Ethernet Communications20
Getting Started20
Network Services21
Chapter 5 - Troubleshooting22
Appendix24
Specifications24
Ordering Information26
Declaration of ConformityInside back cover

1

Overview

The Series PD controller is a DIN rail mounted, general purpose industrial PID temperature/process controller. The Series PD is available in single and dual channel versions and features an embedded web server to provide an easy to use interface for configuration and monitoring of processes. The controller also features several popular communications protocols to facilitate easy integration into most existing process management systems.

The Series PD accepts thermocouple, RTD and process signal control inputs and also features optional auxiliary digital or current transformer (CT) inputs. Up to four control or event (alarm) outputs can be selected on either the single or dual channel versions.

Advanced features of the Series PD controllers include internal data logging of key control parameters, smart sensor technology, heater burn out detection and an enhanced control algorithm.

The SERIES PD controller is backed by a three-year warranty from Watlow Winona and is UL[®] 508, C-UL[®], CSA and CE approved.

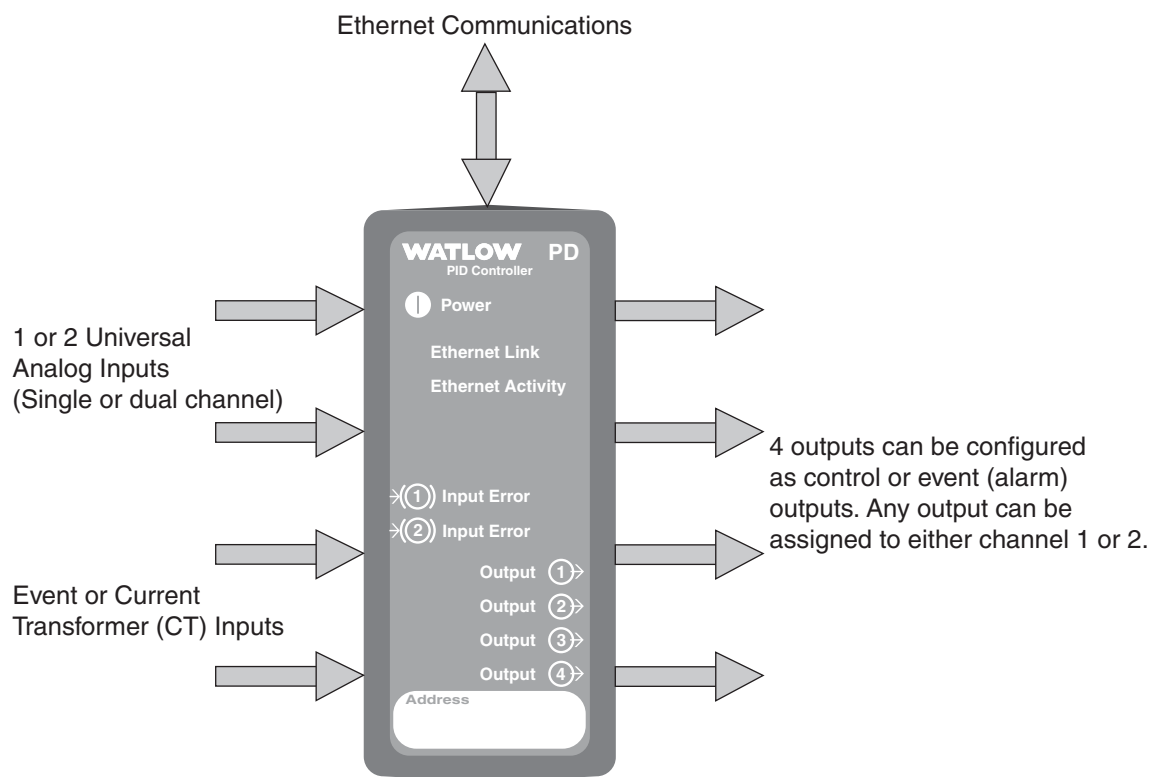

Figure 2 — Series PD inputs and outputs.

2

Install and Wire

Series PD Dimensions

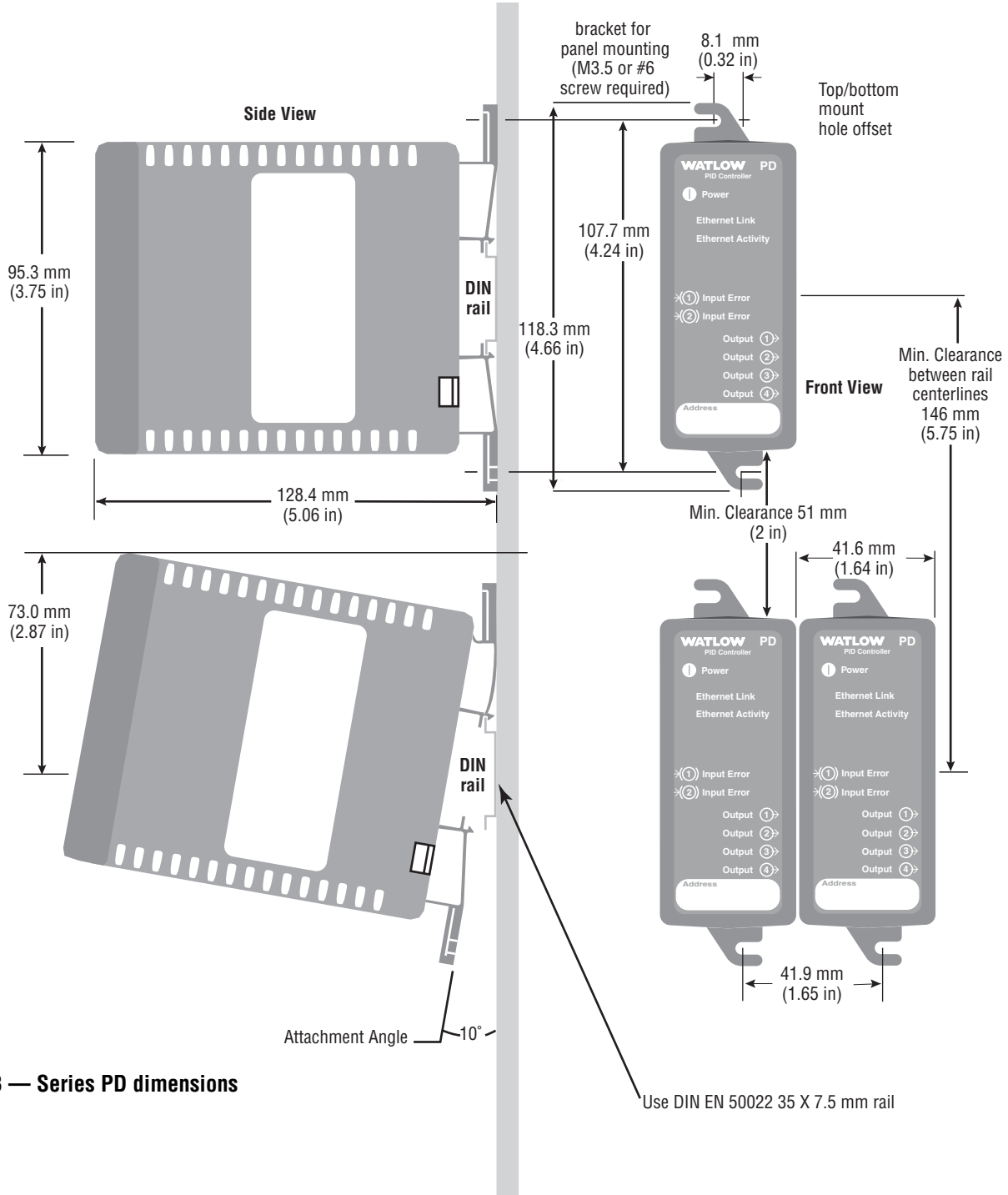

Figure 3 — Series PD dimensions



Caution: Maintain the correct spacing between rows of controllers to allow sufficient air circulation and installation clearance. Failure to do so could result in damage to equipment.

Mounting the Series PD



Figure 4a — Mounting

1. Push unit in and down to catch rail hook on top of rail.
2. Rotate bottom of unit toward rail.
3. Rail clasp will audibly “snap” into place. If the Series PD does not snap into place, check to see if the rail is bent.

Removing the Series PD



Figure 4b — Removal

1. Press down on back of the Series PD until the bottom hook clears the rail.
2. Rotate bottom up and away from rail.

Series PD Connector Locations

Two connectors on the bottom of the unit provide connection points for the input power, inputs and outputs. These connectors are removable and each terminal position is numbered.

The RJ-45 connector is located on the top of the Series PD to allow connection to an Ethernet network.

Input and Output Connectors

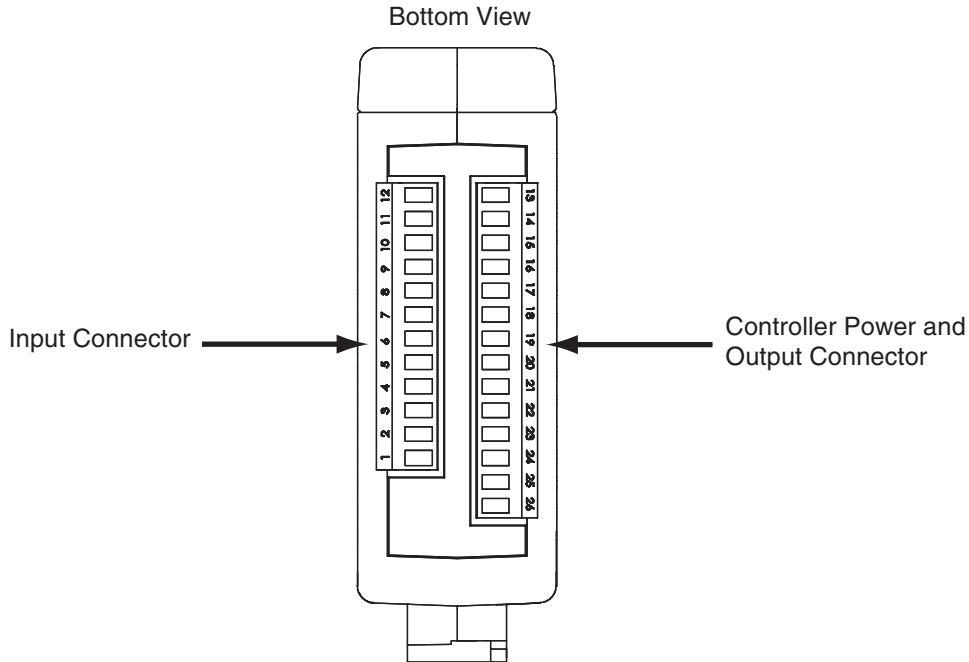

Figure 5a — Input and Output Connectors

Ethernet RJ-45 Connector

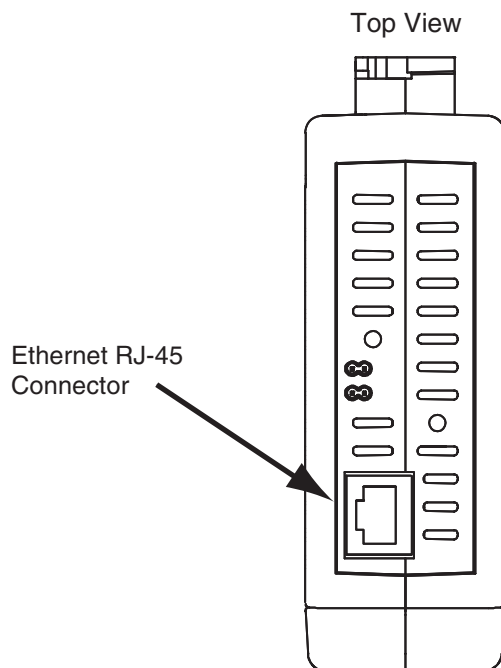

Figure 5b — RJ-45 Connector



Warning:

Use National Electric (NEC) or other country-specific standard wiring and safety practices when wiring and connecting this controller to a power source and to electrical sensors or peripheral devices. Failure to do so may result in damage to equipment and property, and/or injury or loss of life.

Wiring the Series PD

Isolation Blocks

There are no electrical connections between these blocks

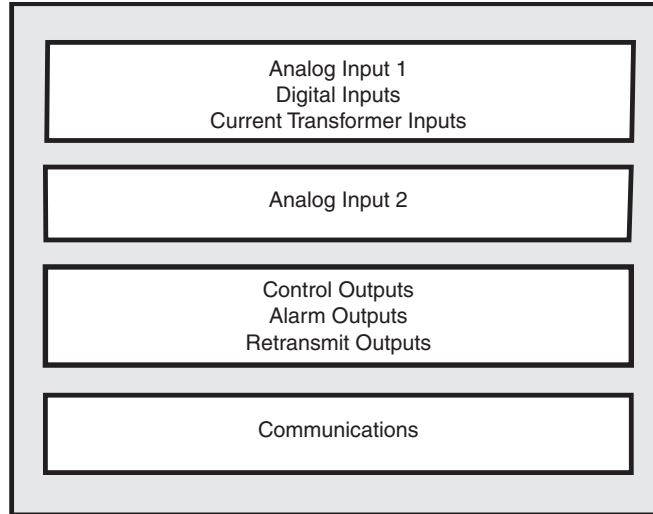

Relay outputs (mechanical and solid-state) provide isolation through their relay contacts. Each relay output is isolated from the blocks above and is isolated from other relay outputs.

The model number for each output option appears with its wiring diagram. Check the label on the controller and compare your model number to those shown here and to the model number breakdown in the Appendix of this manual.

All outputs are referenced to a de-energized state.

All wiring and fusing must conform to the National Electric Code and to any locally applicable codes as well.



WARNING: If high voltage is applied to the controller, irreversible damage will occur.

Figure 6a — Power Wiring

(all model numbers)

- Nominal voltage: 24V \approx (ac/dc)

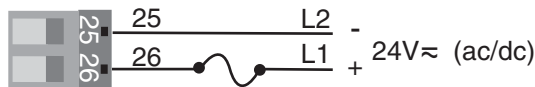



Warning:
 Use National Electric (NEC) or other country-specific standard wiring and safety practices when wiring and connecting this controller to a power source and to electrical sensors or peripheral devices. Failure to do so may result in damage to equipment and property, and/or injury or loss of life.

Figure 7a — Thermocouple Input 1

(all model numbers)

Thermocouples are polarity sensitive. The negative lead (usually red) must be connected to terminal 9.

- Input impedance: >20 MΩ

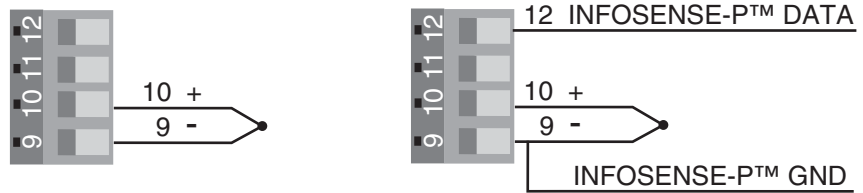

Figure 7b — Thermocouple Input 2

PDD _- - - - -

Thermocouples are polarity sensitive. The negative lead (usually red) must be connected to terminal 5.

- Input impedance: >20 MΩ
- Input 2 isolated from Input 1

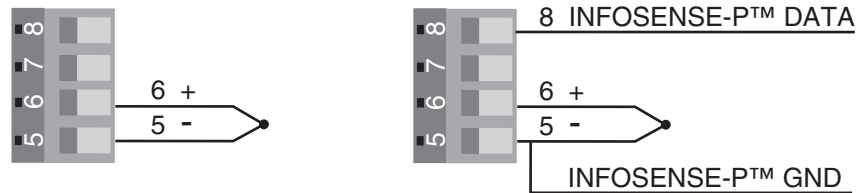

Figure 7c — 2-Wire RTD Input 1 (100 Ω DIN curve 0.00385 Ω/Ω/°C)

(all model numbers)

Terminals 9 and 11 must be shorted for a two-wire RTD.

- Nominal excitation current: 250 μA

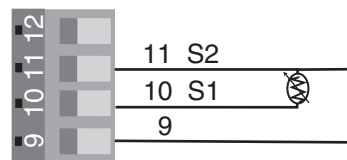
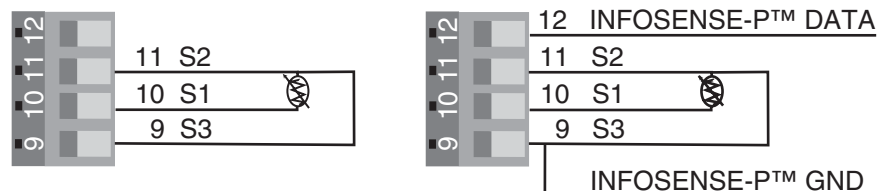

Figure 7d — 3-Wire RTD Input 1 (100 Ω DIN curve 0.00385 Ω/Ω/°C)

(all model numbers)

The S1 lead (usually white) must be connected to terminal 10.

- Nominal excitation current: 250 μA





Warning:

Use National Electric (NEC) or other country-specific standard wiring and safety practices when wiring and connecting this controller to a power source and to electrical sensors or peripheral devices. Failure to do so may result in damage to equipment and property, and/or injury or loss of life.

Figure 8a — **2-Wire RTD Input 2 (100 Ω DIN curve 0.00385 Ω/Ω/°C)**

PDD - - - - -

Terminals 5 and 7 must be shorted for a two-wire RTD.

- Nominal excitation current: 250 μA

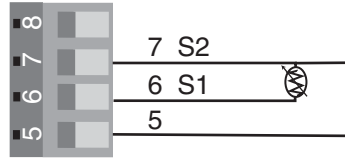
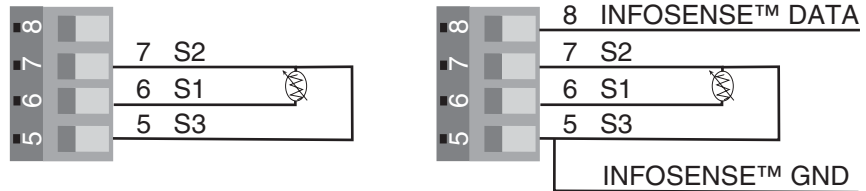

Figure 8b — **3-Wire RTD Input 2 (100 Ω DIN curve 0.00385 Ω/Ω/°C)**

PDD - - - - -

The S1 lead (usually white) must be connected to terminal 6.

- Nominal excitation current: 250 μA



WARNING: Process input may not have sensor break protection. Outputs can remain full on.

Figure 8c — **Input 1, 0 to 10V_{DC} (dc) Process Input**

(all model numbers)

- Input impedance 20 kΩ, dc only

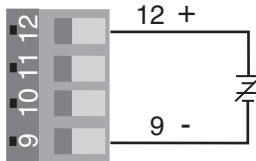
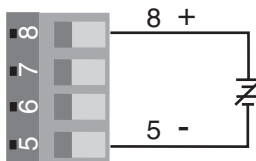

Figure 8d — **Input 2, 0 to 10V_{DC} (dc) Process Input**

PDD - - - - -

- Input impedance 20 kΩ, dc only
- Input 2 isolated from Input 1





Warning:

Use National Electric (NEC) or other country-specific standard wiring and safety practices when wiring and connecting this controller to a power source and to electrical sensors or peripheral devices. Failure to do so may result in damage to equipment and property, and/or injury or loss of life.



WARNING: Process input may not have sensor break protection. Outputs can remain full on.

Figure 9a — Input 1, 0 to 20 mA Process Input

(all model numbers)

- Input impedance 100 Ω, dc only
- Controller does not supply power for the current loop

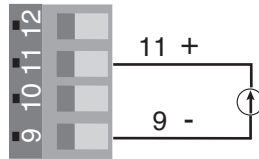
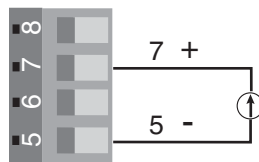

Figure 9b — Input 2, 0 to 20 mA Process Input

PDD _ - - - - -

- Input impedance 100 Ω, dc only
- Controller does not supply power for the current loop
- Input 2 isolated from Input 1



Dual Digital Inputs

PD_ 1- - - - -

- Input impedance 10kΩ, dc only
- Input 2 isolated from Input 1

Figure 9c — Voltage input

0-1V_{DC} (dc) Event Input Low State

2-36V_{DC} (dc) Event Input High State

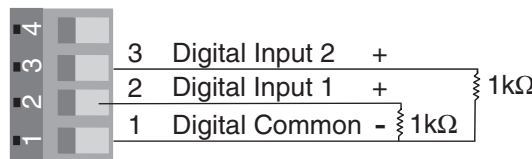

Add a 1kΩ pull down resistor for each active input

Note: Install a 1kΩ pull-down resistor for each digital input using voltage inputs.

Figure 9d — Contact closure

0-2kΩ Event Input Low State

> 7kΩ Event Input High State

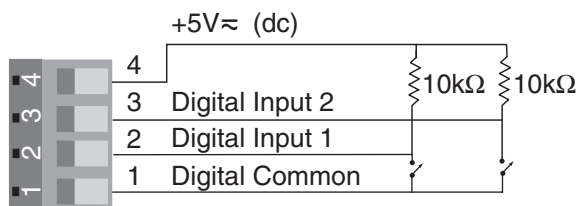

Add a 10kΩ pull up resistor for each active input

Note: Install a 10kΩ pull-up resistor for each digital input using contact closure inputs.



Warning:

Use National Electric (NEC) or other country-specific standard wiring and safety practices when wiring and connecting this controller to a power source and to electrical sensors or peripheral devices. Failure to do so may result in damage to equipment and property, and/or injury or loss of life.

Note: Current transformer (CT) must be purchased separately.

Note: A current transformer input cannot be associated with a process output on Output 1 or 3.

Figure 10a — Digital input internal circuit

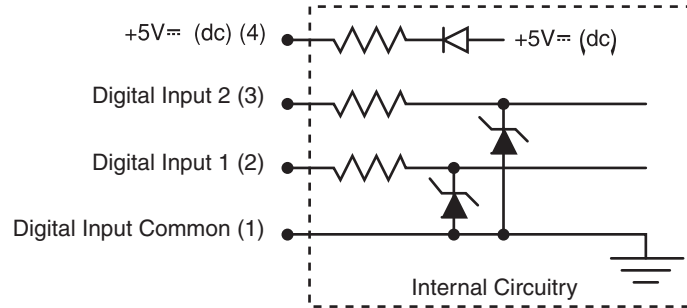

Dual Current Transformer (CT) Inputs

PD_ 3- - - - -

- Input impedance 100Ω, Vac only.

The current transformer (CT) must be purchased separately. Watlow CT part number is 16-0246 (up to 50 amps).

Systems that are more than 50 amps need an interstage transformer. For example, if you use a 300 amp CT, part number 16-0073, and an interstage transformer, part number 16-0176, the 300 amp CT provides a 5 amp signal to the interstage transformer. In turn, the interstage transformer provides a 20 mA maximum signal to the controller.

Figure 10b — Single Phase

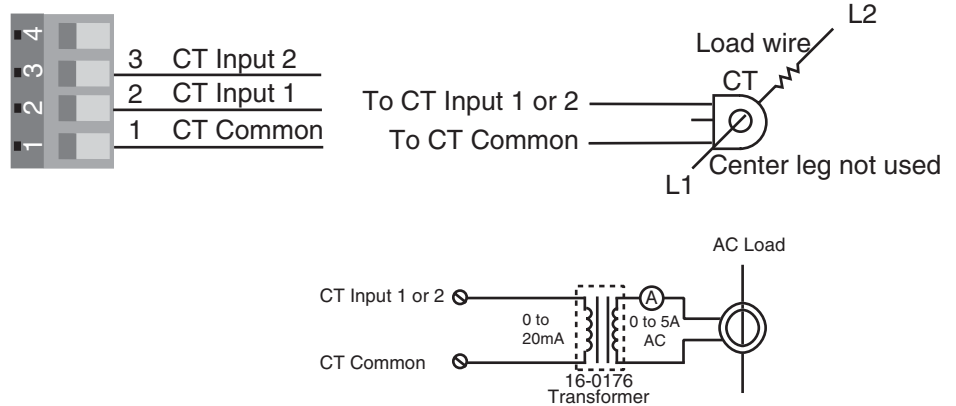

Single phase current sensing up to 300 amp



Warning:

Use National Electric (NEC) or other country-specific standard wiring and safety practices when wiring and connecting this controller to a power source and to electrical sensors or peripheral devices. Failure to do so may result in damage to equipment and property, and/or injury or loss of life.

Note: Current transformer (CT) must be purchased separately.

Note: A current transformer input cannot be associated with a process output on Output 1 or 3.

Figure 11a — Three Phase using Two Current Transformers

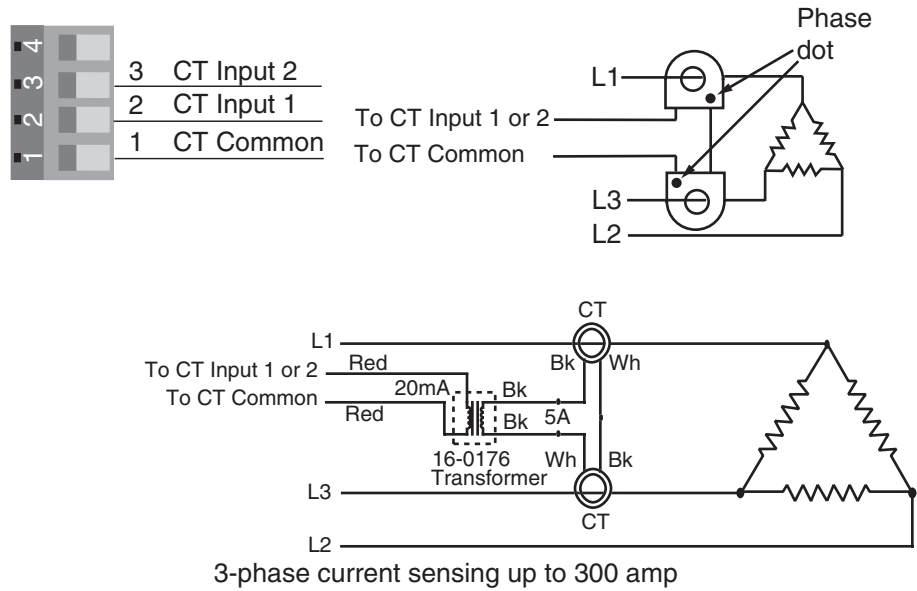

One Digital Input and One Current Transformer Input

PD_ 2-_-_-_-_-

Digital Input 1

- Input impedance 10kΩ, dc only

Figure 11b — Voltage input

- 0-1V \approx (dc) Event Input Low State
- 2-36V \approx (dc) Event Input High State

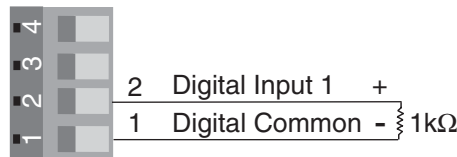

Add a 1kΩ pull down resistor for each active input

Figure 11c — Contact closure

- 0-2kΩ Event Input Low State
- > 7kΩ Event Input High State

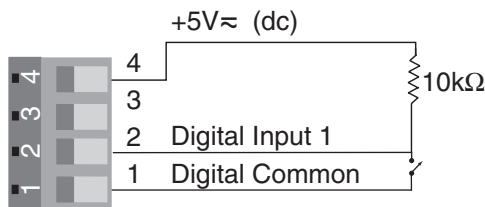

Contact Closure (add a 10kΩ pull up resistor for each active input)

Note: Install a 1kΩ pull-down resistor for each digital input using voltage inputs.

Note: Install a 10kΩ pull-up resistor for each digital input using contact closure inputs.



Warning:

Use National Electric (NEC) or other country-specific standard wiring and safety practices when wiring and connecting this controller to a power source and to electrical sensors or peripheral devices. Failure to do so may result in damage to equipment and property, and/or injury or loss of life.

Note: Current transformer (CT) must be purchased separately.

Note: A process output cannot be installed on Output 1 or 3 when using current transformer input.

Figure 12a — **Current Transformer Input 2, Single Phase**

- Input impedance 100Ω, Vac only

The current transformer must be purchased separately. Watlow current transformer part number is 16-0246 (up to 50 amps).

Systems that are more than 50 amps need an interstage transformer. For example, if you use a 300 amp current transformer, part number 16-0073, and an interstage transformer, part number 16-0176, the 300 amp current transformer provides a 5 amp signal to the interstage transformer. In turn, the interstage transformer provides a 20 mA maximum signal to the controller.

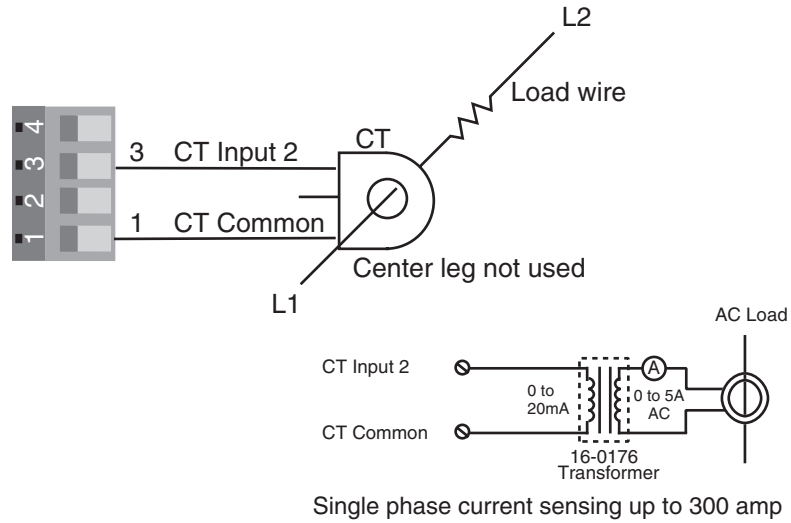
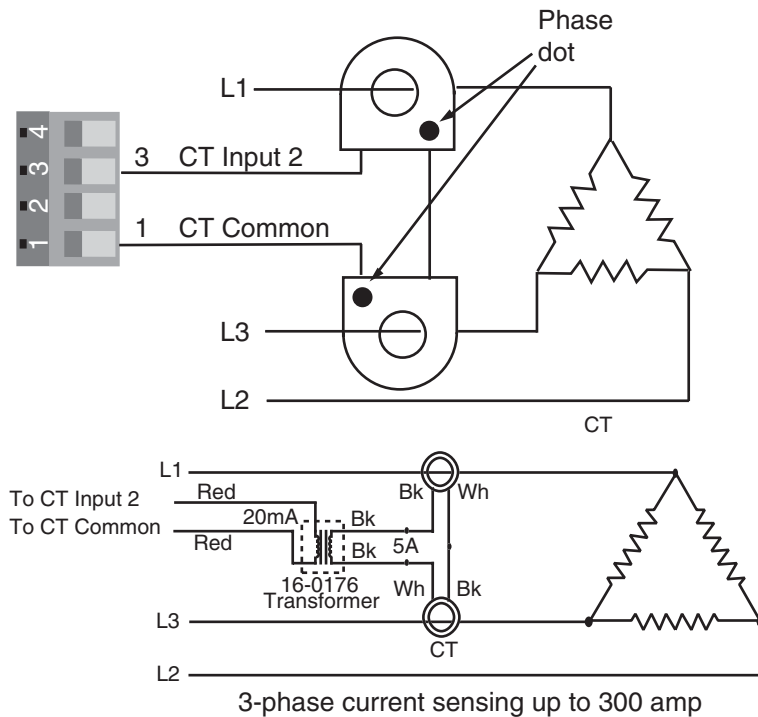

Figure 12b — **Current Transformer Input 2, Three Phase**





Warning:

Use National Electric (NEC) or other country-specific standard wiring and safety practices when wiring and connecting this controller to a power source and to electrical sensors or peripheral devices. Failure to do so may result in damage to equipment and property, and/or injury or loss of life.

Quencharc Note:

Switching pilot duty loads (relay coils, solenoids, etc.) with the mechanical relay or solid-state relay output options requires use of an R.C. suppressor.

Watlow carries the R.C. suppressor Quencharc brand name, which is a trademark of ITW Paktron. Watlow Part No. 0804-0147-0000.

Figure 13a — Output 1 Mechanical Relay

PD__ - J _____

- Form A contact
- 2 A, resistive
- 125 VA pilot duty, 120/240V~ (ac), inductive
- 240V~ (ac) maximum
- 30V= (dc) maximum
- See Quencharc note
- For use with ac or dc
- Minimum load current 10 mA
- Output does not supply power

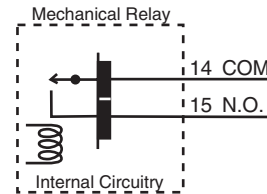
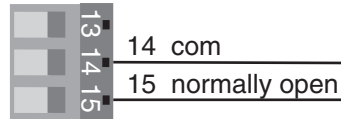

Figure 13b — Output 1 Solid-state Relay

PD__ - K _____

- Form A contact
- 0.5 A, resistive
- 20 VA pilot duty, 120/240V~ (ac), inductive
- 24 to 240V~ (ac)
- See Quencharc note
- Minimum load current 10 mA
- Maximum leakage current 100 µA
- Not for use with direct current (dc)
- Output does not supply power

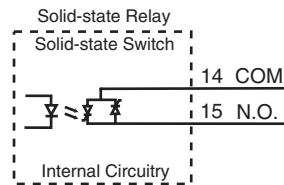
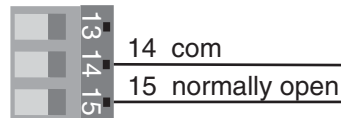
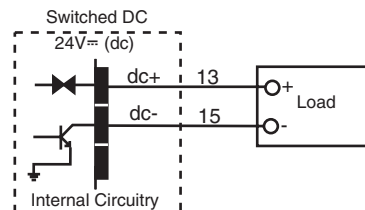

Figure 13c — Output 1 Switched DC

PD__ - C _____

- Supply current 30 mA= (dc) maximum
- Supply voltage 24V= (dc)
- Not recommended for switching mechanical relays
- Output supplies power





Warning:

Use National Electric (NEC) or other country-specific standard wiring and safety practices when wiring and connecting this controller to a power source and to electrical sensors or peripheral devices. Failure to do so may result in damage to equipment and property, and/or injury or loss of life.

Quencharc Note:

Switching pilot duty loads (relay coils, solenoids, etc.) with the mechanical relay or solid-state relay output options requires use of an R.C. suppressor.

Watlow carries the R.C. suppressor Quencharc brand name, which is a trademark of ITW Paktron. Watlow Part No. 0804-0147-0000.

Note: A current transformer input is not available if Output 1 or 3 is a process output.

Figure 14a — Output 1 Open Collector

PD__ - C_____

- Maximum current sink 250 mA \approx (dc)
- Maximum supply voltage 42V \approx (dc)
- Output does not supply power

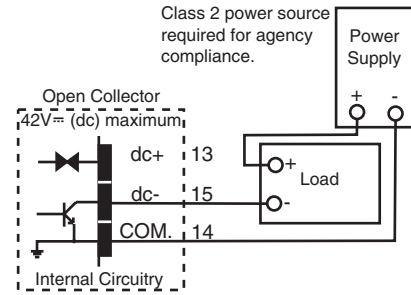

Figure 14b — Output 1 Process

PD__ - F_____

- Analog output is scalable between 0 to 10V \approx (dc) or 0 to 20 mA \approx (dc)
- Load capability: voltage 1 k Ω minimum; current 800 Ω maximum
- Output supplies power
- Cannot use voltage and current output at the same time

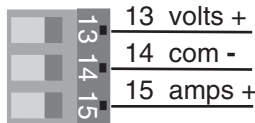
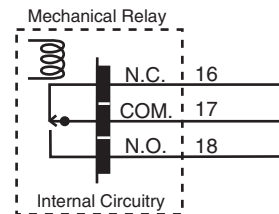
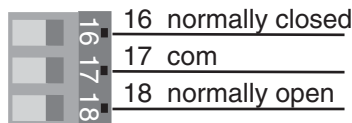

Figure 14c — Output 2 Mechanical Relay

PD__ - E_____

- Form C contacts
- 2 A, resistive
- 125 VA pilot duty, 120/240V \sim (ac), inductive
- 240V \sim (ac) maximum
- 30V \approx (dc) maximum
- See Quencharc note
- For use with ac or dc
- Minimum load current: 10 mA
- Output does not supply power





Warning:

Use National Electric (NEC) or other country-specific standard wiring and safety practices when wiring and connecting this controller to a power source and to electrical sensors or peripheral devices. Failure to do so may result in damage to equipment and property, and/or injury or loss of life.

Quencharc Note:

Switching pilot duty loads (relay coils, solenoids, etc.) with the mechanical relay or solid-state relay output options requires use of an R.C. suppressor.

Watlow carries the R.C. suppressor Quencharc brand name, which is a trademark of ITW Paktron. Watlow Part No. 0804-0147-0000.

Figure 15a — Output 2 Solid-state Relay

PD _ _ - - **K** _ _ - _ _ _ _

- Form A contact
- 0.5 A, resistive
- 20 VA pilot duty, 120/240V~ (ac), inductive
- 24 to 240V~ (ac)
- See Quencharc note
- Minimum load current 10mA
- Maximum leakage current 100µA
- Not for use with direct current (dc)
- Output does not supply power

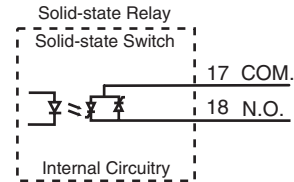
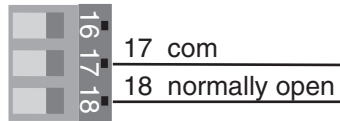

Figure 15b — Output 2 Switched DC

PD _ _ - - **C** _ _ - _ _ _ _

- Maximum supply current 30 mA \approx (dc)
- Supply voltage 24V \approx (dc)
- Not recommended for switching mechanical relays
- Output supplies power

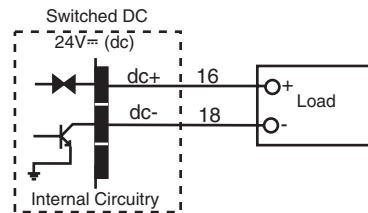
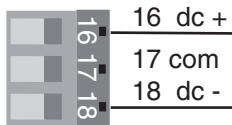
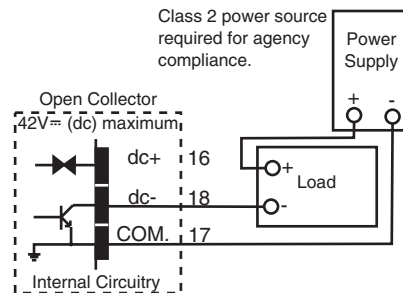
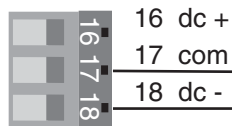

Figure 15c — Output 2 Open Collector

PD _ _ - - **C** _ _ - _ _ _ _

- Maximum current sink 250 mA \approx (dc)
- Maximum supply voltage 42V \approx (dc)
- Output does not supply power





Warning:

Use National Electric (NEC) or other country-specific standard wiring and safety practices when wiring and connecting this controller to a power source and to electrical sensors or peripheral devices. Failure to do so may result in damage to equipment and property, and/or injury or loss of life.

Quencharc Note:

Switching pilot duty loads (relay coils, solenoids, etc.) with the mechanical relay or solid-state relay output options requires use of an R.C. suppressor.

Watlow carries the R.C. suppressor Quencharc brand name, which is a trademark of ITW Paktron. Watlow Part No. 0804-0147-0000.

Figure 16a — Output 3 Mechanical Relay

PD_ _ - _ _ J _ - _ _ _ _

- Form A contact
- 2 A, resistive
- 125 VA pilot duty, 120/240V~ (ac), inductive
- 240V~ (ac) maximum
- 30V= (dc) maximum
- See Quencharc note
- For use with ac or dc
- Minimum load current: 10 mA
- Output does not supply power

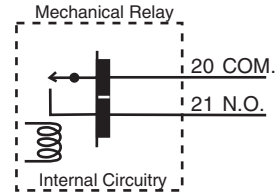
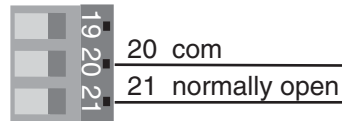

Figure 16b — Output 3 Solid-state Relay

PD_ _ - _ _ K _ - _ _ _ _

- Form A contact
- 0.5 A, resistive
- 20 VA pilot duty, 120/240V~ (ac), inductive
- 24 to 240V~ (ac)
- See Quencharc note
- Minimum load current 10 mA
- Maximum leakage current 100 μA
- Not for use with direct current (dc)
- Output does not supply power

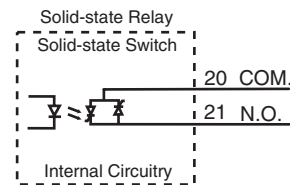
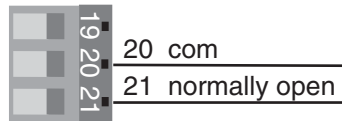
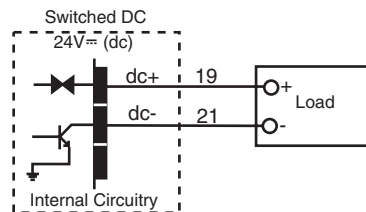
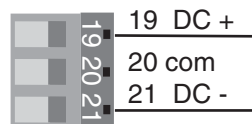

Figure 16c — Output 3 Switched DC

PD_ _ - _ _ C _ - _ _ _ _

- Maximum supply current 30 mA= (dc)
- Supply voltage 24V= (dc)
- Not for switching mechanical relays
- Output supplies power





Warning:

Use National Electric (NEC) or other country-specific standard wiring and safety practices when wiring and connecting this controller to a power source and to electrical sensors or peripheral devices. Failure to do so may result in damage to equipment and property, and/or injury or loss of life.

Quencharc Note:

Switching pilot duty loads (relay coils, solenoids, etc.) with the mechanical relay or solid-state relay output options requires use of an R.C. suppressor.

Watlow carries the R.C. suppressor Quencharc brand name, which is a trademark of ITW Paktron. Watlow Part No. 0804-0147-0000.

Note: A current transformer input is not available if Output 1 or 3 is a process output.

Figure 17a — Output 3 Open Collector

PD_ _ - _ _ C - - - - -

- Maximum current sink 250 mA \approx (dc)
- Maximum supply voltage 42V \approx (dc)
- Output does not supply power

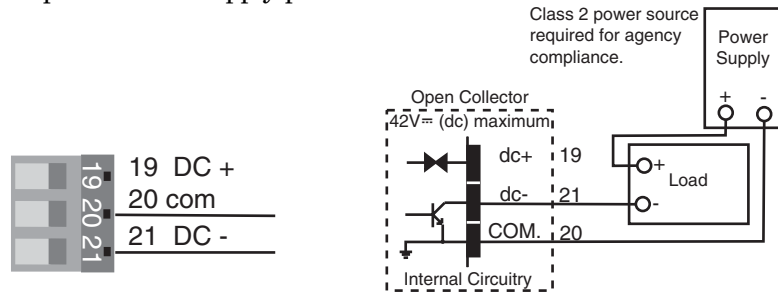

Figure 17b — Output 3 Process

PD_ _ - _ _ F - - - - -

- Analog output scalable from 0 to 10V \approx (dc) or 0 to 20 mA \approx (dc)
- Load capability: voltage, 1 k Ω minimum; current, 800 Ω maximum
- Output supplies power
- Cannot use voltage and current output at the same time

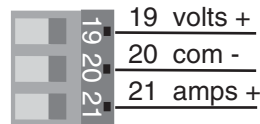
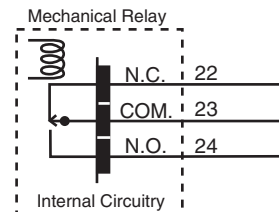
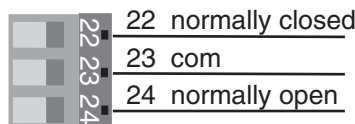

Figure 17c — Output 4 Mechanical Relay

PD_ _ - _ _ E - - - - -

- Form C contacts
- 2 A, resistive
- 125 VA pilot duty, 120/240V \sim (ac), inductive
- 240V \sim (ac) maximum
- 30V \approx (dc) maximum.
- See Quencharc note
- For use with ac or dc
- Minimum load current: 10 mA
- Output does not supply power





Warning:

Use National Electric (NEC) or other country-specific standard wiring and safety practices when wiring and connecting this controller to a power source and to electrical sensors or peripheral devices. Failure to do so may result in damage to equipment and property, and/or injury or loss of life.

Quencharc Note:

Switching pilot duty loads (relay coils, solenoids, etc.) with the mechanical relay or solid-state relay output options requires use of an R.C. suppressor.

Watlow carries the R.C. suppressor Quencharc brand name, which is a trademark of ITW Paktron. Watlow Part No. 0804-0147-0000.

Figure 18a — Output 4 Solid-state Relay

PD__ - - - - K - - - - -

- Form A.contact
- 0.5 A, resistive
- 20 VA pilot duty, 120/240V~ (ac), inductive
- 24 to 240V~ (ac)
- See Quencharc note
- Minimum load current 10mA
- Maximum leakage current 100µA
- Not for use with direct current (dc)
- Output does not supply power

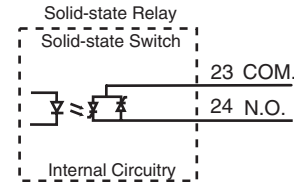
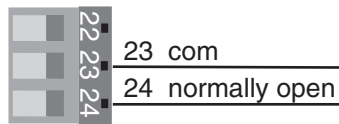

Figure 18b — Output 4 Switched DC

PD__ - - - - C - - - - -

- Maximum supply current 30 mA \approx (dc)
- Supply voltage 24V \approx (dc)
- Not recommended for switching mechanical relays
- Output supplies power

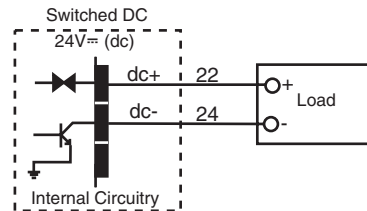
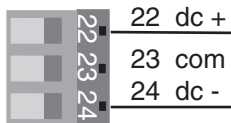
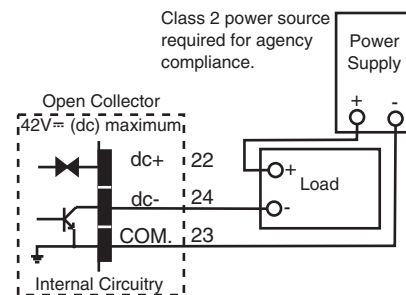
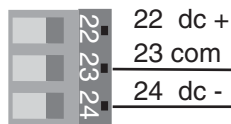

Figure 18c — Output 4 Open Collector

PD__ - - - - C - - - - -

- Maximum current sink 250 mA \approx (dc)
- Maximum supply voltage 42V \approx (dc)
- Output does not supply power



3

Indicator Lights

The Series PD controller may have up to nine LED indicator lights to help you monitor the status of input power, Ethernet functions, input errors and outputs status. These LEDs can provide a quick visual indication of basic controller functions.

Power

Green light stays lit when the power is on.

- If not lit or flashing, check your power source.

Ethernet Link:

Green light is lit if the Ethernet cable is correctly wired and connected to a 10BaseT port.

- If not lit, check for the correct RJ-45 cable and switch/hub speed.

Ethernet Activity

Green light is lit when communication activity occurs.

(1) Input Error

Red light is lit if there is a sensor problem on Input 1. Lights momentarily after power up.

- If it stays lit:
 - Verify the sensor wiring, polarity and function.
 - Rewire or replace as necessary.

(2) Input Error

Red light is lit if there is a sensor problem on Input 2. Lights momentarily after power up.

- If it stays lit:
 - Verify the sensor wiring, polarity and function.
 - Rewire or replace as necessary.

(1) Output

Red light is lit or flashes when control Output 1 is active. If it does not light up, the output is not active. The output may be configured as an event (alarm) or control.

(2) Output

Red light is lit or flashes when control Output 2 is active. If it does not light up, the output is not active. The output may be configured as an event (alarm) or control.

(3) Output

Red light is lit or flashes when control Output 3 is active. If it does not light up, the output is not active. The output may be configured as an event (alarm) or control.

(4) Output

Red light is lit or flashes when control Output 4 is active. If it does not light up, the output is not active. The output may be configured as an event (alarm) or control.

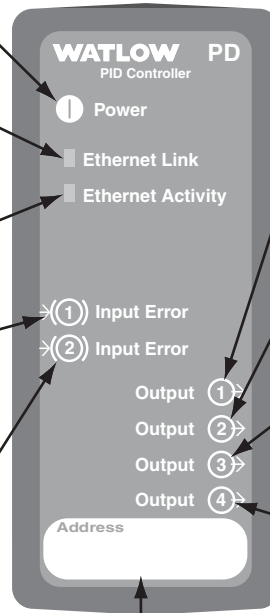

Address Field

Record the unit's Device Name in erasable marker here. For example, PD012345.

Figure 18 — Series PD LED Indicator Lights

4

Ethernet Communications

Network security is a critical issue for any network. Be sure to work with your network administrator to ensure that you follow best security practices to ensure a secure network environment. Here are some items to consider when installing Ethernet based controls on any network.

- Use private IP addresses.
- Separate the process network(s) from business network(s).
- If external access is required, then have a single point of access to the process network.
- External access points should be protected by a firewall.
- External access points should be protected by a layer 3 switch.
- Access to the Internet should be indirect, going through an access point to the business network on the way.
- Separate processes or cells using VLANs.
- Run virus protection software on all PC's on the process network.

Using an HTTP Browser such as Microsoft Internet Explorer 4.0 or Netscape Navigator 4.0 or higher, you may access the Series PD and view controller parameters via an onboard Web (HTTP) server.

The Series PD supports full product configuration and monitoring of runtime parameters via MODBUS TCP over TCP/IP using a third party software package such as Lookout™, created and sold by National Instruments.

The 10BaseT Ethernet connection supports the TCP/IP stack. At the application layer it has an HTTP (web) and Modbus server. The HTTP server provides a means of changing runtime parameters via HTML. The TCP/IP stack supports DHCP client, AutoIP, static IP, DNS client, and Netbios name resolution. The 10BaseT connector is an RJ45 per the IEEE 802.3 specification.

Getting Started

1. Connect the Series PD to your computer's Ethernet port using a cross-wired RJ45 cable or connect the Series PD to a switch/hub or network using a straight wired RJ45 Category 5 cable. The Series PD is limited to a 10BaseT connection and will not work on an Ethernet port set for 100BaseT only. Use of a 10/100 switch/hub will overcome this issue if your PC has only a 100BaseT port.
2. Wire a 24V \approx (ac/dc) power supply to the Series PD power terminals. See wiring section.
3. Wire sensor inputs and controller outputs. See wiring section.
4. Power up the controller, switch/hub and PC.
5. Start your Internet browser. Enter the Browse at address of the Series PD into the browser's address field. See figure on next page for the Browse at address location on the left side label. Two different Netbios names may be used to access the Series PD. Either PDxxxxxx, where xxxxxx is the first six digits of the serial number, located on the left side label, or WATxxxxxx, where xxxxxx is the last six digits of the Series PD MAC address. The MAC address is also printed on the left side label of the Series PD in the form xx:xx:xx:xx. See figure on next page.

Note: If you are not using a DHCP server, it may take several minutes for both the Series PD and your computer to get their IP addresses.

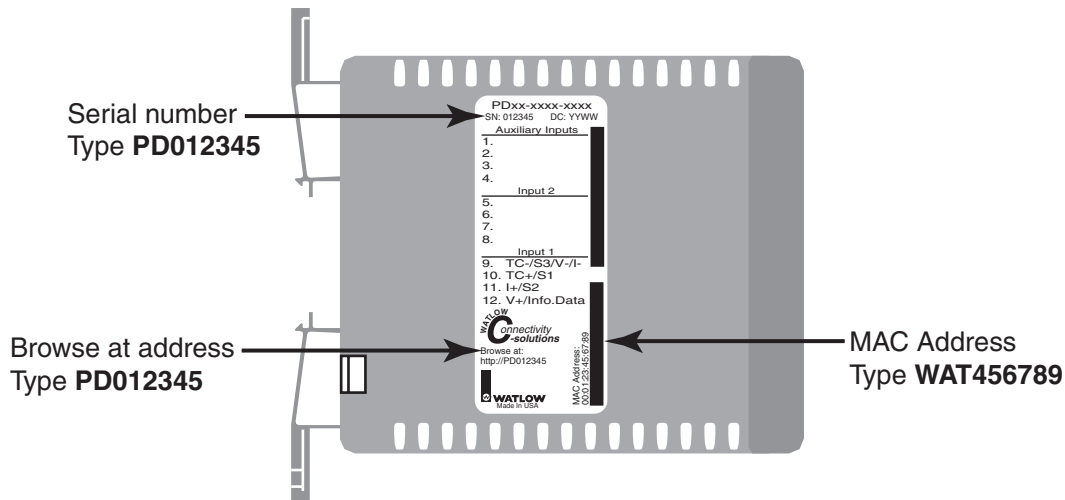

Figure 21 — Browse at address, MAC address, and Serial number locations

6. When you select any page other than Monitor Page, you are prompted to enter a Network Security user name and password. The defaults are:
 - user name - **new**
 - password - **user**
7. Once you enter the user name and password you can access the other controller pages. If you browse another address or close your browser, you will be required to enter this information again.
8. To change security level passwords, go to the Configuration Page and click on Security.
9. To configure the Series PD, go to the Configuration Page.

Note: The controller leaves the factory with all inputs, outputs and control loops set to off.

Go through each Configuration Page screen and make the appropriate selections for your application. Click the Submit button at the bottom of each page.

Note: Be sure to click the Submit button at the bottom of any Configuration Page screen to send your changes to the controller. Changes are not entered into the controller until you submit them.

9. Select the Monitor Page. Your process values and set points will be displayed. You can change controller set point and the mode of operation, auto or manual. Select the parameter value you want to change by double clicking or highlighting it, enter the new parameter value and press the Enter key. This will send the Series PD the new value and refresh the Monitor Page screen.

⚠ Caution: Information on the Monitor Page, including alarms and errors, is not automatically refreshed. You must click the refresh link on the Monitor page to request the latest controller information. The Monitor Page is re-freshed anytime you change set point or auto/manual mode.

Network Services

The Series PD supports DHCP client, autoIP, and static IP for address assignment. Normally you will not need to make any changes. The user is able to configure preferences as to which services are used if available. Intelligence is employed within the gateway to revert to backup IP assignment methods if the primary method is unavailable.

When using autoIP, the Series PD starts with the IP address 169.254.10.10. If this address is already in use, it will randomly attempt other addresses in the 169.254.XX.XX subnet. As with any IP networking device, the IP address assigned to the Series PD must be compatible with the network it is physically connected to.

Note: If you are using autoIP, it may take several minutes for both the Series PD and your computer to get their IP addresses.

The Series PD does support DNS client and Netbios name resolution. Configuration information may be entered at the Network Display Setup page.

5

Troubleshooting

Indication	Probable Cause(s)	Corrective Action
<p>Power LED not lit. Controller appears dead. No communications to PC.</p>	<ul style="list-style-type: none"> • Power supply switch off. • Fuse blown. • Breaker tripped. • Safety interlock door switch activated. • Separate system limit control latched. • Wiring incorrect or open. • Power supply voltage incorrect. • Defective controller. 	<ul style="list-style-type: none"> • Turn switch on. • Replace fuse (check cause of failure). • Reset breaker (check cause of failure). • Close door. • Reset limit controller. • Check wiring. • Verify input power • Repair or replace controller.
<p>Ethernet Link LED not lit. No communications to PC.</p>	<ul style="list-style-type: none"> • Incorrect cable. • Defective PC or switch/hub. • Defective controller. 	<ul style="list-style-type: none"> • Replace cable - use straight cable for switch/hub, cross cable for direct connection to PC. • Replace Ethernet port on PC or switch/hub. • Repair or replace controller.
<p>Ethernet Link Activity LED not lit. No communication to PC.</p>	<ul style="list-style-type: none"> • Incorrect IP address assignment. • Incorrect PC set-up. • Defective controller. 	<ul style="list-style-type: none"> • Assign same logical address. Fixed IP address may have been assigned. • Ensure Microsoft Client and Netbios is loaded. • Repair or replace controller.
<p>Input Error LED lit. Sensor over range, under range message on PC.</p>	<ul style="list-style-type: none"> • Open sensor. • Shorted sensor. • Process has exceeded operating range. • Incorrect sensor configuration. • Defective controller. 	<ul style="list-style-type: none"> • Replace sensor. • Repair wiring or replace sensor. • Operate controller within sensor operation range. • Configure Analog Input to correct sensor type. • Repair or replace controller.
<p>Ambient error message on PC.</p>	<ul style="list-style-type: none"> • Temperature is less than 0°C (32°F) or greater than 65°C (149°F). • Controller calibration is incorrect or corrupt. • Defective controller. 	<ul style="list-style-type: none"> • Regulate temperature in cabinet. • Recalibrate controller. • Repair or replace controller.
<p>No Output from controller. Output always active. Output always inactive.</p>	<ul style="list-style-type: none"> • Incorrect wiring. • DC voltage used with AC output. • External voltage is not supplied for appropriate outputs. • Wrong output choice. • Incorrect configuration. • Power limit is in effect or in open loop mode. • Defective controller. 	<ul style="list-style-type: none"> • Correct wiring, see wiring section. • K output is for AC control, C & F output is for DC control. • Wire correct voltage to be controlled for appropriate output, see wiring section. • Replace controller with correct outputs. • Configure Control Loop, PID, and Output. • Adjust power limit or change to closed loop mode. • Repair or replace controller.

Indication	Probable Cause(s)	Corrective Action
Alarm will not activate or clear.	<ul style="list-style-type: none"> • Controller is in Error condition. • Alarm is in latched setting. • Alarm is silenced. • Incorrect configuration. • Incorrect wiring. • Wrong output type. • Defective controller. 	<ul style="list-style-type: none"> • Determine cause of error and correct. • Wait for process to return to normal and acknowledge alarm. • Wait for process to return to normal and alarm will work correctly. • Configure Alarm, Alarm Set Point, Hysteresis, Silencing and Latching. • Correct wiring. • Replace controller with correct output type. • Repair or replace controller.
Controller's process value reading is decreasing as the actual process is increasing.	<ul style="list-style-type: none"> • Thermocouple is reversed wired. • Analog voltage or current input scaling is reversed. 	<ul style="list-style-type: none"> • Check thermocouple wire for correct polarity. • Configure correct scaling on Input page.
Controller does not control close enough to set point.	<ul style="list-style-type: none"> • PID values incorrect. • Cycle times incorrect. • Heat or cooling capacity incorrectly sized for application. • Incorrect sensor placement. • Controller is in Manual mode (open loop). • Control loop action configured incorrect. 	<ul style="list-style-type: none"> • Tune controller (Auto Tune or Manual Tune). • Set cycle time to match hardware on Control Loop . • Size energy sources to match load. • Place sensor in optimal location. • Change to Auto mode (closed loop) on Monitor page. • Configure Control Loop Action on Control Loop page.
Output cycles (turns on and off) too frequently.	<ul style="list-style-type: none"> • Wrong control mode. PID control selected instead of ON-OFF control. • The cycle time is set too short. 	<ul style="list-style-type: none"> • Activate ON-OFF control on Output page. • Increase Output Cycle Time on Output page.
Cannot access Security, Monitor, Configuration or Calibration page.	<ul style="list-style-type: none"> • Password is enabled and incorrect password is supplied. 	<ul style="list-style-type: none"> • Provide the correct user name and password.
Process value reads incorrectly	<ul style="list-style-type: none"> • Analog input is configured incorrectly. • Thermocouple sensor shorted. • Process sensor scaled incorrectly. • Calibration offset is incorrect. • Sensor is wired incorrectly. • Controller calibration is incorrect or corrupt. • Defective controller. 	<ul style="list-style-type: none"> • Configure control for appropriate sensor input on Analog Input page. • Repair wiring or replace sensor. • Set scaling on Analog Input page. • Correctly set calibration offset. • Wire sensor per wiring section. • Recalibrate controller. • Repair or replace controller.

6

Appendix

Specifications

(2341)

Controller

- Microprocessor based user-selectable control modes
- Single or dual channel universal inputs
- Current transformer inputs to monitor heater currents
- Digital inputs
- Up to four programmable outputs
- Update rates, inputs = 10Hz, outputs = 10Hz

Operator Interface

- Browser based HMI (human machine interface)

Standard Conditions For Specifications

- Ambient temperature 25°C (77°F) ±3°C, rated line voltage, 50 to 60Hz, 0 to 90% RH non-condensing, 15-minute warm-up

Universal Analog Input

- Sample rate: 10 Hz

Thermocouple

- Type J, K, T, N, E, C, (W5), D (W3), PTII (F), R, S, B thermocouple types.
- >20 MΩ input impedance
- Maximum 20 Ω source resistance

RTD

- 2- or 3-wire platinum, 100 Ω
- DIN curve (.00385 curve)
- 250 μA nominal RTD excitation current

Process

- Range selectable: 0 to 10V_{rms} (dc), 0 to 20 mA. (Can reverse low and high values.)
- Voltage input impedance 20 kΩ
- Current input impedance 100 Ω
- Minimum current source resistance 1 MΩ
- Input resolution 25,000 bits (approximately) at full scale

Input Accuracy Span Ranges

Type J:	0 to 750°C or 32 to 1,382°F
Type K:	-200 to 1,250°C or -328 to 2,282°F
Type T:	-200 to 350°C or -328 to 662°F
Type N:	0 to 1,250°C or 32 to 2,282°F
Type E:	-200 to 800°C or -328 to 1,470°F
Type C (W5):	0 to 2,315°C or 32 to 4,200°F
Type D (W3):	0 to 2,315°C or 32 to 4,200°F
Type PTII (F):	0 to 1,393°C or 32 to 2,540°F
Type R:	0 to 1,450°C or 32 to 2,642°F
Type S:	0 to 1,450°C or 32 to 2,642°F
Type B:	870 to 1,700°C or 1,598 to 3,092°F
RTD (DIN):	-200 to 800°C or -328 to 1,472°F
Process:	-1,999 to 9,999 un

Thermocouple Input

- Calibration accuracy and sensor conformity: ±0.1% of input span ±1°C at standard conditions
- Temperature stability: ±0.2 degree per degree change in ambient for J, K, T, N, E, PTII ±0.5% for C, D, R and S

RTD Input

- Calibration accuracy ±0.1% of input range ±1°C at standard conditions
- Temperature stability: ±0.05 degree per degree change in ambient

Process Input

- Voltage input ranges
Accuracy ±10mV ±1 LSD at standard conditions
Temperature stability ±100 ppm/°C maximum
- Milliamp input ranges
Accuracy ±20μA ±1 LSD at standard conditions
Temperature stability ±100 ppm/°C maximum

Digital Input

- Contact closure or voltage input
- Input impedance:10 kΩ
- Sample rate: 5 Hz
- Resistance/contact input
Input high state >7 kΩ
Input low state 0-2 kΩ
- Voltage input
Input high state 2-36 Vdc_{rms}
Input low state 0-1 Vdc_{rms}

Current Transformer Input

- Input range: 0-50 mA_{rms} (ac)
- Input impedance:100Ω
- Sample rate: 5 Hz

Allowable Operating Ranges

Type J:	-210 to 1,200°C or -346 to 2,192°F
Type K:	-270 to 1,372°C or -454 to 2,502°F
Type T:	-270 to 400°C or -454 to 752°F
Type N:	-270 to 1,300°C or -454 to 2,372°F
Type E:	-270 to 1000°C or -454 to 1,832°F
Type C:	0 to 2,315°C or 32 to 4,200°F
Type D:	0 to 2,315°C or 32 to 4,200°F
Type PTII (F):	-3 to 1,396°C or 25 to 2,545°F
Type R:	-50 to 1,767°C or -58 to 3,214°F
Type S:	-50 to 1,767°C or -58 to 3,214°F
Type B:	0 to 1,820°C or 32 to 3,308°F
DIN	-200 to 800°C or -328 to 1,472°F
Process	-1,999 to 9,999 un

Output Types

Open Collector

- Maximum voltage: 42V_{DC} (dc)
- Maximum current: 500 mA
- Class 2 power source required

Switched DC

- Supply voltage : 24V_{DC} (dc) @ 30 mA
- Supply voltage maximum: 28V_{DC} (dc) into an infinite load

Solid-state Relay

- Optically isolated
- Zero cross switched
- Without contact suppression
- Minimum load current: 500 μ A rms
- 0.5A at 24 to 240V_{AC} (ac), resistive
- 20 VA pilot duty, 120/240V_{AC} (ac), inductive
- Maximum offstate leakage current: 10 μ A rms
- Use RC suppression for inductive loads

Electromechanical Relay, Form A

- Minimum load current: 10 mA
- 2 A @ 240V_{AC} (ac) or 30V_{DC} (dc), resistive
- 125 VA pilot duty, 120/240V_{AC} (ac), inductive
- Electrical life 100,000 cycles at rated current
- Use RC suppression for inductive loads

Electromechanical Relay, Form C

- Minimum load current: 10 mA
- 2 A @ 240V_{AC} (ac) or 30V_{DC} (dc), resistive
- 125 VA pilot duty, 120/240V_{AC} (ac), inductive
- Electrical life 100,000 cycles at rated current
- Use RC suppression for inductive loads

Process (Control or Retransmit)

- Range selectable: 0 to 20 mA, 4 to 20 mA, 0 to 5V_{DC} (dc), 1 to 5V_{DC} (dc), 0 to 10V_{DC} (dc) (Can reverse low and high values.)
- Reverse or direct acting
- 0 to 10V_{DC} (dc) voltage output into 1,000 Ω minimum load resistance
- 0 to 20 mA current output into 800 Ω maximum load resistance
- Resolution:
 - dc ranges: 2.5 mV nominal
 - mA ranges: 5 μ A nominal
- Calibration accuracy:
 - dc ranges: \pm 15 mV
 - mA ranges: \pm 30 μ A
- Temperature stability: 100 ppm/ $^{\circ}$ C

Communications

Ethernet

- Isolated
- Ethernet RJ 45 connector, 10 base T
- HTTP interface
- DHCP, auto IP or fixed IP addressing

Agency Approvals

- UL[®]508 File #102269, C-UL[®], CSA and CE
UL[®] is a registered trademark of the Underwriter's Laboratories, Inc.
- Submitted to Canadian Standards Association for testing.

Terminals

- Touch-safe
- Compression: Will accept 0.2 to 4 mm² (22 to 12 AWG) wire
- Wire strip length: 6 mm (0.24 in)
- Torque terminal blocks to 0.9. Nm (8 in-lb)

Power

- 24V_{AC} (ac/dc) +10%; -15%; 50/60 Hz, \pm 5%
- Class 2 power source required.
- 14VA maximum power consumption
- Data retention upon power failure via nonvolatile memory

Operating Environment

- 0 to 65 $^{\circ}$ C (32 to 149 $^{\circ}$ F)
- 0 to 90% RH, non-condensing
- Storage temperature: -40 to 85 $^{\circ}$ C (-40 to 185 $^{\circ}$ F)

Dimensions

- Width x height x depth
42 mm x 118 mm x 128 mm (1.64 in x 4.66 in x 5.06 in)
- DIN rail or chassis mount
DIN rail spec DIN 50022, 35 mm x 7.5 mm (1.38 in x 0.30 in)

Note: These specifications are subject to change without prior notice.

Ordering Information (2342)

	P	D							A
Control Type	S or D								
S	Single channel								
D	Dual channel								
Auxiliary Inputs	A, 1, 2 or 3								
A	None								
1	Dual digital inputs								
2	One CT input and one digital input								
3	Dual CT inputs (dual channel only)								
Output 1	C, K, F or J								
C	Switched dc, open collector								
K	SSR, Form A, 0.5 A								
F	Universal process								
J	Mechanical relay, Form A, 2 A								
Output 2	A, C, K or E								
A	None								
C	Switched dc, open collector								
K	SSR, Form A, 0.5 A								
E	Mechanical relay, Form C, 2 A								
Output 3	A, C, K, F* or J								
A	None								
C	Switched dc, open collector								
K	SSR, Form A, 0.5 A								
F	Universal process*								
J	Mechanical relay, Form A, 2 A								
Output 4	A, C, K or E								
A	None								
C	Switched dc, open collector								
K	SSR, Form A, 0.5 A								
E	Mechanical relay, Form C, 2 A								
Data Logging	0 or 1								
0	None								
1	16 megabytes of on-board memory								
Custom options	AA or BB								
AA	Watlow logo								
BB	No logo								

* Note: Available only if "F" output option is selected for Output 1.

Accessories

120~(ac) input, 24= (dc) output, Class 2 power supply — 0830-0474-0000

12 pin removable screw terminal connector — 0836-1279-0012

14 pin removable screw terminal connector — 0836-1280-0014

Declaration of Conformity

Series PD

Watlow Winona, Inc.
1241 Bundy Blvd.
Winona, MN 55987 USA

Declares that the following product:

Designation: **Series PD**
Model Numbers: PD (D or S) (1, 2 or 3) – (C, F, J or K) (A, C, E or K) (A, C, F, J or K) (A, C, E or K) – (0 or 1) (any three letters or numbers)
Classification: Temperature control, Installation Category II, Pollution degree 2
Rated Voltage: 24V \approx (ac or dc)
Rated Frequency: 50 or 60 Hz
Rated Power Consumption: 14VA maximum

Meets the essential requirements of the following European Union Directives by using the relevant standards shown below to indicate compliance.

89/336/EEC Electromagnetic Compatibility Directive

EN 61326: 1997 With A1, 1998, A2:2002:	Electrical equipment for measurement, control and laboratory use – EMC requirements (Industrial Immunity, Class B Emissions).
EN 61000-4-2: 1996 With A1, 1998:	Electrostatic Discharge Immunity
EN 61000-4-3: 1997:	Radiated Field Immunity
EN 61000-4-4: 1995:	Electrical Fast-Transient / Burst Immunity
EN 61000-4-5: 1995 With A1, 1996:	Surge Immunity
EN 61000-4-6: 1996:	Conducted Immunity
EN 61000-4-11: 1994:	Voltage Dips, Short Interruptions and Voltage Variations Immunity
EN 61000-3-2: ED.2. 2000:	Harmonic Current Emissions
EN 61000-3-3: 1995 With A1:1998:	Voltage Fluctuations and Flicker

73/23/EEC Low-Voltage Directive

EN 61010-1: 2001 Safety Requirements of electrical equipment for measurement, control and laboratory use. Part 1: General requirements

Raymond D. Feller III

Name of Authorized Representative

Winona, Minnesota, USA

Place of Issue

General Manager

Title of Authorized Representative

April 2003

Date of Issue



Signature of Authorized Representative

How to Reach Us

TOTAL
CUSTOMER
SATISFACTION
3 Year Warranty

Your Authorized Watlow Distributor:

Corporate Headquarters in the U.S.:

Watlow Electric Manufacturing Co.
12001 Lackland Road
St. Louis, Missouri, USA 63146
Telephone: +1 (314) 878-4600
Fax: +1 (314) 878-6814

Europe:

Watlow GmbH
Industriegebiet Heidig
Lauchwasenstr. 1, Postfach 1165
Kronau 76709 Germany
Telephone: +49 (0) 7253-9400 0
Fax: +49 (0) 7253-9400-44

Watlow France S.A.R.L.
Immeuble Somag, 16 Rue Ampère,
Cergy Pontoise CEDEX 95307 France
Telephone: +33 (1) 3073-2425
Fax: +33 (1) 3073-2875

Watlow Italy S.R.L.
Via Meucci 14,
20094 Corsico MI
Italy
Telephone: +39 (02) 4588841
Fax: +39 (02) 458-69954

Watlow Limited
Robey Close, Linby Industrial Estate,
Linby Nottingham England, NG15 8AA
Telephone: +44 (0) 115 9640777
Fax: +44 (0) 115 9640071

Latin America:

Watlow de México
Av. Fundición #5,
Col. Parques Industriales,
Querétaro, Qro. México CP-76130
Telephone: +52 (442) 217-6235
Fax: +52 (442) 217-6403

Asia/Pacific:

Watlow Australia Pty., Ltd.
23 Gladstone Park Drive,
Tullamarine, Victoria 3043 Australia
Telephone: +61 (39) 335-6449
Fax: +61 (39) 330-3566

Watlow China, Inc.
179, Zhong Shan Xi Road
Hong Qiao Cointek Bldg, Fl. 4, Unit P
Shanghai 200051 China
Telephone: +86 (21) 6229-8917
Fax: +86 (21) 6228-4654

Watlow Japan Ltd. K.K.
Azabu Embassy Heights 106,
1-11-12 Akasaka,
Minato-ku, Tokyo 107-0052 Japan
Telephone: +81 (03) 5403-4688
Fax: +81 (03) 5403-4646

Watlow Korea Co., Ltd.
3rd F. Taehong Bldg.
20-6, Seocho-gu Yangjae-dong
Seoul, Korea 137-130
Telephone: +82 (2) 575-9804
Fax: +82 (2) 575-9831

Watlow Malaysia Sdn Bhd
38B Jalan Tun Dr Awang
11900 Bayan Lepas
Penang Malaysia
Telephone: +60 (4) 641-5977
Fax: +60 (4) 641-5979

Watlow Singapore Pte. Ltd.
Ayer Rajah Crescent
#03-23, Ayer Rajah Industrial Estate
Singapore 139949
Telephone: +65 773 9488
Fax: +65 778 0323

Watlow Electric Taiwan
10F-1 No. 189
Chi-Shen 2nd Road,
Kaohsiung, Taiwan
Telephone: +886 (7) 288-5168
Fax: +886 (7) 288-5568