

Series SD6 PID with DeviceNet (Addendum)

Watlow's Series SD6 with DeviceNet offers excellent control and application flexibility in a 1/16th DIN panel mount package.

The Series SD6 with DeviceNet has successfully passed the rigorous testing requirements of ODVA and is also SEMI-SIG compliant.

This single-channel controller includes a universal sensor input with two outputs that can be configured as heat, cool, or alarm. The DeviceNet communications interface is supplied with either of two standard connectors, a closed style M12 (Semi-SIG compliant) or an open style connector.

The Series SD6 with DeviceNet is only available with one or two outputs.

Ordering Information and Model Numbers

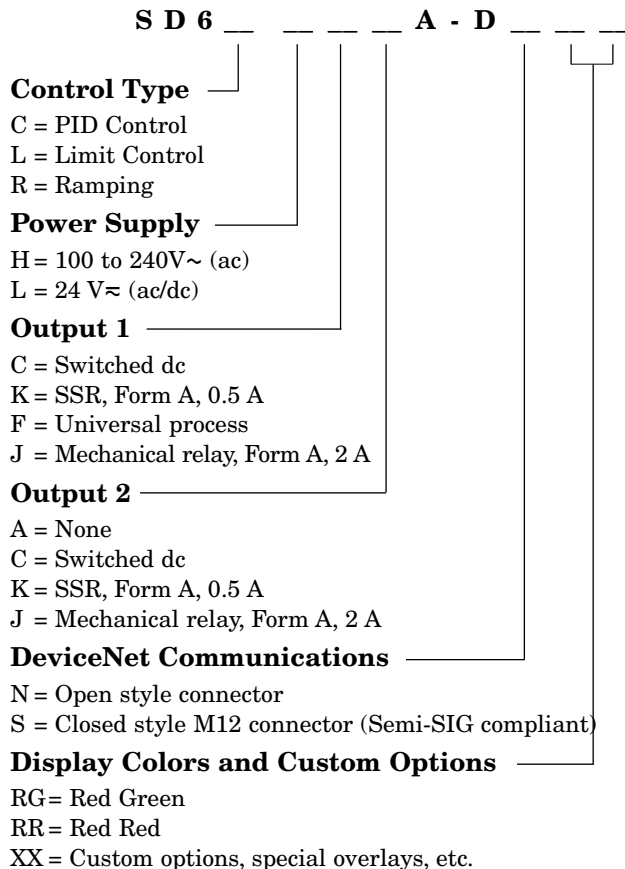

Keys and Display

Diagnostic Indicator Lights

Provide operating and diagnostic information about the module (MOD) and network (NET). SD6C-XXXXA-DXXX shown.

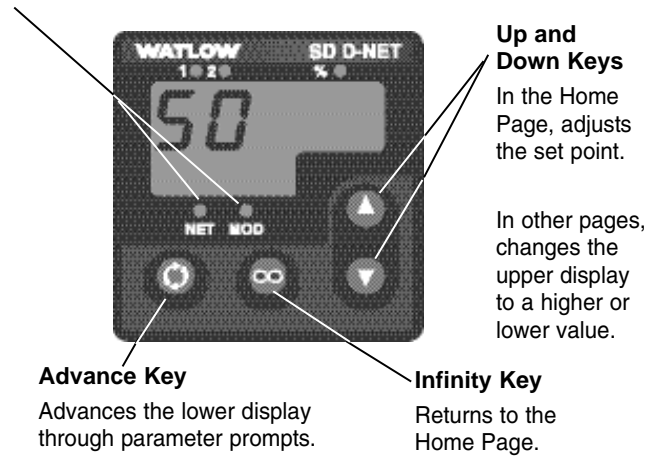

Table 1. Module Status (MOD) Indicator Light

Indicator Light	Description
Off	No power is applied to the device.
Flashing Green-Red	The device is performing a self-test.
Flashing Red	The controller is in Auto mode and an input error condition ($E_{r.in}$) exists. This indication does not occur if the controller is in the Manual mode when an input error occurs.
Red	A checksum error ($E_{r.CS}$) has occurred.
Green	The device is operating normally.

Table 2. Network Status (NET) Indicator Light

Indicator Light	Description
Off	The device is not online. The device has not completed the duplicate MAC ID test yet. The device may not be powered. Look at Table 1, Module Status Indicator Light.
Green	The device is online and has connections in the established state. For a Group 2 Only device it means that the device is allocated to a Master.
Red	Failed communication device. The device has detected an error that has rendered it incapable of communicating on the network (duplicate MAC ID or Bus-off).
Flashing Green	The device is online, but no connection has been allocated or an explicit connection has timed out.
Flashing Red	A poll connection has timed out.



Dimensions

Series SD6 open style connector

Back

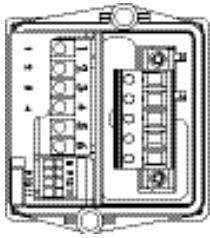

Left Side

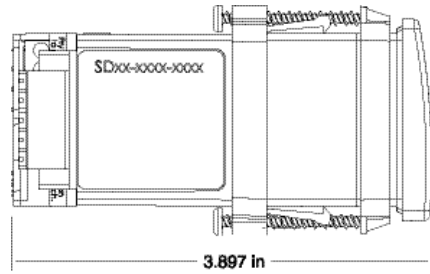

Series SD6 closed style M12 connector, (Semi-SIG compliant)

Back

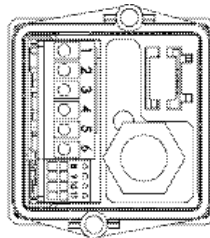

Left Side

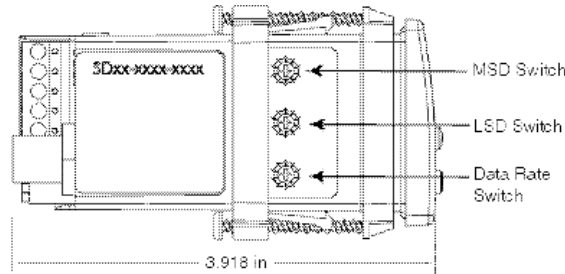

Switch Label

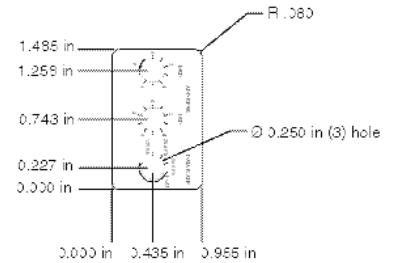

Node Address Switches

Set the controller's MAC ID with the top two rotary switches on the side of the case. Set the most significant digit (MSD) with the top switch and the least significant digit (LSD) with the middle switch. For example, to set the address to 23, set the MSD to 2 and the LSD to 3. If the switch is set to "PGM", the last node address at power down is used.

(0 - 63) can be selected from the front panel (Setup Menu) or via the software. The factory default values are as follows:

Baud Rate = 125KB

Address = 63

Data Rate Switch

Set the Data Rate switch (below the address switches) to the network data rate. If the switch is set to "PGM", the last baud rate at power down is used.

Closed style (M12 connector) only (SD6X-XXXX-DSXX)

The three switches on the side of the unit define the address and baud rate (See picture above for closed style SD6). If the MSD switch is in the "P" (Program) position, the address will be software programmable. Likewise, if the Data Rate switch is set to "PGM" the data rate will be software programmable. On power down, the unit will always come back into the network with its last known baud rate and address. The factory default values are as follows:

Baud Rate = 500KB

Address = 63

Communications Setup

Open style connector only (SD6X-XXXX-DNXX)

Baud Rate (125, 250, 500KB) and Node Address or MAC ID

Pinout

Table 3. DeviceNet Connectors

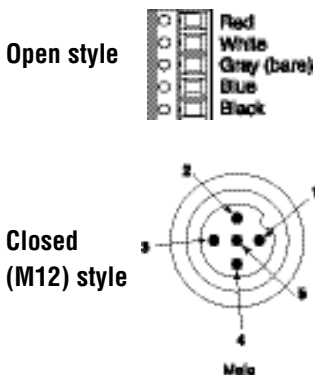

Pin Open style	Pin M12 Closed style	Signal	Function
Black	3	V-	DeviceNet power return
Blue	5	CAN_L	Negative side of the DeviceNet bus
Grey (bare)	1	Drain	Shield interconnect
White	4	CAN_H	Positive side of the DeviceNet bus
Red	2	V+	DeviceNet power

DeviceNet Communications

This appendix describes the DeviceNet protocol as it is implemented in the Series SD6 controller. It primarily describes the objects and attributes accessible via the DeviceNet protocol. It may be necessary to refer to the DeviceNet specification as a compliment to the information found here.

DeviceNet Overview

The SD6 controller supports the object-based modeling used in the DeviceNet concepts. This product is configured as a Group 2 Only Slave device using the Predefined Master/Slave Connection Set.

There are two main categories of objects, DeviceNet Objects and Application Objects. DeviceNet objects handle what is necessary for networking and communications. Application Objects have access to the SD6 controller's parameters and data.

Addressing

All data is referenced based upon a four-part definition: Node (MAC ID) + Class + Instance + Attribute.

Table 4. Four Components to an Address, with Ranges

Node Address (MAC ID)	[0 to 63]
Class ID	[1 to 255]
Instance ID	[0 to 255]
Attribute ID	[1 to 255]

Data Types

The descriptions of attributes in the following sections includes the data type for each. Table 5 lists and describes these data types.

Table 5. Descriptions of Elementary Data Types

Data Type Name	Data Type Description
BOOL	Logical Boolean with values TRUE and FALSE
BYTE	Bit string — 8 bits
EPATH	DeviceNet path segments
INT	Signed 16-bit integer value
SHORT_STRING	Character string (1 byte per character, 1 byte length indicator)
UDINT	Unsigned 32-bit integer value
UINT	Unsigned 16-bit integer value
USINT	Unsigned 8-bit integer value
WORD	Bit string — 16 bits

Group 2 Only Server

A slave (server) device that is UCMM incapable and must use the Predefined Master/Slave Connection Set to establish communications (at a minimum, the Predefined Master/Slave Explicit Messaging Connection must be supported). A Group 2 Only device can transmit and receive only those identifiers defined by the *Predefined Master/Slave Connection Set* (reference DeviceNet Spec., Vol. 1, Sec. 2).

Master/Slave Connections

The SD6 supports the *Predefined Master/Slave Connection Set* (refer to DeviceNet Specification, Vol. 1, Sec. 7). The general model calls for the utilization of an Explicit Messaging Connection to manually create and configure Connection Objects within each connection end-point. This chapter uses the general model as a basis for the definition of a set of connections that facilitate communications typically seen in a master-slave relationship. These Connections are referred to collectively as the *Predefined Master/Slave Connection Set*.

The **master** is the device that gathers and distributes I/O data for the process controller. **Slaves** are the devices from which the master gathers I/O data and to which the master distributes I/O data. The master “owns” the slaves whose MAC IDs appear in its scan list. To determine with what slaves it will communicate, the master examines its scan list and sends commands accordingly. Except for the Duplicate MAC ID Check, a slave cannot initiate any communication before being told by the master to do so.

Electronic Data Sheet (EDS)

The EDS allows a configuration tool to automate the device configuration process. The EDS specification provides an open standard for device configuration and compatibility among all DeviceNet products. (Refer to the DeviceNet Specification, Vol. 1, Chapter 4). You can obtain a copy of the EDS at www.watlow.com and search on keywords *SD EDS*, request a copy by sending an e-mail to wintechsupport@watlow.com or by calling an Application Engineer at +1 (507) 494-5656 between 7 a.m. and 5 p.m. Central Standard Time (CST).

DeviceNet Objects

The following sections describe the standard DeviceNet objects and the SD6-specific application objects.

Identity Object

Class Code: 01hex

The Identity object provides identification information for the device. This includes the device manufacturer, product name, product type, serial number and revision.

Refer to the DeviceNet Specification (Vol. II, Sec. 6-2) for complete requirements.

Status Attribute – This is a bit field that represents the current status of the device. Two of the bits in the Status attribute, the Minor Recoverable Fault and Major Recoverable Fault bits, shall never be set. In accordance with the semiconductor industry standard, all module level faults are considered to be unrecoverable faults.

Table 6. Identity Object Revision History

Revision	Description
01	Initial Release

Table 7. Identity Object Class Attributes

Number	Access Rule	Namer	Name	DeviceNet Data Type	Description of Attribute	Semantics of Values

Table 8. Identity Object Instance Attributes

Attribute #	Access Rule	Name	DeviceNet Data Type	Description of Attribute	Semantics of Values
1	Get	Vendor ID	UNIT	Identification of each vendor by number. This is Vendor ID 153.	See "Semantics" DeviceNet Spec, Vol. II, Sec. 6-2.2
2	Get	Product Type	UNIT	Identification of general type of product. This is Type 0.	See "Semantics" DeviceNet Spec, Vol. II, Sec. 6-2.2
3	Get	Product Code	UNIT	WATLOW SD6-DN, CODE IS 105 WATLOW SD6-DS, CODE IS 104	See "Semantics" DeviceNet Spec, Vol. II, Sec. 6-2.2
4	Get	Revision	STRUCT of:	Revision of the item the Identity Object represents	See "Semantics" DeviceNet Spec, Vol. II, Sec. 6-2.2
5	Get	Status	WORD	Summary status of device	See "Semantics" DeviceNet Spec, Vol. II, Sec. 6-2.2
6	Get	Serial Number	UDINT	Serial number of device Set in accordance with a Watlow manufacturing guidelines.	See "Semantics" DeviceNet Spec, Vol. II, Sec. 6-2.2
7	Get	Product Name	SHORT_STRING	Human readable ID: "Watlow Series SD6"	See "Semantics" DeviceNet Spec, Vol. II, Sec. 6-2.2

Class Services: NONE

Instance Services:

- RESET (O,1) GET ATTRIBUTE SINGLE

DeviceNet Object

Class Code: 03hex

The DeviceNet Object is used to provide the configuration and status of a physical attachment to DeviceNet.

The *MACID* attribute provides the network address for the device. If the rotary switches used to specify the device MACID are set to a valid MACID, i.e. a value from 0 to 63, the MACID attribute shall have Get Only access. If the rotary switches are set to the programmable mode, the MACID attribute shall have Get and Set access.

The *Baud Rate* attribute specifies the data rate for the device. If the rotary switch used to set the data rate specifies a valid data rate, i.e. 125, 250, or 500K Baud, the Baud Rate attribute shall have Get Only access. If the rotary switches are set to the software programmable mode, the MACID shall have Get and Set access.

The *Allocate Master/Slave Connection Set* service of the DeviceNet object shall be a required service for all devices. This implies a requirement that all devices are Group 2 devices on the DeviceNet network. Additionally, all devices shall support, as a minimum, the Explicit connection and the I/O Poll connection in the Master/Slave connection set.

The *Release Master/Slave Connection Set* service of the DeviceNet object shall be a required service.

Refer to the DeviceNet Specification (Vol. I, Sec. 5-5) for complete requirements.

Table 9. DeviceNet Object Revision History

Revision	Description
01	Initial Release
02	Modification of Baud Rate Attribute Behavior

Table 10. DeviceNet Object Class Attributes

Attribute #	Access Rule	Name	DeviceNet Data Type	Description of Attribute	Semantics of Values
1	Get	Revision	UINT	Revision of this object	The revision level of this object. This is now at 2.

Table 11. DeviceNet Object Instance Attributes

Attribute #	Access Rule	Name	DeviceNet Data Type	Description of Attribute	Semantics of Values
1	Get/Set*	MACID	USINT	Node Address	Range 0.. 63
2	Get/Set*	Baud Rate	USINT	Baud Rate	Range 0.. 2
4	Get	Bus-Off Counter	USINT	Number of times CAN went to the bus-off state	Range 0.. 255
5	Get	Allocation Information Allocation Choice Byte Master's MAC ID	STRUCT of: BYTE USINT	See Vol. I, Section 5-5.4.2. MAC ID of Master (from Allocate)	Range 0.. 63, 255 Modified via Allocate only

Class Services: GET ATTRIBUTE SINGLE

Instance Services: *SET ATTRIBUTE SINGLE (when MACID or BAUD RATE in PRG MODE), GET ATTRIBUTE SINGLE, ALLOCATE M/S CONNECTION SET, RELEASE M/S CONNECTION SET.

Assembly Object – “Static”

Class Code: 04hex

The Assembly Object binds attributes of multiple objects, which allows data to or from each object to be sent or received over a single connection. Assembly objects can be used to bind input data or output data. The terms “input” and “output” are defined from the network’s point of view.

An input will produce data on the network and an output will consume data from the network.

The term “Static” implies: assemblies with member lists defined by the device profile or by the manufacturer of the product. The Instance number, number of Members, and member list are fixed.

Table 12. Assembly Object Revision History

Revision	Description
01	Initial Release
02	Class-specific Service Code 4B and 4C obsolete

Table 13. Assembly Object Instance Attributes

Attribute #	Access Rule	Name	DeviceNet Data Type	Description of Instance	Semantics of Values
3	Get/Set	Data	Array of BYTES	See description below	See description below

Instance #	Access Rule	Name	DeviceNet Data Type	Description of Instance	Semantics of Values
100	Get/Set	Poll Output	LONG + USINT	Poll Output	See Poll output in section 6.2.4
101	Get	Poll Input	USINT + LONG + USINT + USINT	Poll Input	See Poll input in section 6.2.4

Poll Connection

The poll connection allows the master to write set point and process value in one connection. It also allows the reading of all process value, set point and alarm status.

Table 14. Static Input – Instance 101 in the Assembly Object - 7 bytes

Byte(s)	Parameter and Description	Size of Data	Range
0	Exception Status Byte - Byte reserved for future use.	USINT	Always returns a value of zero.
1-4	Process Value- Actual value of process input	DINT	-1999.000 to 9999.000
5	Alarm Status - Indicates when alarm outputs are in alarm condition. Breakdown of byte: Bit 0: alarm low 1 status Bit 1: alarm high 1 status Bit 2: alarm low 2 status Bit 3: alarm high 2 status Bit 4 to bit 7: unused	USINT	For each bit: (0) None (1) Alarm
6	Control Mode - Breakdown of byte: Bit 0: monitor the auto / manual status. Bit 1 to bit 7: unused	USINT	(0) Auto mode (1) Manual mode

Table 15. Static Output – Instance 100 in the Assembly Object - 5 bytes

Byte(s)	Parameter and Description	Size of Data	Range
0-3	Closed Loop Set Point - Control set point used in the auto mode	DINT	-1999.000 to 9999.000
4	Control Modes - Breakdown of byte:	USINT	
	Bit 0: Selects whether the controller is in the auto or manual mode.		(0) Auto mode (1) Manual mode
	Bit 1: Selects whether the set point adjustment is done via the SD front panel or through DeviceNet		(0) DeviceNet (1) SD front panel
	Bit 2: Selects whether Auto/Manual mode selection is done via the SD front panel or through DeviceNet.		(0) DeviceNet (1) SD front panel
	Bit 3 to Bit 7: Not used		N/A

Class Services: NONE

Instance Services:

- 0x0E GET ATTRIBUTE SINGLE
- 0x10 SET ATTRIBUTE SINGLE

Additional Poll Connection information:

- In the event of the input error, a valid process value reading is no longer available. The poll connection will return a value of 9999.999 for the process value while the error condition exists.
- Bit 1 and bit 2 of byte 4 in the output poll connection select whether set point and auto / manual mode values are changed from the SD's front panel or else over DeviceNet through the poll connection. Setting the bit to "zero" will relinquish control of the parameter to the DeviceNet master device (typically the master is a PLC). Setting the bit to "one" will retain control of the parameter locally at the front panel of the Series SD controller. If there is a loss of communications, control of auto / manual mode and adjustment of set point will automatically return to the Series SD front panel regardless of the settings of byte 4 in the output poll connection.

Connection Object

Class Code: 05hex

The Connection Class allocates and manages the internal resources associated with both I/O and Explicit Messaging Connections. The specific instance generated by the Connection Class is referred to as a Connection Instance or a Connection Object.

A Connection Object within a particular module actually represents one of the end-points of a Connection. It is possible for one of the Connection end-points to be configured and "active" (e.g., transmitting) without the other end-point(s) being present. Connection Objects are used to model the communication specific characteristics of a particular application-to-application relationship. A specific Connection Object Instance manages the communication-specific aspects related to an end-point.

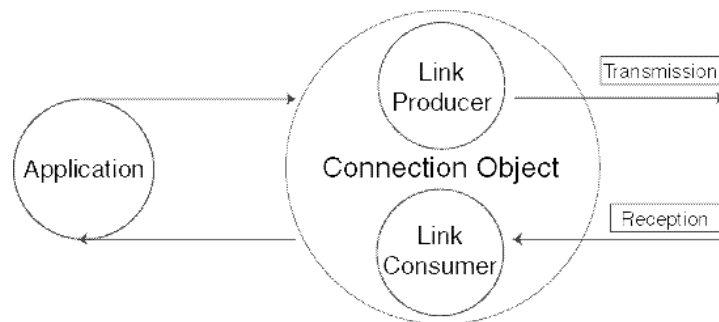

Explicit Connection

The Explicit Connection Object defines the configuration for the Explicit connection to the device. The Explicit Connection object is an instance of the Connection Object defined in the DeviceNet Specification. All devices that are compliant with the DeviceNet Specification must support at least one instance of the Connection object with a connection type of Explicit.

I/O Connection

I/O Connection objects define the configuration for the I/O connections to the device. Each I/O Connection object is an instance of the Connection object defined in the *DeviceNet Specification*. All devices must be Group 2 devices and must support, as a minimum, the I/O Poll connection in the Master/Slave connection set.

Watchdog Timeout Action Attribute defines the action performed by the I/O Connection object in the event the Inactivity/watchdog Timer for the connection expires. For the I/O Connection object, Auto Reset shall be an invalid value for the Watchdog Timeout Action attribute. (ref. SIG Specification sec. 4.1.5.1.1)

Produced Connection Path Attribute defines the Application object class, instance, and attribute that produces data over the I/O connection. For all I/O connections, the Produced Connection Path shall be a Logical Segment, as defined in the DeviceNet Specification, and shall point to the Data Attribute of an Assembly object. The behavior of the device shall be such that, if the Produced Connection Path attribute is modified, the **Produced Connection Size Attribute** shall be modified internally to accurately reflect the size of the assembly produce by the I/O connection. For all I/O connection objects in the Master/Slave Connection Set, if the Produced Connection Path attribute is modified, the new attribute value shall be saved in Non-Volatile (NV) memory and shall be the default value when the connection is allocated. (ref. SIG Specification sec. 4.1.5.1.2).

Produced Connection Size Attribute specifies the maximum number of data bytes produced over the I/O connection. The Produced Connection Size attribute shall have *Get Only* access for all I/O connection objects. The Produced Connection Size attribute shall accurately reflect the size of the assembly produced over the I/O connection. (ref. SIG Specification sec. 4.1.5.1.3).

Consumed Connection Path Attribute defines the Application object class, instance, and, optionally, attribute that consumes data received over the I/O connection. For all I/O connections over which the device is the Server (as specified by the Direction field of the Transport Class Trigger attribute), then special requirements as defined in the Semi SIG specification shall be followed. (ref. SIG Specification sec. 4.1.5.1.4)

Consumed Connection Size Attribute specifies the maximum number of data bytes consumed by the I/O connection objects. The Consumed Connection Size attribute shall accurately reflect the size of the assembly consumed by the I/O connection, as specified by the Consumed Connection Path attribute of the Data With ACK Path List attribute of the Acknowledge Handler object. (ref. SIG Specification sec. 4.1.5.1.5)

Refer to the Semi SIG specification (Sec. 4.1.4/5) for Semi requirements.

Refer to the DeviceNet Specification (Vol. II, Sec. 6-3) for complete requirements.

Table 16. Connection Object Revision History

Revision	Description
01	Initial Release

Table 17. Connection Object Class Attributes

Attribute #	Access Rule	Name	DeviceNet Data Type	Description of Attribute	Semantics of Values

Table 18. Connection Object Instance Attributes

Attribute #	Access Rule	Name	DeviceNet Data Type	Description of Attribute	Semantics of Values
1	Get	State	USINT	State of the object	
2	Get	Instance Type	USINT	Indicates either I/O or Messaging	
3	Get	Transport Class Trigger	BYTE	Defines behavior of the Connection	
4	Get	Produced Connection ID	UINT	Placed in CAN Identifier Field when the Connection transmits	
5	Get	Consumed Connection ID	UINT	CAN Identifier Field value that denotes message to be received	
6	Get	Initial Comm Characteristics	BYTE	Defines the Message Group(s) across which productions and consumption associated with this Connection when it occurs	
7	Get	Produced Connection Size	UNIT	Maximum number of bytes transmitted across this Connection	
8	Get	Consumed Connection Size	UNIT	Maximum number of bytes received across this Connection	
9	Get/Set	Expected Packet Rate	UNIT	Will round up to the next 100 mSec. Increment.	
12	Get/Set	Watchdog Timeout Action	USINT	Defines how to handle Inactivity/Watchdog timeouts	For Explicit Connection only: 1 = Auto Delete 3 = Deferred Delete
13	Get	Produced Connection Path Length	UINT	Number of bytes in the Produced Connection Path Attribute	
14	Get	Produced Connection Path	EPATH	Specifies the Application Object(s) whose data is to be produced by this Connection Object. See Appendix I, DeviceNet Specification	
15	Get	Consumed Connection Path Length	UINT	Number of bytes in the Consumed Connection Path Length	
16	Get	Consumed Connection Path	EPATH	Specifies the Application Object(s) that are to receive data consumed by this Connection Object. See Appendix I, DeviceNet Specification	

Class Services: NONE

Instance Services:

- 0x0E GET ATTRIBUTE SINGLE
- 0x10 SET ATTRIBUTE SINGLE
- 0x05 RESET SERVICE

Home Object

Class Code: 64hex

The Home Object provides access to parameters used for the default display of the Series SD6.

Table 19. Home Object Revision History

Revision	Description
01	Initial Release

Table 20. Home Object Class Attributes

Attribute #	Access Rule	Name	DeviceNet Data Type	Description of Attribute	Semantics of Values
1	Get	Revision	UINT	Revision of this object	The revision level of this object (currently 1)
2	Get	Max Instance	UINT	Max allowed Instances of this object	Always 1 for this Class

Table 21. Home Object Instance Attributes

Attribute #	Access Rule	Name	DeviceNet Data Type	Description of Attribute	Semantics of Values
100	Get	Process Value	DINT	Current process value	-1999 to 9999 (*1000), °C or units
101	Get/Set	Closed Loop Set Point	DINT	Current closed loop set point	Range is from set point low limit to set point high limit
102	Get	Filtered Process Value	DINT	Filtered process value	-1999 to 9999 (*1000), °C or units
103	Get/Set	Open Loop Output Power	INT	Current open loop output power (used in manual mode)	-100.0 to 0.0% (*100) if any output is set to cool; 0.0 to 100.0% (*100) if any output is set to heat
104	Get	Current Ramp Set Point	DINT	Current working control set point for the ramp that is in process	-1999 to 9999 (*1000), °C or units
106	Get	Input Error	UINT	There is an analog input error	(0) No error (1) Error
107	Get	Alarm Low 1 Status	BOOLEAN	There is an alarm 1 low side alarm	(0) None (1) Alarm
108	Get	Alarm High 1 Status	BOOLEAN	There is an alarm 1 high side alarm	(0) None (1) Alarm
109	Get	Alarm Low 2 Status	BOOLEAN	There is an alarm 2 low side alarm	(0) None (1) Alarm
110	Get	Alarm High 2 Status	BOOLEAN	There is an alarm 2 high side alarm	(0) None (1) Alarm

Class Services:

- 0x0E GET ATTRIBUTE SINGLE

Instance Services:

- 0x0E GET ATTRIBUTE SINGLE
- 0x10 SET ATTRIBUTE SINGLE

NOTE: All successful Explicit Message Responses from a SET service will contain no data. The response will be a two-byte message containing the requester’s MAC ID and Service Code (with R/R bit set).

Setup Object

Class Code: 65hex

The Setup Object provides access to parameters that define controller functions.

Table 22. Setup Object Revision History

Revision	Description
01	Initial Release

Table 23. Setup Object Class Attributes

Attribute #	Access Rule	Name	DeviceNet Data Type	Description of Attribute	Semantics of Values
1	Get	Revision	UINT	Revision of this object	The revision level of this object (currently 1)
2	Get	Max Instance	UINT	Max allowed Instances of this object	1 for this Class

Table 24. Setup Object Instance Attributes

Attribute #	Access Rule	Name	DeviceNet Data Type	Description of Attribute	Semantics of Values
100	Get/Set	Sensor Type	USINT	Analog input sensor type	(0) Thermocouple (default) (1) RTD (2) MA (3) VOLT
101	Get/Set	Thermocouple Linearization	USINT	Thermocouple Type	(0) J (1) K (default) (2) T (3) E (4) N (5) C (6) D (7) PTII (8) R (9) S (10) B
102	Get/Set	Temperature Units	USINT	Temperature Units	(0) °F (1) °C (default)
103	Get/Set	Temperature Decimal Places	USINT	Thermocouple/RTD precision	(0) 0 (default) (1) 0.0
104	Get/Set	Process Decimal Places	USINT	Process precision	(0) 0 (default) (1) 0.0 (2) 0.00 (3) 0.000
105	Get/Set	InfoSense™	USINT	Enables the sensor feature, which synchronizes the controller with a Watlow sensor	(0) NO (default) (1) YES
106	Get/Set	InfoSense™ 1	UINT	Set sensor point 1 code	0 to 999 (default is 500)
107	Get/Set	InfoSense™ 2	UINT	Set sensor point 2 code	0 to 999 (default is 500)
108	Get/Set	InfoSense™ 3	UINT	Set sensor point 3 code	0 to 999 (default is 500)

Attribute #	Access Rule	Name	DeviceNet Data Type	Description of Attribute	Semantics of Values
109	Get/Set	InfoSense™ 4	UINT	Set sensor point 4 code	0 to 999 (default is 500)
110	Get/Set	Process Scale Low mA	UDINT	Set the low scale for process input	0.00 to 20.00 mA (* 1000) (when Sensor Type set to mA, default = 4.00 mA)
111	Get/Set	Process Scale Low Volts	UDINT	Set the low scale for process input	0.0 to 10.00 V (* 1000) (when Sensor Type set to Volt, default = 0.00 V)
112	Get/Set	Process Scale High mA	UDINT	Set the high scale for process input	0.00 to 20.00 mA (* 1000) (when Sensor Type set to mA, default = 20.00 mA)
113	Get/Set	Process Scale High Volts	UDINT	Set the high scale for process input	0.0 to 10.00 V (* 1000) (when Sensor Type set to Volt, default = 0.00 V)
114	Get/Set	Units Scale Low	DINT	Set the low range for process input units	-1999 to 9999 (* 1000) (default = -1999)
115	Get/Set	Units Scale High	DINT	Set the high range for process input units	-1999 to 9999 (* 1000) (default = 9999)
116	Get/Set	Set Point Low Limit Thermocouple	DINT	Set the low range for the set point	Minimum operating range (of sensor) to Set Point High Limit – 0.001 (if Sensor Type = Thermocouple, default = min. for K-Thermocouple) (* 1000)
117	Get/Set	Set Point Low Limit RTD	DINT	Set the low range for the set point	-328 to Set Point High Limit – 0.001 (if Sensor Type = RTD, default = -328) (* 1000)
118	Get/Set	Set Point Low Limit mA and volts	DINT	Set the low range for the set point	-1999 to Set Point High Limit – 0.001 (if Sensor Type = V or mA, default = -1999) (* 1000)
119	Get/Set	Set Point High Limit Thermocouple	DINT	Set the high range for the set point	Units Scale Low to max operating range of sensor, if Input Type = Thermocouple (default = max operating range for K-Thermocouple) (* 1000)
120	Get/Set	Set Point High Limit RTD	DINT	Set the high range for the set point	Set Point Low Limit + 0.001 to 1472, if Input Type = RTD (default = 1472) (* 1000)

Attribute #	Access Rule	Name	DeviceNet Data Type	Description of Attribute	Semantics of Values
121	Get/Set	Set Point High Limit mA and volts	DINT	Set the high range for the set point	Set Point Low Limit + 0.001 to 9999, if Input Type = mA or Volt (default = 9999) (* 1000)
122	Get/Set	Input Filter	USINT	Select filtering action	(1) OFF (no filtering, default) (1) Filter display only (2) Filter control input only (3) Filter both
123	Get/Set	Filter Value	UDINT	Set the input filter value, units in seconds	0.0 to 60.0 (default = 0.0) seconds (* 1000)
124	Get/Set	Output 1 Function	USINT	Set the output 1 function	(0) OFF (1) Process Alarm (2) Deviation Alarm (3) Heat Control (default) (4) Cool Control
125	Get/Set	Control Method 1	USINT	Set the output 1 control type Only used with PID control	(1) Fixed Timed Base (default) (1) Variable Time Base
126	Get/Set	Fixed Time Base 1	USINT	Set the time base for fixed time based control	1.0 to 60.0 if Output 1 is a mechanical relay 0.1 to 60.0 if Output 1 is not a mechanical relay Defaults: 20.0 mechanical relay 5.0 solid-state relay 1.0 switched DC
127	Get/Set	Power Limit 1	UINT	Set the maximum power output for a control output	0.0 to 100% (default = 100%)
128	Get/Set	Output Power Scale Low 1	USINT	Set the low end of the range within which the output will scale	0 to 100% (default = 0)
129	Get/Set	Output Power Scale High 1	USINT	Set the high end of the range within which the output will scale	0 to 100% (default = 100)
130	Get/Set	Output Non-linear Function 1	USINT	Select a non-linear output curve to match the response of your system	(0) OFF (default) (1) Curve 1 (2) Curve 2
131	Get/Set	Analog Output 1 Units	USINT	Set the analog output units	(0) Milliampere (default) (1) Volts
132	Get/Set	Analog Output 1 Low Scale mA	UDINT	Set the low scale for analog outputs	0.00 to 20.00 mA if output is set to mA (default = 0.00) (* 1000)

Attribute #	Access Rule	Name	DeviceNet Data Type	Description of Attribute	Semantics of Values
133	Get/Set	Analog Output 1 Low Scale volts	UDINT	Set the low scale for analog outputs	0.00 to 10.00 V if output is set to Volts (default = 0.00) (* 1000)
134	Get/Set	Analog Output 1 High Scale mA	UDINT	Set the high scale for analog outputs	0.00 to 20.00 mA if output is set to mA (default = 20.00 mA) (* 1000)
135	Get/Set	Analog Output 1 High Scale volts	UDINT	Set the high scale for analog outputs	0.0 to 10.00 V if output is set to Volts (default = 10.00 V) (* 1000)
136	Get/Set	Output 2 Function	USINT	Set the output 2 function	(0) OFF (1) Process Alarm (2) Deviation Alarm (3) Heat Control (default) (4) Cool Control
137	Get/Set	Control Method 2	USINT	Set the output 2 control type Only used with PID control	(0) Fixed Timed Base (default) (1) Variable Time Base
138	Get/Set	Fixed Time Base 2	UDINT	Set the time base for fixed time based control	1.0 to 60.0 if Output 2 is a mechanical relay 0.1 to 60.0 if Output 2 is not a mechanical relay (* 1000) Defaults: 20.0 mechanical relay 5.0 solid-state relay 1.0 switched DC
139	Get/Set	Power Limit 2	UINT	Set the maximum power output for a control output.	1.0 to 100.0% (default = 100.0%)
140	Get/Set	Output Power Scale Low 2	UINT	Set the low end of the range within which the output will scale.	0 to 100% (default = 0)
141	Get/Set	Output Power Scale High 2	UINT	Set the high end of the range within which the output will scale.	0 to 100% (default = 100)
142	Get/Set	Output Non-linear Function 2	USINT	Select a non-linear output curve to match the response of your system.	(0) OFF (default) (1) Curve 1 (2) Curve 2
143	Get/Set	Alarm 1 Hysteresis	UDINT	Set the hysteresis for an alarm. This determines how far into the safe region the input needs to move before the alarm can be cleared.	1.0 to 999.0 (* 1000) (default = 1.0)
144	Get/Set	Alarm 1 Logic	BOOLEAN	Select the alarm output condition in the alarm state.	(0) Closed on alarm (default) (1) Open on alarm

Attribute #	Access Rule	Name	DeviceNet Data Type	Description of Attribute	Semantics of Values
145	Get/Set	Alarm 1 Latching	BOOLEAN	Turn alarm latching on or off.	(0) OFF (default) (1) ON
146	Get/Set	Alarm 1 Silencing	BOOLEAN	Turn alarm silencing on or off.	(0) No silencing (default) (1) Silencing
147	Get/Set	Alarm 1 Message	BOOLEAN	Display an alarm message when an alarm is active.	(0) OFF (no message) (1) ON (default)
148	Get/Set	Alarm 2 Hysteresis	UDINT	Set the hysteresis for an alarm. This determines how far into the safe region the input needs to move before the alarm can be cleared.	1.0 to 999.0 (* 1000) (default = 1.0)
149	Get/Set	Alarm 2 Logic	BOOLEAN	Select the alarm output condition in the alarm state.	(0) Closed on alarm (default) (1) Open on alarm
150	Get/Set	Alarm 2 Latching	BOOLEAN	Turn alarm latching on or off.	(0) OFF (default) (1) ON
151	Get/Set	Alarm 2 Silencing	BOOLEAN	Turn alarm silencing on or off.	(0) No silencing (default) (1) Silencing
152	Get/Set	Alarm 2 Message	BOOLEAN	Display an alarm message when an alarm is active.	(0) OFF (no message) (1) ON (default)
153	Get/Set	Units of Measurement	BOOLEAN	Set the type of units used for the PID control parameters.	(0) US (default) (1) SI
154	Get/Set	Input Error Latching	BOOLEAN	Turn the input error latching on or off.	(0) OFF (default) (1) ON
155	Get/Set	Input Error Failure Mode	USINT	Set the input error failure mode when an error is detected and the control changes to manual mode.	(0) OFF (0% power) (1) Bumpless (current power level, default) (2) Manual (fixed power level)
156	Get/Set	Input Error Power	INT	Set the manual power level when an input error causes a change to manual mode.	-100.0 to 100.0%

Attribute #	Access Rule	Name	DeviceNet Data Type	Description of Attribute	Semantics of Values
157	Get/Set	Active Displays	USINT	Select which display are active.	(0) Both displays (default) (1) Lower display only (2) Upper display only
158	Get/Set	Ramping Mode	USINT	Select when the control set point ramps to the defined end set point.	(0) OFF (default) (1) Ramps on start-up (2) Ramps on any set point change
159	Get/Set	Ramp Scale	BOOLEAN	Select the scale of the ramp rate.	(0) Degrees / hour (default) (1) Degrees / minute
160	Get/Set	Ramp Rate	UDINT	Set the rate for the set point ramp.	0 to 9999 (* 1000) (default = 100)
161	Get/Set	Lockout	USINT	Set the security level for the user interface.	(0) No Lockout (default) (1) Set Point, Auto/Manual, Alarms, only (2) Set Point, Auto/Manual, only (3) Set Point only (4) Full Lockout
162	Get/Set	Alarm Acknowledge 1	BOOLEAN	Alarm acknowledge for output 1.	(0) No (1) Yes
163	Get/Set	Alarm Acknowledge 2	BOOLEAN	Alarm acknowledge for output 2.	(0) No (1) Yes
164	Get/Set	AC Line Frequency	BOOLEAN	Sets the frequency of the applied AC line source	(0) - 60 (default) (1) - 50
165	Get/Set	Profile Type	BOOLEAN	Sets the profile ramp to time based or rate based	(0) - time based (default) (1) - ramp based
166	Get/Set	Profile Start	BOOLEAN	Selects where the profile begins the starting set point, current static set point or process temperature.	(0) - set point (default) (1) - process
167	Get/Set	Guaranteed Soak Deviation Enable	BOOLEAN	Enables the guaranteed soak deviation function in profiles	(0) - disabled (default) (1) - enabled
168	Get/Set	Guaranteed Soak Deviation Value	UDINT	Sets the value of deviation allowed	1 to 999 (*1000) (default = 1)
169	Get/Set	Process Scale Low mV	UDINT	Set the low scale for process input	0.00 to 50.00 mV (*1000) (when Sensor Type set to mV, default = 0.00 mV)

Attribute #	Access Rule	Name	DeviceNet Data Type	Description of Attribute	Semantics of Values
170	Get/Set	Process Scale High mV	UDINT	Set the high scale for process input	0.00 to 50.00 mV (*1000) (when Sensor Type set to mV, default = 50.00 mV)
171	Get/Set	Process Input Low error mA	INT	Sets the low process value that will cause an error to occur for the process input	-1.00 to 10.00 mA (*100) (Default = -1.00 mA)
172	Get/Set	Process Input Low error Volts	INT	Sets the low process value that will cause an error to occur for the process input	-1.00 to 5.00 V (*100)(Default = -1.00 V)
173	Get/Set	Process Input Low error mV	INT	Sets the low process value that will cause an error to occur for the process input	-1.00 to 25.00 mV (*100) (Default = -1.00 mV)
174	Get/Set	Process Input High error mA	UINT	Sets the high process value that will cause an error to occur for the process input	10.00 to 21.00 mA (*100) (Default = 21.00 mA)
175	Get/Set	Process Input High error Volts	UINT	Sets the high process value that will cause an error to occur for the process input	5.00 to 11.00 V (*100) (Default = 11.00V)
176	Get/Set	Process Input High error mV	UINT	Sets the high process value that will cause an error to occur for the process input	25.00 to 51.00 mV (*100) (Default = 51.00mV)
177	Get/Set	Output 1 Retransmit Source	BOOLEAN	Set the control variable that the retransmit signal represents	(0) - Process (default) (1) - Set Point
178	Get/Set	Output 1 Retransmit Low Scale	DINT	Set the low scale for the retransmit output	-1999.0 to 9999.0 (*1000) (Default = 0)
179	Get/Set	Output 1 Retransmit High Scale	DINT	Set the high scale for the retransmit output	-1999.0 to 9999.0 (*1000) (Default = 500)
180	Get/Set	Output 1 Retransmit Offset	DINT	Set the high scale for the process output	-999.0 to 999.0 (*1000) (Default = 0)
181	Get/Set	RTD Linearization	USINT	RTD type	(0) DIN (default) (1) Unused 1 (2) Unused 2

Class Services:

- 0x0E GET ATTRIBUTE SINGLE

Instance Services:

- 0x0E GET ATTRIBUTE SINGLE
- 0x10 SET ATTRIBUTE SINGLE

NOTE: All successful Explicit Message Responses from a SET service will contain no data. The response will be a two-byte message containing the requester's MAC ID and Service Code (with R/R bit set).

Operational Object

Class Code: 66hex

Operational Object

The Operational Object access parameters used during normal day-to-day operation.

Table 25. Revision History

Revision	Description
01	Initial Release

Table 26. Operational Object Class Attributes

Attribute #	Access Rule	Name	DeviceNet Data Type	Description of Attribute	Semantics of Values
1	Get	Revision	UINT	Revision of this object	The revision level of this object (currently 1)
2	Get	Max Instance	UINT	Max allowed Instances	Always 1 for this Class

Table 27. Operational Object Instance Attributes

Attribute #	Access Rule	Name	DeviceNet Data Type	Description of Attribute	Semantics of Values
100	Get/Set	Calibration Offset	DINT	Offset the input reading.	-999 to 999 (x 1000) (default = 0)
101	Get/Set	Autotune	BOOLEAN	Start an Autotune.	(0) OFF (default) (1) ON
102	Get/Set	Auto-Manual Mode	BOOLEAN	Set the control mode.	(0) Auto (default) (1) Manual
103	Get	Power Heat	UINT	Displays the current heat control power.	0.0 to 100.0%
104	Get	Power Cool	UINT	Displays the current cool control power.	0.0 to 100.0%
105	Get/Set	Heat Control Method	USINT	Set the heat control method.	(0) OFF (1) PID (default) (2) ON/OFF

Attribute #	Access Rule	Name	DeviceNet Data Type	Description of Attribute	Semantics of Values
106	Get/Set	Proportional Band Heat Temperature	UDINT	Set the proportional band for the heat outputs.	1 to 999°C (x1000), if Sensor Type is set to Thermocouple or RTD. (default = 25°C)
107	Get/Set	Proportional Band Heat Process	UDINT	Set the proportional band for the heat outputs.	0.001 to 999.999 units, if Sensor Type is set to mA or Volt. (default = 25.000 units)
108	Get/Set	Integral Heat	UDINT	Set the PID integral in minutes per repeat for the heat outputs.	0.00 to 99.99 (* 1000) minutes per repeat. 0.00 = disabled (default = 0.00)
108	Get/Set	Reset Heat	UDINT	Set the PID rate time in minutes for the heat outputs.	0.00 to 99.99 (* 1000) minutes per repeat. 0.00 = disabled (default = 0.00)
109	Get/Set	Derivative Heat	UDINT	Set the PID derivative time in minutes for the heat outputs.	0.00 to 9.99 (* 1000) minutes 0.00 = disabled (default = 0.00)
109	Get/Set	Rate Heat	UDINT	Set the PID rate time in minutes for the heat outputs.	0.00 to 9.99 (* 1000) minutes 0.00 = disabled (default = 0.00)
110	Get/Set	Dead Band Heat	UDINT	An offset of the heating proportional band from the set point.	0 to 999 (default = 0)
111	Get/Set	Heat Hysteresis Temperature	UDINT	Set the control switching hysteresis for ON/OFF control. This determines how far into the ON region the input needs to move before the output actually turns on.	1 to 999 degrees, if Sensor Type is set to Thermocouple or RTD (default = 1.0)
112	Get/Set	Heat Hysteresis Process	UDINT	Set the control switching hysteresis for ON/OFF control. This determines how far into the ON region the input needs to move before the output actually turns on.	0.000 to 999.999 units, if Sensor Type is set to mA or Volt. (default = 1.000)
113	Get/Set	Cool Control Method	USINT	Set the cool control method.	(0) OFF (1) PID (default) (2) ON/OFF

Attribute #	Access Rule	Name	DeviceNet Data Type	Description of Attribute	Semantics of Values
114	Get/Set	Proportional Band Cool Temperature	UDINT	Set the proportional band for the Cool outputs.	1 to 999°C (* 1000), if Sensor Type is set to Thermocouple or RTD. (default = 25°C)
115	Get/Set	Proportional Band Cool Process	UDINT	Set the proportional band for the Cool outputs.	0.001 to 999.999 units, if Sensor Type is set to mA or Volt. (default = 25.000 units)
116	Get/Set	Integral Cool	UDINT	Set the PID integral in minutes per repeat for the Cool outputs.	0.00 to 99.99 (* 1000) minutes per repeat. 0.00 = disabled (default = 0.00)
116	Get/Set	Reset Cool	UDINT	Set the PID reset in repeats per minute for the Cool outputs.	0.00 to 99.99 (* 1000) repeats per minute. 0.00 = disabled (default = 0.00)
117	Get/Set	Derivative Cool	UDINT	Set the PID derivative time in minutes for the Cool outputs.	0.00 to 9.99 (* 1000) minutes 0.00 = disabled (default = 0.00)
117	Get/Set	Rate Cool	UDINT	Set the PID rate time in minutes for the Cool output.	0.00 to 9.99 (* 1000) minutes 0.00 = disabled (default = 0.00)
118	Get/Set	Dead Band Cool	UDINT	An offset of the Cooling proportional band from the set point.	0 to 999 (* 1000) (default = 0)
119	Get/Set	Cool Hysteresis Temperature	UDINT	Set the control switching hysteresis for ON/OFF control. This determines how far into the ON region the input needs to move before the output actually turns on.	1 to 999 (* 1000) degrees, if Sensor Type is set to Thermocouple or RTD (default = 1.0)
120	Get/Set	Cool Hysteresis Process	UDINT	Set the control switching hysteresis for ON/OFF control. This determines how far into the ON region the input needs to move before the output actually turns on.	0.000 to 999.999 units, if Sensor Type is set to mA or Volt. (default = 1.000)
121	Get	Proportional Term	UINT	View the active proportional term for PID diagnostics.	0.000 to 1.000 (this value multiplied by 100 equals the percent power)

Attribute #	Access Rule	Name	DeviceNet Data Type	Description of Attribute	Semantics of Values
122	Get	Integral Term	UINT	View the active integral term for PID diagnostics.	0.000 to 1.000 (this value multiplied by 100 equals the percent power)
123	Get	Derivative Term	UINT	View the active derivative term for PID diagnostics.	0.000 to 1.000 (this value multiplied by 100 equals the percent power)
124	Get/Set	Alarm 1 High Temperature	DINT	Set the high alarm set point.	0 to 9999 (* 1000) if Sensor Type is set to Thermocouple or RTD (default = 999)
125	Get/Set	Alarm 1 High Process	DINT	Set the high alarm set point.	-1999 to 9999 (* 1000) if Sensor Type is set to mA or Volt. (default = 1500)
126	Get/Set	Alarm 1 Low Temperature	DINT	Set the low alarm set point.	-1999 to 0 (* 1000) if Sensor Type is set to Thermocouple or RTD (default = -999)
127	Get/Set	Alarm 1 Low Process	DINT	Set the low alarm set point.	-1999 to 9999 (* 1000) if Sensor Type is set to mA or Volt. (default = 32)
128	Get/Set	Alarm 2 High Temperature	DINT	Set the high alarm set point.	0 to 9999 (* 1000) if Sensor Type is set to Thermocouple or RTD (default = 999)
129	Get/Set	Alarm 2 High Process	DINT	Set the high alarm set point.	-1999 to 9999 (* 1000) if Sensor Type is set to mA or Volt. (default = 1500)

Attribute #	Access Rule	Name	DeviceNet Data Type	Description of Attribute	Semantics of Values
130	Get/Set	Alarm 2 Low Temperature	DINT	Set the low alarm set point.	-1999 to 0 (* 1000) if Sensor Type is set to Thermocouple or RTD (default = -999) -1999 to 9999 (* 1000) if Sensor Type is set to mA or Volt. (default = 32)
131	Get/Set	Alarm 2 Low Process	DINT	Set the low alarm set point.	-1999 to 9999 (* 1000) if Sensor Type is set to mA or Volt. (default = 32)
132	Get/Set	Event Output 1	BOOLEAN	Set event output 1 to an on or off state.	(0) OFF (default) (1) ON
133	Get/Set	Event Output 2	BOOLEAN	Set event output 2 to an on or off state.	(0) OFF (default) (1) ON

Class Services:

- 0x0E GET ATTRIBUTE SINGLE

Instance Services:

- 0x0E GET ATTRIBUTE SINGLE
- 0x10 SET ATTRIBUTE SINGLE

NOTE: All successful Explicit Message Responses from a SET service will contain no data. The response will be a two-byte message containing the requester's MAC ID and Service Code (with R/R bit set).

Factory/Calibration Object

Class Code: 67hex

Factory/Calibration Object

The Factory/Calibration Object provides access to parameters that contain diagnostics information, calibration and restore-parameter functions.

Table 28. Factory/Calibration Revision History

Revision	Description
01	Initial Release

Table 29. Factory/Calibration Class Attributes

Attribute #	Access Rule	Name	DeviceNet Data Type	Description of Attribute	Semantics of Values
1	Get	Revision	UINT	Revision of this object	The revision level of this object (currently 1)
2	Get	Max Instance	UINT	Max allowed Instances of this object	Always 1 for this Class

Table 30. Factory/Calibration Object Instance Attributes

Attribute #	Access Rule	Name	DeviceNet Data Type	Description of Attribute	Semantics of Values
100	Get	Ambient Temperature	DINT	Displays the current calculated ambient temperature.	-50.0 to 300.0°F (* 1000)
101	Get	Output 1 Process Value	UINT	Monitors Process Output 1 value via DeviceNet	00.00 to 22.00 units
102	Get/Set	Restore Factory Calibration	BOOLEAN	Replaces the user calibration parameters with the factory calibration parameters.	(0) NO (default) (1) YES
103	Get/Set	Restore User Settings	BOOLEAN	Restores the customer-configured settings.	(0) NO (default) (1) YES
104	Get/Set	Save User Settings	BOOLEAN	Saves the current customer-configured settings.	(0) NO (default) (1) YES
105	Get/Set	Default Parameters	BOOLEAN	Reset all parameters to their default values.	(0) NO (default) (1) YES
106	Get	Output 1 Type	USINT	Displays the hardware type for Output 1.	(0) None (1) DC/Open Col. (2) Mech. Relay (3) S.S. Relay (4) Process
107	Get	Output 2 Type	USINT	Displays the hardware type for Output 2.	(0) None (1) DC/Open Col. (2) Mech. Relay (3) S.S. Relay (4) Process
108	Get	Software ID	UINT	Software ID number	0 to 9999
109	Get	Software Build Number	UINT	Software built number	0 to 9999 Build Number
110	Get	Serial Number	UDINT	Serial number	0 to 99999999

Attribute #	Access Rule	Name	DeviceNet Data Type	Description of Attribute	Semantics of Values
134	Get/Set	Non volatile Write	BOOLEAN	Write to non volatile memory	(0) No (1) Yes (default)
134	Get	Constant	UINT	Date Code	
135	Get	Output 2 Process Value	UINT	Monitors Process Output 2 value via DeviceNet	00.00 to 22.00 units
136	Get/Set	Restore User Profile Settings	BOOLEAN	Restores the customer-configured settings.	(0) NO (default) (1) YES
137	Get/Set	Save User Profile Settings	BOOLEAN	Saves the current customer-configured settings.	(0) NO (default) (1) YES

Class Services:

- 0x0E GET ATTRIBUTE SINGLE

Instance Services:

- 0x0E GET ATTRIBUTE SINGLE
- 0x10 SET ATTRIBUTE SINGLE

NOTE: All successful Explicit Message Responses from a SET service will contain no data. The response will be a two-byte message containing the requester's MAC ID and Service Code (with R/R bit set).

Programmable Object

Class Code: 68hex

Programmable Object

The Programmable Object determines what parameters appear on the Operations Page.

Table 31. Programmable Object Revision History

Revision	Description
01	Initial Release

Table 32. Programmable Class Attributes

Attribute #	Access Rule	Name	DeviceNet Data Type	Description of Attribute	Semantics of Values
1	Get	Revision	UINT	Revision of this object	The revision level of this object (currently 1)
2	Get	Max Instance	UINT	Max allowed Instances of this object	Always 1 for this Class

Table 33. Programmable Object Instance Attributes

Attribute #	Access Rule	Name	DeviceNet Data Type	Description of Attribute	Semantics of Values
100	Get/set	P1	USINT	Programmable Parameter Location 1	See Programming Page in user's manual.
101	Get/set	P2	USINT	Programmable Parameter Location 2	See Programming Page in user's manual.
102	Get/Set	P3	USINT	Programmable Parameter Location 3	See Programming Page in user's manual.
103	Get/Set	P4	USINT	Programmable Parameter Location 4	See Programming Page in user's manual.
104	Get/Set	P5	USINT	Programmable Parameter Location 5	See Programming Page in user's manual.
105	Get/Set	P6	USINT	Programmable Parameter Location 6	See Programming Page in user's manual.
106	Get/set	P7	USINT	Programmable Parameter Location 7	See Programming Page in user's manual.
107	Get/set	P8	USINT	Programmable Parameter Location 8	See Programming Page in user's manual.
108	Get/set	P9	USINT	Programmable Parameter Location 9	See Programming Page in user's manual.
109	Get/set	P10	USINT	Programmable Parameter Location 10	See Programming Page in user's manual.
110	Get/set	P11	USINT	Programmable Parameter Location 11	See Programming Page in user's manual.
111	Get/set	P12	USINT	Programmable Parameter Location 12	See Programming Page in user's manual.
112	Get/set	P13	USINT	Programmable Parameter Location 13	See Programming Page in user's manual.
113	Get/set	P14	USINT	Programmable Parameter Location 14	See Programming Page in user's manual.
114	Get/set	P15	USINT	Programmable Parameter Location 15	See Programming Page in user's manual.

Attribute #	Access Rule	Name	DeviceNet Data Type	Description of Attribute	Semantics of Values
115	Get/set	P16	USINT	Programmable Parameter Location 16	See Programming Page in user's manual.
116	Get/set	P17	USINT	Programmable Parameter Location 17	See Programming Page in user's manual.
117	Get/set	P18	USINT	Programmable Parameter Location 18	See Programming Page in user's manual.
118	Get/set	P19	USINT	Programmable Parameter Location 19	See Programming Page in user's manual.
119	Get/set	P20	USINT	Programmable Parameter Location 20	See Programming Page in user's manual.
120	Get/set	P21	USINT	Programmable Parameter Location 21	See Programming Page in user's manual.
121	Get/set	P22	USINT	Programmable Parameter Location 22	See Programming Page in user's manual.
122	Get/set	P23	USINT	Programmable Parameter Location 23	See Programming Page in user's manual.

Class Services:

- 0x0E GET ATTRIBUTE SINGLE

Instance Services:

- 0x0E GET ATTRIBUTE SINGLE
- 0x10 SET ATTRIBUTE SINGLE

NOTE: All successful Explicit Message Responses from a SET service will contain no data. The response will be a two-byte message containing the requester's MAC ID and Service Code (with R/R bit set).

Profiling Object

Class Code: 69hex

Profiling Object

The Profiling Object provides access to parameters that contain profiling parameters.

Table 34. Profiling Object Revision History

Revision	Description
01	Initial Release

Table 35. Profiling Class Attributes

Attribute #	Access Rule	Name	DeviceNet Data Type	Description of Attribute	Semantics of Values
1	Get	Revision	UINT	Revision of this object	The revision level of this object (currently 1)
2	Get	Max Instance	UINT	Max allowed Instances of this object	Always 1 for this Class

Table 36. Profiling Object Instance Attributes

Attribute #	Access Rule	Name	DeviceNet Data Type	Description of Attribute	Semantics of Values
100	Get/Set	Profile Type	BOOLEAN	Set the profile ramp to time based or rate based	(0) - Time (default) (1) - Rate
101	Get/Set	Profile Start	BOOLEAN	Selects where the profile begins the starting set point of the profile, current static set point or current process temperature.	(0) - Set Point (default) (1) - Process
102	Get/Set	Guaranteed Soak Deviation Enable	BOOLEAN	Enables the guaranteed soak deviation function in profiles	(0) - Disabled (default) (1) - Enabled
103	Get/Set	Guaranteed Soak Deviation Value	UDINT	Set the value of deviation allowed by the guaranteed soak deviation function	1 to 999 (*1000) (default = 1)
104	Get	Profile State	USINT	Indicates current profile status	(0) - Off (default) (1) - Holding (2) - Running (3) - Pre-run check failed when starting the profile (4) - Pre-run failed when resuming the profile
105	Get	Jump Count Step Enabled	BOOLEAN	Indicates whether a Jump Step is currently being executed	(0) - Profile is not running or is running and currently not executing a Jump step (default) (1) - Profile is executing a Jump step
106	Get/Set	Start File Number	UINT	Selects the file to start running	1 to 4 (default = 1)
107	Get/Set	Start Step Number	UINT	Selects the profile step to be run	1 to 10 (default = 1)
108	Get/Set	Profile Select	USINT	Selects what to do when a profile is on hold	(0) - Off (1) - Resume (2) - Hold
109	Get	Guaranteed Soak Deviation Message	BOOLEAN	Monitors guaranteed soak deviation status	(0)- Disabled (default) (1)- Enabled
110	Get	File Running	UINT	File number that is currently running	1 to 4
111	Get	Step Running	UINT	Step number that is currently running	1 to 10
112	Get	End Set Point Value	DINT	Set point value reached at the end of current step	(Splo) to (sphi)

Attribute #	Access Rule	Name	DeviceNet Data Type	Description of Attribute	Semantics of Values
113	Get	Hours Remaining	UINT	Indicates number of hours remaining in the step currently running	0 to 99
114	Get	Minutes Remaining	UINT	Indicates number of minutes remaining in the step currently running	0 to 59
115	Get	Seconds Remaining	UINT	Indicates number of seconds remaining in the step currently running	0 to 59
116	Get	Ramp Rate	UDINT	Rate at which the profile changes in degrees or units per minute	0.0 to 9999.9 (*1000)
117	Get	Event Output 1 status	BOOLEAN	Indicates Event Output 1 status	(0)- OFF (1)- ON
118	Get	Event Output 2 status	BOOLEAN	Indicates Event Output 2 status	(0)- OFF (1)- ON
119	Get	Wait-for Process Value	DINT	Profile clock waits until the process value matches the Wait-for value and continues with the step	(Splo) to (sphi)
120	Get	Elapsed Jump Count	UDINT	Number of times the profile has been through the Jump Loop Step	0 to 9999 (*1000)
121	Get	Failed File Number	UINT	Indicates the file number that failed the Pre-Run check	1 to 4
122	Get	Failed Step Number	UINT	Indicates the step number that failed the Pre-Run check	1 to 10
123	Get/Set	Comms Temperature Units	BOOLEAN	This register determines the units of measure for temperature values during DeviceNet communication	(0)- Fahrenheit (default) (1)- Celsius

Class Services:

- 0x0E GET ATTRIBUTE SINGLE

Instance Services:

- 0x0E GET ATTRIBUTE SINGLE
- 0x10 SET ATTRIBUTE SINGLE

NOTE: All successful Explicit Message Responses from a SET service will contain no data. The response will be a two-byte message containing the requester's MAC ID and Service Code (with R/R bit set).

Profile Program Object

Class Code: 6Ahex

Profile Program Object

The Profile Program Object provides access to parameters that contain profile programs.

Table 37. Profile Program Object Revision History

Revision	Description
01	Initial Release

Table 38. Profile Program Class Attributes

Attribute #	Access Rule	Name	DeviceNet Data Type	Description of Attribute	Semantics of Values
1	Get	Revision	UINT	Revision of this object	The revision level of this object (currently 1)
2	Get	Max Instance	UINT	Max allowed Instances of this object	Always 1 for this Class

Instances 1 through 10 are for File 1, steps 1 through 10.

Instances 11 through 20 are for File 2, steps 1 through 10.

Instances 21 through 30 are for File 3, steps 1 through 10.

Instances 31 through 40 are for File 4, steps 1 through 10.

Table 39. Profiling Object Instance Attributes

Attribute #	Access Rule	Name	DeviceNet Data Type	Description of Attribute	Semantics of Values
100	Get/Set	Step Type	USINT	Selects step type	(0) - End (default) (1) - Set Point (2) - Soak (3) - Jump Loop (4) - Link File
101	Get/Set	Target Set Point	DINT	Indicates ending set point value	-1999 to 9999 (*1000) (default = 75)
102	Get/Set	Hours	UINT	Hours in the step	0 to 99. (default = 0)
103	Get/Set	Minutes	UINT	Minutes in the step	0 to 59. (default = 0)
104	Get/Set	Seconds	UINT	Seconds in the step	0 to 59. (default = 0)
105	Get/Set	Rate	UDINT	Indicates rate at which set point changes in degrees per minute	0 to 9999 (*1000) (default = 0)
106	Get/Set	Event Output 1	BOOLEAN	Selects whether output 1 is on or off during step	(0) - OFF (default) (1) - ON

Attribute #	Access Rule	Name	DeviceNet Data Type	Description of Attribute	Semantics of Values
107	Get/Set	Event Output 2	BOOLEAN	Selects whether output 2 is on or off during step	(0) - OFF (default) (1) - ON
108	Get/Set	Wait-for Process Enable	BOOLEAN	Select to enable Wait-for Process value	(0) - NO (default) (1) - YES
109	Get/Set	Wait-for Process value	DINT	Selects wait-for value before step timer starts	-1999 to 9999(*1000) Default = 75
110	Get/Set	Jump File	UINT	Selects the file which is to be jumped to	1 to 4. Default = 1
111	Get/Set	Jump Step	UINT	Selects the step which is to be jumped to	1 to 10. Default = 1
112	Get/Set	Jump Count	UINT	Indicates the number of time the jump is to be done.	0 to 9999. Default = 1
113	Get/Set	Link File	UINT	Selects the file to link to.	1 to 4. Default = 1
114	Get/Set	End	BOOLEAN	Selects the state of the control and auxiliary outputs when a profile is ended	(0) - Off (default) (1) - Hold

Class Services:

- 0x0E GET ATTRIBUTE SINGLE

Instance Services:

- 0x0E GET ATTRIBUTE SINGLE
- 0x10 SET ATTRIBUTE SINGLE

NOTE: All successful Explicit Message Responses from a SET service will contain no data. The response will be a two-byte message containing the requester's MAC ID and Service Code (with R/R bit set).