

MLS

User's Guide

Watlow Controls

1241 Bundy Blvd.
Winona, MN 55987

Customer Service

Phone: (800) 414-4299
Fax: (800) 445-8992

Technical Support

Phone: (507) 494-5656
Fax: (507) 452-4507
Email: wintechsupport@watlow.com

Part No. 11570-00. Revision 3.7
November 1995

Copyright © 1995
Watlow-Anafaze

Information in this manual is subject to change without notice. No part of this publication may be reproduced, stored in a retrieval system, or transmitted in any form without written permission from Watlow-Anafaze.

Warranty

Watlow-Anafaze, Incorporated warrants that the products furnished under this Agreement will be free from defects in material and workmanship for a period of one year from the date of shipment. The customer shall provide notice of any defect to Watlow-Anafaze, Incorporated within one week after the Customer's discovery of such defect. The sole obligation and liability of Watlow-Anafaze, Incorporated under this warranty shall be to repair or replace, at its option and without cost to the Customer, the defective product or part.

Upon request by Watlow-Anafaze, Incorporated, the product or part claimed to be defective shall immediately be returned at the Customer's expense to Watlow-Anafaze, Incorporated. Replaced or repaired products or parts will be shipped to the Customer at the expense of Watlow-Anafaze, Incorporated.

There shall be no warranty or liability for any products or parts that have been subject to misuse, accident, negligence, failure of electric power or modification by the Customer without the written approval of Watlow-Anafaze, Incorporated. Final determination of warranty eligibility shall be made by Watlow-Anafaze, Incorporated. If a warranty claim is considered invalid for any reason, the Customer will be charged for services performed and expenses incurred by Watlow-Anafaze, Incorporated in handling and shipping the returned unit.

If replacement parts are supplied or repairs made during the original warranty period, the warranty period for the replacement or repaired part shall terminate with the termination of the warranty period of the original product or part.

The foregoing warranty constitutes the sole liability of Watlow-Anafaze, Incorporated and the customer's sole remedy with respect to the products. It is in lieu of all other warranties, liabilities, and remedies. Except as thus provided, Watlow-Anafaze, Inc. disclaims all warranties, express or implied, including any warranty of merchantability or fitness for a particular purpose.

Please Note: External safety devices must be used with this equipment.

Addendum for MLS User's Guide (3.6)

The following are changes to revision 3.6 of the MLS User's Guide. The changes pertain to a new power supply that is being used with the MLS. All changes are listed below by page number. Shaded portions refer to the actual changed text.

These changes will be incorporated in the next manual revision.

System Power Requirements (from page 10)

MLS-PM supply input	10-28 Vdc at <1 amp
MLS-AIM supply input	4.75 to 5.25 Vdc at <0.5 amp, supplied by MLS-PM
MLS-PS system power supply	Input: 120/240 Vac at 0.75 amp Output: 15 Vdc at 1.2 amp, 5 Vdc at 4 amp

Dimensions and Weight (from page 10)

MLS-PM	1.75 lbs., 1.89" x 3.78" x 6.75" (0.8 kg, 4.75 cm x 10 cm x 17 cm.)
MLS-AIM-TB & AIM cards	1.50 lbs., 5.0" x 6.50" x 5.50" (0.7 kg, 12.5 cm x 16.25 cm x 13.75 cm.)
MLS-PS	1.2 lbs., 1.40" x 8.0" x 3.9" (0.6 kg, 3.56 cm x 20.32 cm x 9.91 cm.)
RTB	.5 lbs, 5.0" x 3.0" x 2.25" (.227 kg, 12.7 cm x 7.6 cm x 5.7 cm.)

Mounting the MLS-PS (from page 23)

Follow these instructions to mount the MLS-PS.

If you use your own power supply for the MLS, please refer to the power supply manufacturer's instructions for mounting information. Choose a power supply that supplies a regulated 10 to 28 Vdc at 1 watt, and isolated return line.

Mounting Environment

The MLS-PS measures 1.40" x 8" x 3.9". Leave enough clearance around the power supply that you can remove it later.

Mounting Steps

The MLS-PS has a mounting bracket. The bracket has two screw holes which will accept #6 or #10 screws. To mount the MLS-PS, attach the power supply to your panel with the two screws and the power supply mounting bracket.

Wiring Your System (from page 24)

This section explains how to wire the components of your system.

Below is the system connections diagram reprinted here for your convenience. (See the next page for wiring instructions.)

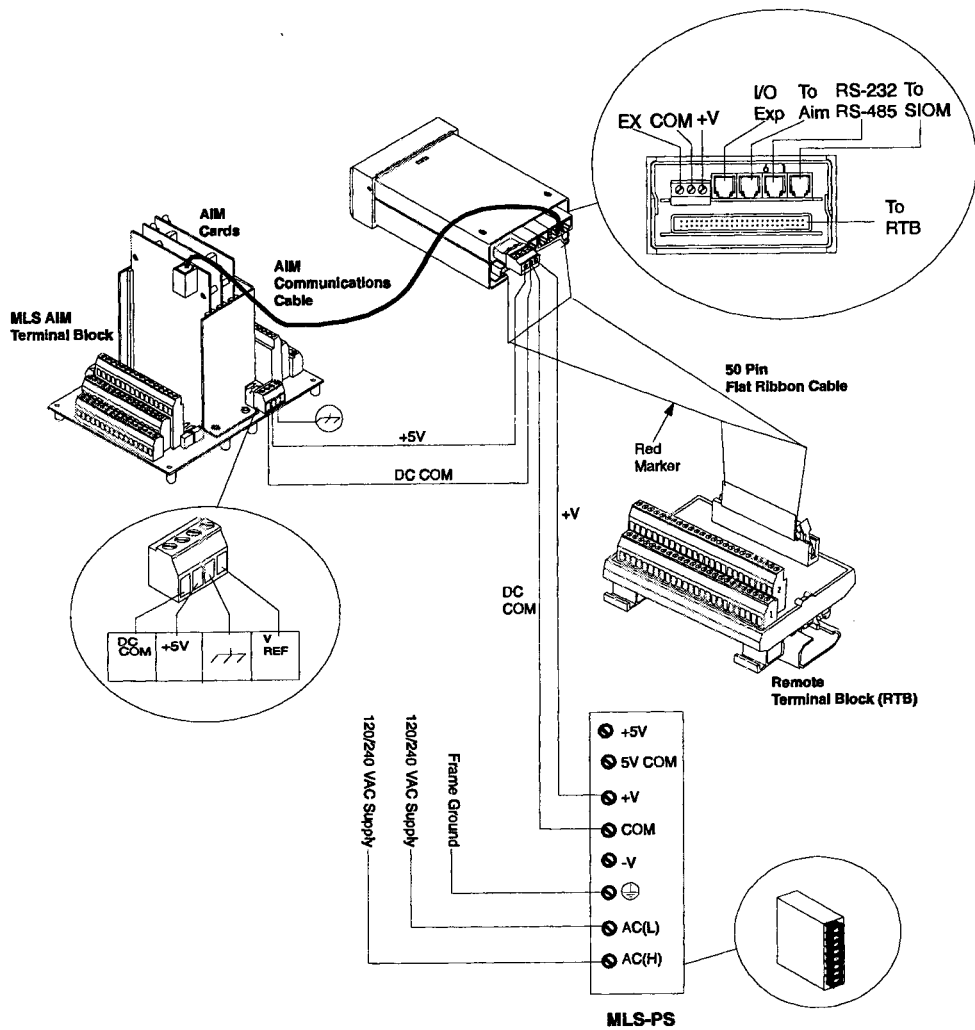

Wiring Recommendations (from page 25)

This section gives general wiring recommendations.



WARNING

Never wire bundles of low power Watlow-Anafaze circuits next to bundles of high power AC wiring. Instead, physically separate high power circuits from the controller. If possible, install high voltage

AC power circuits in a separate panel.

- Use stranded wire. (Use solid wire for fixed service; it makes intermittent connections when you move it for maintenance.)
- Use #18 or #20 AWG wire. Larger or smaller sizes may be difficult to install, may break easily, or may cause intermittent connections.
- Use shielded wire. (The electrical shield protects the MLS from electrical noise.) Connect one end of the **input wiring shield** to the MLS panel's 120/240 Vac panel ground, and connect one end of the **output wiring shield** to the MLS panel's 120/240 Vac panel ground. (If your system requires a different shield configuration, contact Watlow-Anafaze for more information.)

For more information about noise suppression, see **Noise Suppression**.

Connecting Power and RTB to MLS-PM (from page 27)

1. Remove the temporary covers you placed on the MLS' housing.
2. Connect the power supply terminal labeled "DC COM" to the terminal labeled "GND" on the Processor Module. This terminal is DC common; it is not frame, chassis or earth ground.
3. Connect the power supply terminal labeled "+15V" to the terminal labeled "+V" on the Processor Module.
4. Connect the 50-pin ribbon cable to the Processor Module. Plug it in so that the red stripe is on the left side, under TB1.
5. Connect the ribbon cable to the RTB. Plug it in so that the red stripe is closest to screw terminal 1.

Contents

Overview	1
System Diagram.....	2
Parts List	2
Safety	3
Introduction.....	5
Specifications.....	7
Analog Outputs	8
Digital Inputs	8
Digital Outputs.....	9
Miscellaneous Specifications.....	10
Serial Interface	10
System Power Requirements	10
Environmental Specifications	10
Dimensions and Weight.....	10
Expanded Parts List	11
MLS Processor Module Technical Description.....	11
MLS RTB Technical Description	13
MLS-AIM and AIM-TB Technical Description.....	13
MLS Cabling Technical Description	14
Installation.....	15
Read This Before Installation	16
Recommended Tools	17
Panel Hole Cutters	17
Other Tools	17
Additional Hardware.....	17
Mounting the MLS-PM	18
Mounting Environment.....	18
MLS-PM Mounting Steps.....	19
Mounting the MLS-AIM	20
Mounting Environment.....	20
Mounting Steps	21
Mounting the RTB	22
Mounting the MLS-PS.....	23
Mounting Environment.....	23
Mounting Steps	23
Wiring Your System	24
Wiring Recommendations	25
Cable Recommendations	26
Noise Suppression.....	26
Wiring and Testing Your System	27

Connecting Power and RTB to MLS-PM.....	27
Connecting Power and Common to AIM-TB.....	28
Testing Connections	28
Testing Your System	30
MLS-AIM Test	30
RTB Test.....	30
PID Output Test.....	30
Outputs.....	31
PID Control and Alarm Output Connections.....	33
RTB Connections.....	34
AIM Communications Failure	35
Inputs	36
Input Wiring Recommendations	37
Input Scaling	37
T/C Inputs	39
RTD Inputs	40
Current Inputs	41
Voltage Inputs.....	41
Unused Inputs	41
Communications	42
Changing Communications.....	42
Connecting RS-232 Communications	42
Connecting RS-485 Communications	43
Recommended Wire Gauges	45
Using the MLS.....	47
Front Panel.....	48
Front Panel Keys.....	49
Displays	51
Viewing Several Loops: Bar Graph Display	51
Viewing One Loop: Single Loop Display	52
Interpreting Alarm Display	53
Displaying, Loading, and Saving Jobs.....	55
Operator Menus	56
Changing the Setpoint.....	56
Selecting Manual, Automatic, or Tune Control.....	56
Setup	59
How to enter the Setup menus?	59
How to edit a menu?	59
Setup Global Parameters Menu	61
Save to Job	62
Load from Job.....	62
Job Select Inputs	63

Job Digital Input Polarity.....	64
Output Override Digital Input.....	64
Output Override Input Polarity.....	64
Startup Alarm Delay.....	65
Keyboard Lock Status.....	65
Power-Up Output Status.....	65
Controller Address.....	66
Communications Error Checking.....	66
Communications Baud Rate.....	67
Allen Bradley Protocol.....	67
AC Line Frequency.....	67
Digital Output Polarity.....	68
AIM Communications Failure Output.....	68
EPROM Information.....	68
Setup Loop Input.....	69
Input Type.....	70
Pulse Sample Time.....	71
Loop Name.....	71
Input Units.....	71
Input Reading Offset.....	72
Linear Scaling Menus.....	72
Display Format.....	74
High Process Value.....	74
High Reading.....	75
Low Process Value.....	75
Low Reading.....	75
Input Filter.....	76
Setup Loop Control Parameters.....	77
Heat/Cool Control PB.....	78
Heat/Cool Control TI.....	78
Heat/Cool Control TD.....	78
Heat/Cool Output Filter.....	79
Heat/Cool Spread.....	79
Setup Loop Outputs.....	80
Enable/Disable Heat and Cool Outputs.....	82
Heat or Cool Output Type.....	82
Heat/Cool Cycle Time.....	83
SDAC Menus.....	83
SDAC Mode.....	83
SDAC High Value.....	84
SDAC Low Value.....	84
Heat/Cool Output Action.....	84
Heat/Cool Output Limit.....	85
Heat/Cool Output Limit Time.....	85

Heat/Cool Output Override.....	85
Heat/Cool Nonlinear Output Curve	86
Setup Loop Alarms	87
Alarm Types	88
Alarm Delay.....	90
High Process Alarm Setpoint.....	91
High Process Alarm Type.....	91
High Process Alarm Output Number.....	91
Deviation Band Value.....	92
High Deviation Alarm Type	92
High Deviation Alarm Output Number	93
Low Deviation Alarm Type.....	93
Low Deviation Alarm Output Number.....	93
Low Process Alarm Setpoint	94
Low Process Alarm Type	94
Low Process Alarm Output Number	94
Alarm Deadband.....	95
Loop Alarm Delay	95
Manual I/O Test	96
Digital Input Testing.....	97
Keypad Test	97
Test Digital Output	97
Toggle Digital Output.....	98
Tuning and Control.....	99
Introduction.....	99
Control Modes	99
On/Off Control.....	99
Proportional Control	100
Proportional and Integral Control	101
Proportional, Integral and Derivative Control	101
Digital Output Control Forms.....	102
Setting Up and Tuning PID Loops	104
Proportional Band (PB) Settings.....	104
Integral Term (TI) Settings	105
Derivative Term (TD) Settings	105
General PID Constants.....	106
Proportional Band Only (P)	106
Proportional with Integral (PI).....	106
PI with Derivative (PID).....	106
Troubleshooting.....	109
Manual Controller Reset.....	109
Returning your Unit to ANAFAZE	110

Troubleshooting Stand-Alone Systems 110

 MLS-PM Has No Power..... 110

 Keys Don't Respond..... 111

 Controller Message: AIM Comm Failure 111

 Checking Analog Inputs 111

 Checking PID Control Outputs..... 112

 Checking Digital I/O..... 112

Checking Computer Supervised Systems 113

 Computer Problems 113

 Serial Interface Problems..... 113

 Communications Problems 114

 Software Problems..... 115

 Changing the EPROM 116

Linear Scaling Examples 119

 Example 1: Configuring a Pressure Sensor 119

 Example 2: Configuring a Flow Sensor..... 120

Glossary 121

Overview

This manual describes how to install, setup, and operate a 16 or 32 MLS controller. Included are seven chapters and a glossary of terms. Each chapter covers a different aspect of your control system and may apply to different users. The following describes the chapters and their purpose.

- **Introduction:** Gives a general description of the MLS and its related specifications.
- **Installation:** Describes how to install the MLS and its peripheral devices.
- **Using the MLS:** Provides an overview of operator displays used for system monitoring.
- **Setup:** Describes all the setup displays for the controller, and how to access them.
- **Tuning and Control:** Explains PID control and provides tips for tuning your system.
- **Troubleshooting:** Gives some basic guidelines for solving control problems.
- **Linear Scaling Examples:** Provides an example configuring a pressure sensor, and one configuring a flow sensor.

System Diagram

The illustration below shows how the parts of the MLS are connected. When unpacking your system, use the diagram and parts list below to ensure all parts have been shipped. Please don't hesitate to call Watlow-Anafaze's Technical Service Department if you have problems with your shipment, or if the MLS' components are missing or damaged.

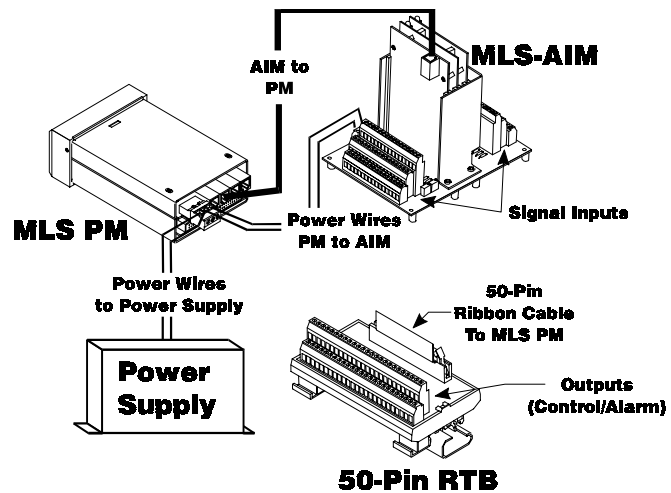

Parts List

- MLS Processor Module (PM)
- Controller Mounting Kit
- MLS AIM Module (16 or 32)
- AIM Cable, 4 foot.
- RS-232 or RS-485 Com Cable (optional)
- RTB Terminal Block
- 50-Pin Ribbon Cable
- Power Supply (optional)

Safety

Watlow-Anafaze has made efforts to ensure the reliability and safety of the MLS™ Controller and to recommend safe usage practices in systems applications. Please note that, in any application, failures can occur. These failures may result in full control outputs or other outputs which may cause damage to or unsafe conditions in the equipment or process connected to the MLS Controller.

Good engineering practices, electrical codes, and insurance regulations require that you use independent external safety devices to prevent potentially dangerous or unsafe conditions. Assume that the Watlow-Anafaze MLS Controller can fail with outputs full on, outputs full off, or that other unexpected conditions can occur.

Install high or low temperature protection in systems where an overtemperature or undertemperature fault condition could present a fire hazard or other hazard. Failure to install temperature control protection where a potential hazard exists could result in damage to equipment and property, and injury to personnel.

The MLS includes a reset circuit that sets the control outputs off or to the data stored in memory if the microprocessor resets--normally the result of a power failure and power return. If a memory-based restart will be unsafe for your process, program the MLS Controller to restart with outputs off. For additional safety, program the computer or other host device to automatically reload the desired operating constants or process values on return of operating power. However, these safety features do not eliminate the need for external, independent safety devices in potentially dangerous or unsafe conditions.

Watlow-Anafaze also offers ANASOFT®, an optional software program for IBM-AT® or IBM-PC® compatible computers. In the event of a reset, ANASOFT will reload the MLS Controller with the current values in computer memory. The user must ensure that this reset will be safe for the process. Again, use of ANASOFT does not eliminate the need for appropriate external, independent safety devices.

Contact Watlow-Anafaze immediately if you have any questions about system safety or system operation.

Introduction

The MLS is a modular control system with 32 fully independent loops of PID control. It can function as a stand-alone controller; the MLS processor module's 1/8 DIN front panel has a Liquid Crystal Display (LCD) and touch keypad for local display and local parameter entry. You can also use it as the key element in a computer-supervised data acquisition and control system; the MLS can be locally or remotely controlled via an RS-232 or RS-485 serial communications interface.

The MLS features include:

Direct Connection of Mixed Thermocouple Sensors: Versatile analog inputs let you directly connect most thermocouples. Thermocouple inputs feature reference junction compensation, linearization, PV offset calibration to correct for sensor inaccuracies, T/C upscale break detection, and your choice of Fahrenheit or Celsius display.

Resistive Temperature Detector Sensors are Standard Inputs: The standard three-wire 100 W platinum DIN curve sensor is a standard input for the MLS, as well as the Nickel RTD.

Automatic Scaling of Linear Analog Inputs: The MLS automatically scales linear inputs used with other industrial process sensors. To scale inputs, simply enter any two measurement points. For example, to scale a pH sensor enter the endpoints: the low PV is 2.0 pH, while the high PV is 14.0 pH. All subsequent values will be in pH.

Independently Selectable PID Output Modes: You can set each loop's digital output to ON/OFF, Time Proportioning, Serial DAC, or Distributed Zero Crossing mode. You can set each loop control mode for ON/OFF, P, PI, or PID control with reverse or direct action output.

Flexible Alarm Outputs: You can set independent high/low process alarms and a high/low deviation band alarm for each loop. Each alarm can activate an individual digital output or it can be grouped with other alarms to activate a single digital output.

Alarm or Control Outputs: You can set high/low deviation and high/low process setpoints to operate separate digital outputs as on/off control functions instead of as alarms. (The control function will not have alarm notification or global alarm output.)

Global Alarm Output: When any alarm is triggered, the Global Alarm Output is also triggered, and it stays on until you acknowledge it.

Watchdog Timer: The MLS watchdog timer (System Safe) output provides a digital output which notifies you if the system fails.

Front Panel or Computer Operation: You can set up and run the MLS Controller from the processor module's front panel or from a local or remote computer. Watlow-Anafaze offers ANASOFT, our IBM-AT or IBM-PC compatible software you can use to operate the MLS. ANASOFT has these features:

- Graphic Trend Plotting
- Process Overviews
- Printouts
- Data Archiving in Lotus-Compatible Files

Multiple Job Storage: You can store up to 8 jobs in protected memory and access them by entering a single job number. Each job is a set of operating conditions, including setpoints and alarms--so if a single oven produces multiple products, simply enter one job number to set up every loop.

Dual Outputs Standard for 16 Loops: The 16-loop MLS Controller includes dual control outputs for each loop, and a second set of control constants for heating and cooling applications.

Flexible Outputs Standard for 32 Loops: The 32-loop MLS Controller is factory set for a single heat output for each input. Outputs for loops 17-32 can be assigned as second outputs for loops 1-16.

Specifications

This section shows specifications for the MLS, including inputs, outputs, serial interface information, system power requirements, and environmental and physical specifications.

Analog Inputs

Number of control loops	16 dual output or 32 single output plus one pulse loop.
Number of analog inputs	16 (with AIM-16) or 32 (with AIM-32).
Input switching	Differential solid state MUX switching.
Input sampling rate	16 loops per second.
Analog over-voltage protection between inputs	70 V peak to peak maximum.
Maximum analog input voltage	+10 V from + or - input to analog common.
Common mode voltage	500 Vac maximum analog common to MLS-PM or MLS-AIM power supply common.
CMR (Common Mode Rejection)	>85 dB at 60 Hz, 110 dB typical.
A/D converter	Integrates voltage to frequency.
Integration time per loop	33.3 ms at 60 Hz line frequency.
Input range	-10 to +60 mV, or 0 to 25 V with scaling resistors.
Resolution	0.02%, greater than 12 bits (internal)
Accuracy	0.1% at 25°C
Calibration	Automatic zero and full scale.
Temperature coefficient	Less than 100 ppm/°C, 0.01% per °C.
Analog Ground to frame Ground Max. potential	40 V
DC Common to frame Ground Max. potential	40 V

Thermocouple Ranges

J	-350 to 1400°F (-212 to 760°C)
K	-450 to 2500°F (-268 to 1371°C)
T	-450 to 750°F (-268 to 399°C)
B	150 to 3200°F (+66 to 1760°C)
S	0 to 3200°F (-18 to 1760°C)
R	0 to 3210°F (-18 to 1766°C)

RTD Ranges

RTD1	-148.0 to 572°F (-100.0 to 300.0°C)	0.1°C
RTD2	-184 to 1544°F (-120 to 840°C)	1.0°C
RTD3	-94 to 572°F (-70 to 300°C)	1.0°C

Miscellaneous Specifications

T/C break detection	Pulse type for upscale break detection and thermocouple alarm display.
Milliamp inputs	0-10 mA, 0-20 mA (4-20 mA), etc., with scaling resistors.
Infrared inputs	power supply included, with scaling resistors for IRSM.
Source impedance	Measurements are within specification with up to 500 ohms source resistance.

Analog Outputs

The Watlow-Anafaze Digital to Analog Converter (DAC) is an optional module for MLS and CLS controllers. It lets you convert a distributed zero crossing output signal to an analog process control signal. You can purchase 4-20 mAdc, 0-5 Vdc, and 0-10 Vdc versions of the DAC.

Watlow-Anafaze also offers the Serial DAC for precision open-loop control. 0-5 Vdc / 4-20 mAdc jumper selectable. Contact Watlow-Anafaze for more information about the DAC and Serial DAC.

Digital Inputs

Number	8
Input voltage protection	Diodes to supply and common
Absolute maximum input current	±10 mA
Voltage levels	<1.3V=Low; >3.7V=High
Maximum input current	1.2 mA from MLS with input at zero volts
Maximum switch resistance to pull input low	1 Kohm
Minimum switch off resistance	11 Kohm

Digital Outputs

Standard Digital Outputs

Number	34 continuous 10 mA sink referenced to +5 Vdc of MLS for SSR operation; 20 mA momentary peak sink.
User selectable outputs	34 PID control, Alarm/control, or Events. Two outputs are not PID programmable.
Number of PID loops	16 or 32 programmable loops. 16-loop systems have dual outputs. 32-loop systems have 32 single outputs, and you can individually configure outputs 17-32 as a second outputs for loops 1-16.
PID control outputs	Time Proportioning, Distributed Zero Crossing, or On/Off--all independently selectable for each loop.
Cycle Time	1-255 seconds.
Control Action	Reverse (heat) or Direct (cool), independently selectable for each loop.
Off State Leakage Current	<.01 mA to DC common.

System Digital Outputs

Number of system digital outputs	2
Configuration	1 global alarm, 5 Vdc at 10 mA sink; 1 System Safe (CPU Watchdog Timer), 5 Vdc at 10 mA sink.

Miscellaneous Specifications

Serial Interface

Type	RS-232 3-wire or RS-485 4-wire.
Isolation	RS-232: None RS-485: To EIA RS-485 specification.
Baud Rate	2400 or 9600, user selectable.
Error Check	BCC or CRC, user selectable.
Number of Controllers	1 with RS-232 communications, 32 with RS-485 communications, 16 with open frame units.
Protocol	Form of ANSI X3.28-1976, (D1, F1) compatible with Allen-Bradley PLC, full duplex.

System Power Requirements

MLS-PM supply input	10-28 Vdc at <1 amp
MLS-AIM supply input	4.75 to 5.25 Vdc at <0.5 amp, supplied by MLS-PM
MLS-PS system power supply	Input: 120 Vac at 0.5 amp Output: 12 Vdc at 1 amp

Environmental Specifications

Storage Temperature	-20 to 70°C
Operating Temperature	0 to 50°C
Humidity Conditions	10 to 95% non-condensing

Dimensions and Weight

MLS-PM	1.75 lbs., 1.89" x 3.78" x 6.75" (0.8 kg, 4.75 cm x 10 cm x 17 cm.)
MLS-AIM-TB & AIM cards	1.50 lbs., 5.0" x 6.50" x 5.50" (0.7 kg, 12.5 cm x 16.25 cm x 13.75 cm.)
MLS-PS	1.50 lbs., 1.90" x 8.10" x 4.90" (0.7 kg, 4.75 cm x 20.25 cm x 12.25 cm.)
RTB	.5 lbs, 5.0" x 3.0" x 2.25" (.227 kg, 12.7 cm x 7.6 cm x 5.7 cm.)

Expanded Parts List

The Expanded Parts List contains a technical description of each component of your MLS Controller.

MLS Processor Module Technical Description

The MLS Processor Module (MLS-PM) is housed in an eighth-DIN panel mount package. It contains the power supply circuits, the CPU, RAM with a built-in lithium battery socket, EPROM, serial communications, digital I/O, and the LCD screen and touch keypad.

Here's a side view of the MLS-PM:



- Screw terminals connect the power inputs and outputs.
- Input power is 10-28 Vdc at 1 amp.
- The +5 Vdc, 750 mAdc output power supply powers the MLS-AIM.
- A 50-pin flat ribbon cable connects the digital inputs and outputs to the 50-pin terminal block (TB-50).
- The MLS uses 6-pin telephone-style connectors for internal and external communications.

The firmware's operating intelligence resides in the plug-in EPROM, so it's easy to update or change the MLS' firmware. The MLS stores its operating parameters in battery-backed RAM, so if there's a power loss the operating parameters are unchanged. The battery has a ten year shelf life, and it is not used when the unit is on.

The CPU microprocessor performs all calculations for input signal linearization, PID control, alarms, and communications.

The telephone connectors on the rear of the MLS-PM are used for:

- Communications to the MLS-AIM.
- RS-232 or RS-485 communications to an optional computer.
- For OEM customers, communications to the optional MLS Smart I/O Module (MLS-SIOM).

The System safe output is Low (On) when the CPU is running; it keeps a solid state relay closed. If the CPU stops working, the output goes High (Off) and the SSR opens.

The eight digital inputs are referenced to the MLS controller common; an open input pulls them High (Off). When you short the input to controller common the input goes Low (On). Do not connect external power sources to the MLS' digital inputs.

Front Panel Description

The MLS-PM's panel mounted LCD screen and touch keypad provide an intelligent way to operate the MLS. The on-board display driver operates the liquid crystal display. The LCD has 16 alphanumeric or graphic characters per line; it is backlit for viewing under low light conditions. The 8-key keypad and on-board keyboard scanner allow you to change the MLS' operating parameters, controller functions, and displays.

The MLS' information-packed displays show process variables, setpoints, and output levels for each loop. A bar graph display, single loop display, scanning display and an alarm display offer a real-time view of process conditions. Two access levels allow operator changes and supervisor changes. The front panel looks like this:

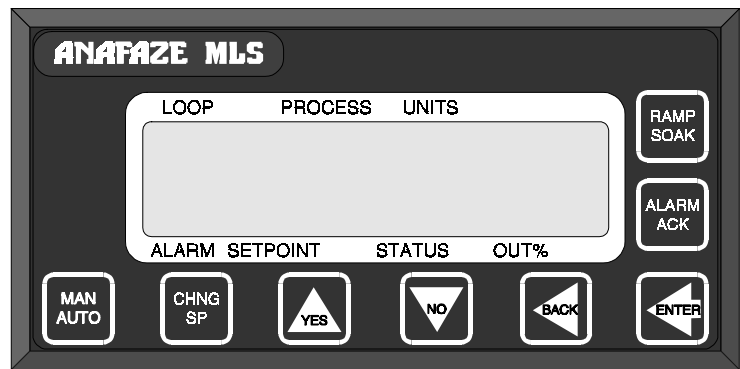

MLS RTB Technical Description

Here's a picture of the RTB:

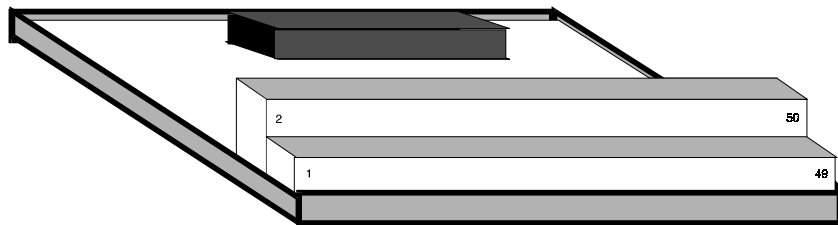

The RTB is a screw terminal interface for control wiring which allows you to easily connect external "real world" wiring to the MLS. The RTB connects a 50-pin flat ribbon cable to a screw terminal block which accepts #18 or #20 AWG wires. The ribbon cable receptacle has a locking latch which keeps the cable in place.

The RTB's 34 digital outputs are sink outputs referenced to the +5 Vdc power supply of the MLS Controller. They are Low when the output is On. The firmware allows you to globally change the alarm and control outputs' default state (no alarms) from On to Off for System Safe output. The outputs are rated at a continuous 10 mAdc if all outputs are On at the same time. Initial power up current should not exceed 20 mAdc.

MLS-AIM and AIM-TB Technical Description

The MLS Analog Input Module (MLS-AIM), containing the AIM-TB (AIM Terminal Board) and AIM's plug-in cards, receive input signals from sensors and pass them to the MLS-PM.

The MLS-AIM-TB contains the power supply terminals, input signal wiring screw terminals, input signal conditioning circuits, and terminal connections for the AIM's plug-in cards. It also contains a cold junction temperature sensor and room for the input scaling resistors, if required. (RTDs, inputs greater than 60 mVdc, and mAdc current inputs require input scaling resistors.) The AIM-TB has three slots for the plug-in AIM cards.

There are two versions of the MLS-AIM: the AIM-16 and AIM-32. The AIM-16 has one multiplexer (MUX) card, and the AIM-32 has two MUX cards. These cards multiplex the 16 inputs each card receives. Each -10 to 60 mVdc input is converted to a voltage that is transmitted to the Voltage/Frequency (V/F) card. (The MUX cards also automatically calibrate the zero and span of the analog amplifier and measure the cold junction compensation temperature for thermocouple (T/C) inputs.) Both the AIM-16 and AIM-32 have a V/F card, which converts the input signal they receive from a voltage to a frequency. The converted signal is then transmitted via the AIM COMM cable to the MLS-PM for processing.

Here's a picture of the MLS-AIM-32 and terminal block:

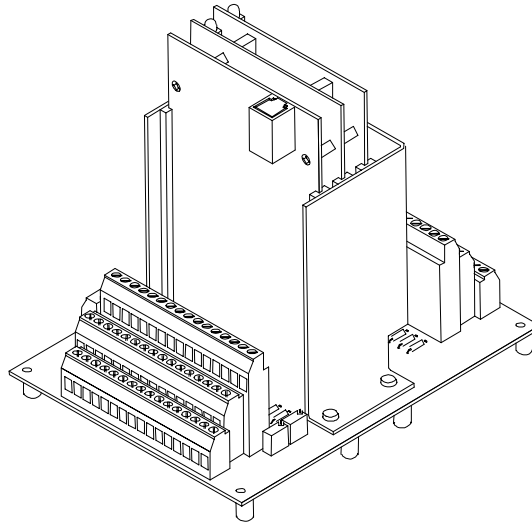

MLS Cabling Technical Description

Watlow-Anafaze provides all the cables required to install your MLS.

The 50 pin ribbon cable which connects the RTB to the MLS-PM is an 0.05 space conductor-zoned 50 pin cable. Pin #1 is at the red edge of the cable.

The cables which connect the MLS-PM to the AIM-TB, the optional Smart I/O Module (SIOM) and the computer are 6-conductor shielded cable. (These cables are also known as RJ12 cable; they are available from Newark Electronics and other suppliers.)



WARNING

These cables are not standard phone cables; standard cables are not shielded. Watlow-Anafaze pin numbering convention is also reversed.

Installation

These installation instructions are written for nontechnical users. If you are an electrician or you are technically proficient, they may seem simple to you. Please at least skim all of the instructions, to make sure you don't miss anything vital. (If you have installed a Modular Loop System before, you may wish to use the Quick Start foldout to install this system.)

This section explains installation for the MLS Controller only. If you are installing another Watlow-Anafaze product (such as a Relay Interface Board, IRSM, or an SDAC), see the manual shipped with it to learn how to install it.

These symbols are used throughout this manual:



DANGER

This symbol warns you about a hazard to human life.



WARNING

This symbol warns you of possible damage to property or equipment.



NOTE

This symbol denotes information you must know in order to proceed.

Read This Before Installation



WARNING

During installation and wiring, place temporary covers over the housing slots and the rear of the MLS so dirt and pieces of wire don't fall through the slots. When you are finished with installation, remove the covers.

Install the MLS so the airflow to the slots in the housing is not restricted after installation. Make sure that other equipment does not block airflow to the housing slots.

Use #18 or #20 AWG wires and trim wire insulation to 1/4" (5 mm). Wire should fit inside the terminal with no bare wire exposed, to prevent contact between wires and the grounded case. Tin any stranded wire.

Support power, input and output cables to reduce strain on the terminals and to prevent wire removal.



DANGER

Shut off power to your process before you install the MLS. High voltage may be present even when power is turned off! Reduce the danger of electric shock after installation--mount the MLS in an enclosure that prevents personal contact with electrical components.

The MLS measures input signals that are not normally referenced to ground, so the MLS inputs and other signal lines can have high voltage present even when power is turned off--for example, if you inadvertently short a thermocouple to the AC power line.



NOTE

Choose a panel location that leaves enough clearance to install and remove the MLS and its components.

Recommended Tools

This section lists the tools you will need to install the MLS Controller.

Panel Hole Cutters

Use any of these tools to cut a hole in the panel:

- A jigsaw and metal file--for stainless steel and other heavyweight panel doors.
- A Greenlee 1/8 DIN rectangular punch (Greenlee part #600-68)--for most panel materials or thicknesses.
- A nibbler and metal file--for aluminum and other lightweight panel doors.

Other Tools

You'll also need these tools:

- A Phillips head screwdriver.
- A flathead screwdriver for wiring.
- A multimeter.
- A phone connector crimping tool made of metal (optional).

Watlow-Anafaze provides all the cabling for the Modular Loop System. If you have special cabling requirements and you make your own RJ12 cable, use a metal crimping tool for the connectors. (A metal tool makes better connections than a plastic tool.)

Additional Hardware

The following additional hardware is also shipped to you:

- Four #6 screws for mounting the AIM-TB.
- #10 screws for mounting the optional MLS Power Supply.

Mounting the MLS-PM

This section tells you how to mount the MLS-PM.



NOTE

Mount the MLS-PM before you mount any other component of the MLS. The processor module's placement affects placement and wiring for the MLS-AIM, MLS-PS, etc.

Mounting Environment

Install the MLS-PM in a location free from excessive (>50 °C) heat, dust, and unauthorized handling. The MLS-PM's 1/8 DIN package can mount in panels up to 0.2" thick. Its dimensions are 1.89" x 3.78" x 6.1" (48 x 96 x 156 mm), as shown below.

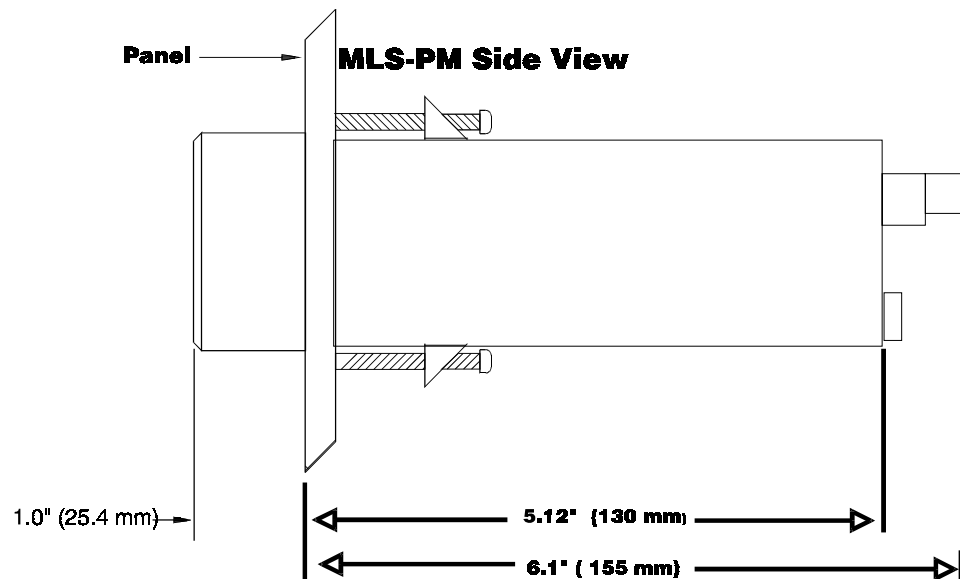

MLS-PM Mounting Steps

1. Use the template below to cut a hole in the panel. Be careful; the 0.02" (0.5 mm) tolerances don't allow much room for error. Use a punch, nibbler, or jigsaw; file the edges of the hole.

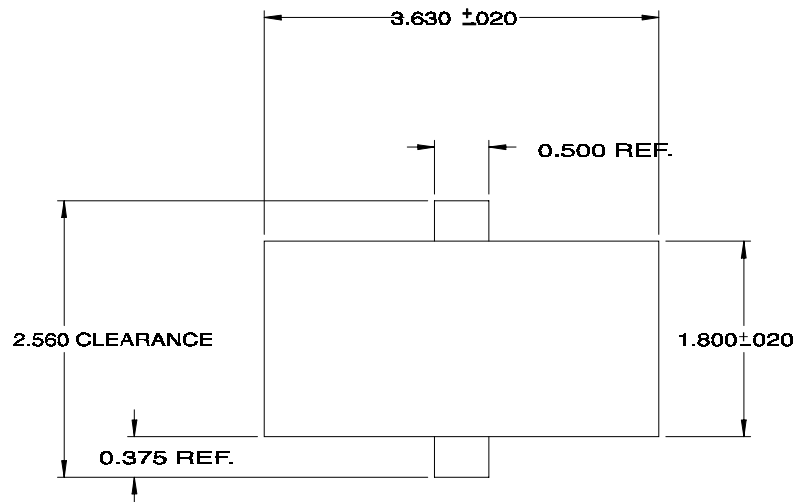

WARNING

Make sure bits of wire and debris do not lodge in the electronics, or else make sure you clean the electronics before you connect power.

2. Insert the MLS-PM into the hole through the front of the panel.
3. Screw the top and bottom clips in place. If you expect much panel vibration, use a rear support for the MLS and its interconnecting cables.

Mounting the MLS-AIM

This section contains mounting instructions and diagrams for the MLS-AIM.



NOTE

If you plan to install scaling resistors, mount them on the AIM-TB before you mount the AIM-TB in the panel. (If you mount the AIM-TB in the panel before you mount the scaling resistors on it, you will have to remove the AIM-TB from the panel to install the scaling resistors.)

If you ordered an MLS-AIM-TB with scaling inputs from Watlow-Anafaze, the scaling resistors are already installed.

Mounting Environment

Install the MLS-AIM in a location free from excessive ($>50^{\circ}\text{C}$) heat, dust, and unauthorized handling.

The MLS-AIM measures 6.5" x 5" x 7" (165 x 127 x 178 mm). Leave 6" of clearance above the MLS-AIM, so you can remove the entire unit (or just the AIM cards) if necessary.

The figure on the next page shows an overhead view of the AIM-TB and MUX cards, with dimensions, scaling resistor locations and hole locations. It also shows the AIM communications port and the insertion of the MUX cards in the AIM Terminal Block.

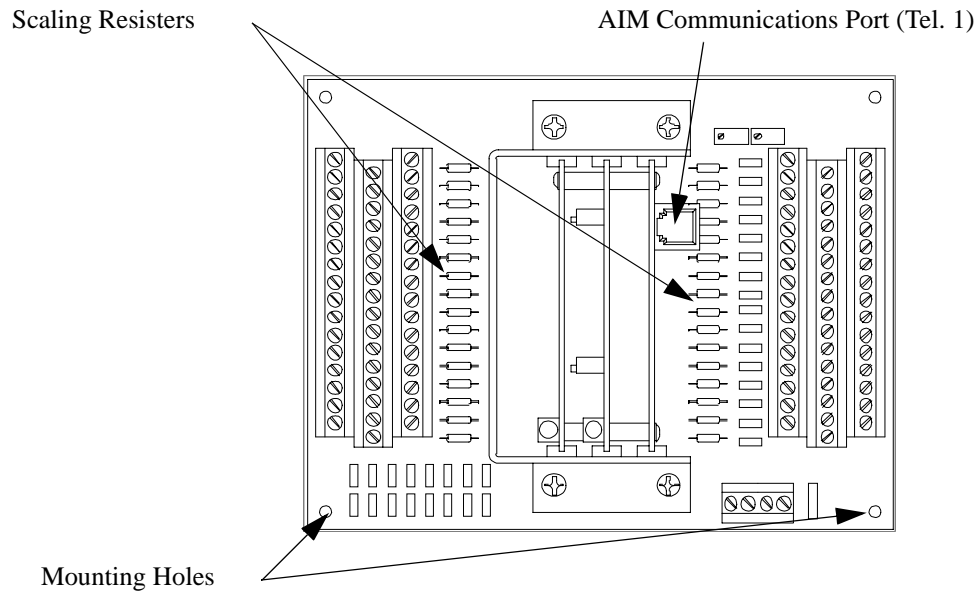

Mounting Steps

1. Choose an appropriate place to install the MLS-AIM.
2. Place the MLS-AIM where you will mount it and use a pencil to trace around the plastic standoffs on the AIM. (If you wish, you can use the AIM mounting template in the Quick Start foldout to position the holes.)
3. Drill four #6 or #8 holes in the chosen location. (#8 holes provide more clearance.)
4. Place the MLS-AIM where you will mount it. Insert the #6 screws in the plastic standoffs and tighten them. You may use self-tapping screws instead, but be sure to remove any loose metal filings after you are finished mounting the MLS-AIM. Use 3/4" screws with internal star lock washers to ensure a good Frame Ground connection.

Mounting the RTB

To mount the RTB, slide it onto a DIN rail. Watlow-Anafaze recommends Phoenix Contact's NS32 perforated DIN rail (part number 12-01-00-2). Mount the DIN rail according to Phoenix Contact's instructions and slide the RTB onto it.



WARNING

Do not connect power to the MLS now. Test the unit first, as explained in the *Power Wiring and Controller Test* section.

Mounting the MLS-PS

Follow these instructions to mount the MLS-PS.

If you use your own power supply for the MLS, please refer to the power supply manufacturer's instructions for mounting information. Choose a power supply that supplies a regulated 7-28 Vdc at 1 watt, and isolated return line.

Mounting Environment

The MLS-PS measures 1.75" x 8" x 5". Leave enough clearance around the power supply that you can remove it later.

Mounting Steps

The MLS-PS has a bracket at each end of the unit. Each bracket has three screw holes which will accept #6 or #10 screws. To mount the MLS-PS, insert screws into the brackets and tighten them.

Wiring Your System

This section explains how to wire the components of your system.

Below is the system connections diagram reprinted here for your convenience. (See the next page for wiring instructions.)

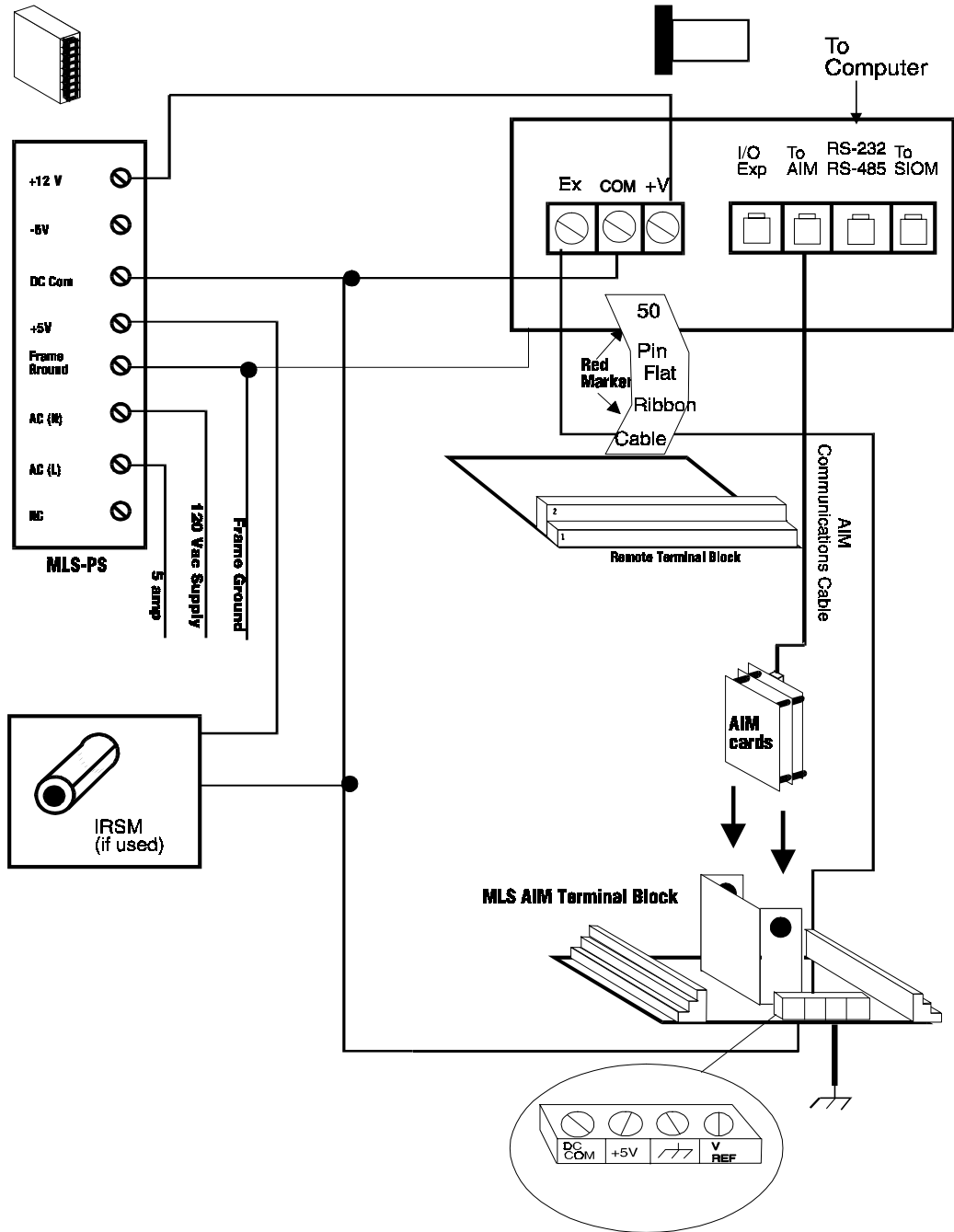

Wiring Recommendations

This section gives general wiring recommendations.



DANGER

Never wire bundles of low power Watlow-Anafaze circuits next to bundles of high power AC wiring. Instead, physically separate high power circuits from the controller. If possible, install high voltage AC power circuits in a separate panel.

- Use stranded wire. (Use solid wire for fixed service; it makes intermittent connections when you move it for maintenance.)
- Use #18 or #20 AWG wire. Larger or smaller sizes may be difficult to install, may break easily, or may cause intermittent connections.
- Use shielded wire. (The electrical shield protects the MLS from electrical noise.) Connect one end of the **input wiring shield** to the MLS panel's 120 Vac panel ground, and connect one end of the **output wiring shield** to the MLS panel's 120 Vac panel ground. (If your system requires a different shield configuration, contact Watlow-Anafaze for more information.)

For more information about noise suppression, see **Noise Suppression**.

Cable Recommendations

Use these cables or their equivalent.

Function	MFR P/N	No. of Wires	AWG
Analog Inputs	Belden #9154	2	20
	Belden #8451	2	22
RTD Inputs	Belden #8772	3	20
	Belden #9770	3	22
T/C Inputs	T/C Ext. Wire	2	20
Carbon Probe Input	Belden #88760	2	18
Digital PID Outputs and Digital I/O	Belden #9539	9	24
	Belden #9542	20	24
	Ribbon Cable	50	
Analog Outputs	Belden #9154	2	20
	Belden #8451	2	22
Computer Communication: RS232, RS422, RS485, or 20 ma	Belden #9729	4	24
	Belden #9730	6	24
	Belden #9842	4	24
	Belden #9843	6	24

Noise Suppression

If the MLS outputs control dry-contact EM relays with inductive loads--like alarm horns and motor starters--you may get Radio-Frequency Interference (RFI, or "noise") This section explains how to avoid noise problems; read it before you wire the MLS.

Symptoms of RFI

- The MLS display blanks out and then reenergizes, as if power had been turned off for a moment.
- The process value does not display correctly.
- The MLS CPU may reset; if it does, it loses its' PID output levels.

RFI may also damage the digital output circuit--so digital outputs will not energize. If the digital output circuit is damaged, return the controller to Watlow-Anafaze for repair.

Avoiding RFI

Where possible, use solid state relays (SSRs) instead of electrical-mechanical (EM) relays. If you must use EM relays, try to avoid mounting them in the same panel as Watlow-Anafaze equipment.

Separate the 120 Vac power leads from the low level input and output leads connected to the MLS. Don't run the digital output or PID control output leads in bundles with 120 Vac wires. (Never run input leads in bundles with high power leads--see the **General Wiring** section.)

If you must use EM relays and you must place them in a panel with Watlow-Anafaze equipment, use a .01 microfarad capacitor rated at 1000 Vac (or higher) in series with a 47 ohm, 1/2 watt resistor across the normally open (NO) contacts of the relay load. This network is known as an arc suppressor or snubber network.

You can use other voltage suppression devices, but they are not usually required. For instance, you can place a metal oxide varistor (MOV) rated at 130 Vac for 120 Vac control circuits across the load, which limits the peak AC voltage to about 180 Vac. You can also place a transistor (back to back zener diodes) across the digital output, which limits the digital output loop to 5 Vdc. (You can get these parts from Watlow-Anafaze.)

The above steps will eliminate most noise problems. If you have further problems or questions, please contact Watlow-Anafaze.

Wiring and Testing Your System

After you install each component of the MLS, use this section to connect them. If these instructions are not clear to you, refer to the system connections diagram for more information. (These instructions are written for non-electricians. If you are an experienced electrician, they may seem elementary to you. If so, feel free to skim them.)

When you have connected each component of your system, install and connect input and output devices. For help with inputs and outputs, see the Outputs and the Inputs sections in this chapter.

Connecting Power and RTB to MLS-PM

1. Remove the temporary covers you placed on the MLS' housing.
2. Connect the power supply terminal labeled "DC COM" to the terminal labeled "GND" on the Processor Module. This terminal is DC common; it is not frame, chassis or earth ground.
3. Connect the power supply terminal labeled "+12V" to the terminal labeled "+V" on the Processor Module.
4. Connect the 50-pin ribbon cable to the Processor Module. Plug it in so that the red stripe is on the left side, under TB1.
5. Connect the ribbon cable to the RTB. Plug it in so that the red stripe is closest to screw terminal 1.

Connecting Power and Common to AIM-TB

1. Connect the terminal labeled "EX" on TB1 of the MLS-PM to the terminal labeled "+5V" on the MLS-AIM.
2. Connect the terminal labeled "COM" on TB1 of the MLS-PM to the MLS-AIM terminal labeled "DC COMMON".

3. Plug the AIM communications cable into the slot on the MLS-PM labeled "To AIM".
4. Plug the other end of the AIM communications cable into the slot on the MLS-AIM labeled "Tel 1". (The slot is on top of the V/F card.)



WARNING

Do not turn on the AC power now. Test the connections first, as explained below.

5. Connect AC power wires to the MLS-PS.
6. Connect "  " terminal on MLS AIM to frame Ground.

Testing Connections



WARNING

Reversed polarity or incorrect voltage to the PM or AIM will damage your MLS, and you will need to return it to Watlow-Anafaze for repair. Please don't damage your unit! Read this section completely and follow the steps below before you apply power to your MLS.

1. Unplug TB1 (the green block which contains the Ex, GND, and +V terminals) from the MLS-PM.
2. Unplug the AIM cards from the AIM-TB:
 - Carefully insert a screwdriver in the hole on the side of the AIM's metal jacket.
 - Gently press the screwdriver blade against the metal standoffs which separate the AIM cards.
 - Continue pressing gently until the AIM cards pop loose from the plastic bracket that holds them in place. Then, carefully grasp the AIM cards by the edges and remove them from the metal bracket.

You have removed the parts of the MLS which will be damaged by excess voltage, so turn on the AC power and use a voltmeter to check voltages:

3. Touch the meter Common lead to the "COM" terminal on the MLS-PM (the green block with the wires). The voltage on the "+V" terminal of the MLS-PM should be +10 to 28 Vdc. The voltage on the "EX" terminal of the MLS-PM should read 0 Vdc.
4. If the voltages are within the limits described above:
 - Turn off the power.
 - Plug TB1 (the green block which contains the screw terminals) back into the MLS-PM.

- Turn the power back on. The Processor Module's display should light up, and after about a second the Bar Graph display should appear, followed by the message "AIM COMM FAIL".
5. Connect the Common lead of the voltmeter to TB3 and the power lead of the voltmeter to the AIM-TB terminal labeled "+5V". The voltage on the "+5V" terminal should be between +4.75 and +5.25 Vdc.
 6. If the voltages are within the limits described above:
 - A. Turn off the power.
 - B. Carefully insert the AIM cards back into the AIM Terminal Block.
 - C. If you have unplugged the AIM COMM. cable, plug it back in.
 - D. Press and hold the No key. While pressing it, turn the power back on. (This procedure is known as a manual controller reset or No Key reset.)

The green LEDs on the AIM should blink, which means that the unit is working normally. If they do not blink, contact Watlow-Anafaze.
 - E. The MLS-PM will display a "T/C Break" alarm message for each channel. These messages are normal; to clear them, press Alarm Ack once for each control loop.

Testing Your System

This section explains how to test the controller after installation.

MLS-AIM Test

Use this procedure to test the MLS-AIM before you connect inputs to it.

1. Connect a wire from the A+ terminal for loop 1 to the A- terminal for loop 1.
2. Turn on power to the MLS-PM.
3. Press the **ALARM ACK** key to clear the alarm messages displayed on the MLS-PM's screen.
4. Press the **YES** key to reach the single loop display for Loop 1. The MLS-AIM-TB contains an ambient temperature sensor, so Loop 1 should display room temperature. If it does not, contact Watlow-Anafaze.

RTB Test

1. Turn on power to the MLS.
2. Measure the +5Vdc supply at the RTB:
 - A. Connect the voltmeter's Common lead to RTB terminal #3.
 - B. Connect the voltmeter's Power lead to RTB screw terminal #1. The voltage should be 4.75 to 5.25 Vdc.
 - C. Connect the Power lead to RTB screw terminal #2. The voltage should be 4.75 to 5.25 Vdc.
 - D. Connect the Power lead to RTB screw terminal #4. The voltage should read 0 volts.

PID Output Test

1. Connect the voltmeter power lead to RTB screw terminal #1.
2. Connect the Common lead to the PID output pin.
3. If you have not connected a load to the output, connect a 500 ohm to 100 Kohm resistor between RTB screw terminal 1 and the PID output pin.
4. Use the digital output test (in the Manual I/O Test menus) to turn the digital output on and off. When the output is off, the output voltage should be less than 1V. When the output is on, the output voltage should be between 3.75 and 5.5V.

**NOTE**

Your MLS is shipped with heat outputs enabled and cool outputs disabled. You can disable any PID output and use it for other digital output functions. All digital outputs and PID outputs are sink outputs referenced to the 5Vdc supply. These outputs are Low when they are On.

All digital inputs are Transistor-Transistor Logic (TTL) level inputs referenced to control common.

Outputs

This section discusses the MLS' PID control and alarm outputs.

**WARNING**

Control outputs are connected to the MLS's logic ground when the control output is On (Low). Be careful when you connect external devices that may have a low side at voltage other than controller ground, since you may create ground loops.

If you expect grounding problems, use isolated solid state relays and isolate the control device inputs.

The MLS provides dual PID control outputs for each loop. These outputs are on the 50 pin ribbon cable connector which connects to the RTB. You can enable or disable them.

- The default setting is heat outputs enabled, cool outputs disabled.
- You can program each output for on/off, TP, or DZC control.
- You can program each output for direct or reverse action.
- You can program a deadband for heat/cool; within that deadband both outputs will be Off.

Output Wiring Recommendations

When you wire output devices to the RTB, use multicolored stranded shielded cable for analog outputs and PID digital outputs connected to panel mount SSRs.

- Analog outputs usually use a twisted pair.
- Digital outputs have 9 to 20 conductors, depending on wiring technique.

Ribbon Cable Recommendations

Use the 50-pin connector for both ends of the 50 pin flat ribbon cable. (Do not connect either end to a screw terminal; the cable wire is too small to withstand much flexing.)

Do not exceed 15' of 50-conductor cable.

Using the Cable Tie Wraps

When you have wired outputs to the TB-50, install the cable tie wraps shipped with it. This diagram shows the cable tie wrap holes.

Each row of terminals has a cable tie wrap hole at one end. Thread the cable tie wrap through the cable tie wrap hole. Then wrap the cable tie wrap around the wires attached to that terminal block.

PID Control and Alarm Output Connections

Typical digital control outputs use external optically-isolated solid-state relays (SSRs). The SSRs use a 3 to 32 Vdc input for control, and you can size them to switch up to 100 amps at 480 Vac. For larger currents, use these optically-isolated relays to drive contactors.



NOTE

Control outputs are sink outputs. They are Low when the output is On. Connect them to the negative side of Solid State Relays.

The next figure shows sample heat/cool and alarm output connections.

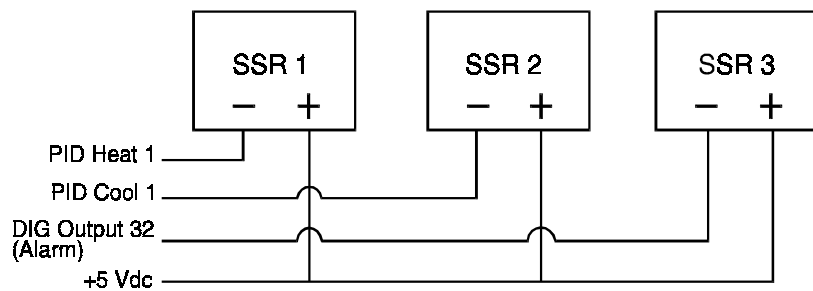

System Safe (Watchdog Timer) constantly monitors the MLS CPU. It is a SINK output located on RTB terminal #6. (Do not exceed the 10 mAdc rating for the System Safe output.) Its output is Low (on) when the CPU is operating; when it stops operating, the output goes High (off), de-energizing the SSR.

Here's the recommended circuit for the System Safe output:

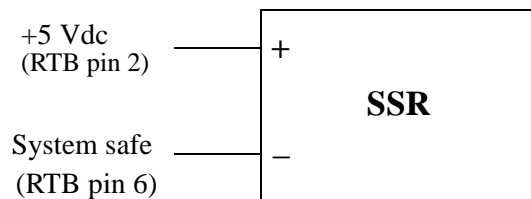

RTB Connections

Connect outputs to the RTB as shown in the table below.

Terminal	Function	PID Output	Terminal	Function	PID Output
1	+5 Vdc		2	+5 Vdc	
3	CTRL COM		4	CTRL COM	
5	Spare		6	System Safe	
7	Pulse input		8	Global Alarm	
9	DIG Output 1	Heat 1	10	DIG Output 34*	
11	DIG Output 2	Heat 2	12	DIG Output 33	Pulse Loop Heat
13	DIG Output 3	Heat 3	14	DIG Output 32	Heat 32/Cool 16
15	DIG Output 4	Heat 4	16	DIG Output 31	Heat 31/Cool 15
17	DIG Output 5	Heat 5	18	DIG Output 30	Heat 30/Cool 14
19	DIG Output 6	Heat 6	20	DIG Output 29	Heat 29/Cool 13
21	DIG Output 7	Heat 7	22	DIG Output 28	Heat 28/Cool 12
23	DIG Output 8	Heat 8	24	DIG Output 27	Heat 27/Cool 11
25	DIG Output 9	Heat 9	26	DIG Output 26	Heat 26/Cool 10
27	DIG Output 10	Heat 10	28	DIG Output 25	Heat 25/Cool 9
29	DIG Output 11	Heat 11	30	DIG Output 24	Heat 24/Cool 8
31	DIG Output 12	Heat 12	32	DIG Output 23	Heat 23/Cool 7
33	DIG Output 13	Heat 13	34	DIG Output 22	Heat 22/Cool 6
35	DIG Output 14	Heat 14	36	DIG Output 21	Heat 21/Cool 5
37	DIG Output 15	Heat 15	38	DIG Output 20	Heat 20/Cool 4
39	DIG Output 16	Heat 16	40	DIG Output 19	Heat 19/Cool 3
41	DIG Output 17	Heat 17/Cool 1	42	DIG Output 18	Heat 18/Cool 2
43	DIG Input 1		44	DIG Input 2	
45	DIG Input 3		46	DIG Input 4	
47	DIG Input 5		48	DIG Input 6	
49	DIG Input 7		50	DIG Input 8	

* If you install an Watlow-Anafaze Serial Digital to Analog Converter (SDAC), the MLS uses digital output #34 for a clock line. You cannot use output #34 for anything else when an SDAC is installed.

AIM Communications Failure

The controller continuously checks communications between the MLS-PM and the AIM. If communication stops for more than five seconds, the MLS-PM display indicates AIM COMM FAIL, the PID mode changes to manual, and the controller sets every output to the output override percentage.



WARNING

PID outputs remain in manual mode after an AIM communications failure. After an AIM failure, change the PID control status back to automatic mode for each control loop.

An AIM communications failure also activates the global alarm output. If you have selected a digital output from the Global Parameters menu, an AIM communications failure also activates the output.

Inputs

This figure shows the AIM cards (also known as the MUX cards) and AIM-TB, with scaling resistor locations.

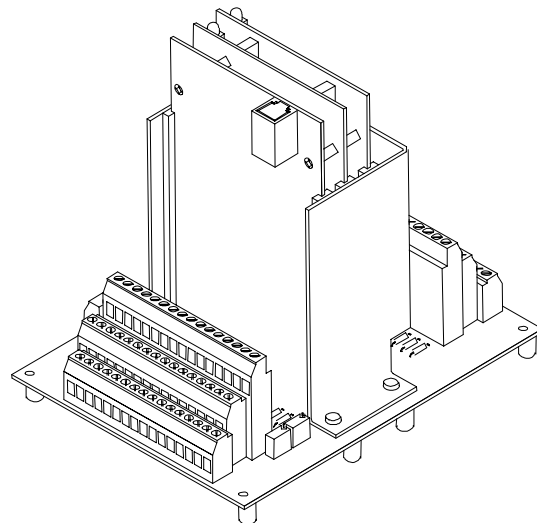
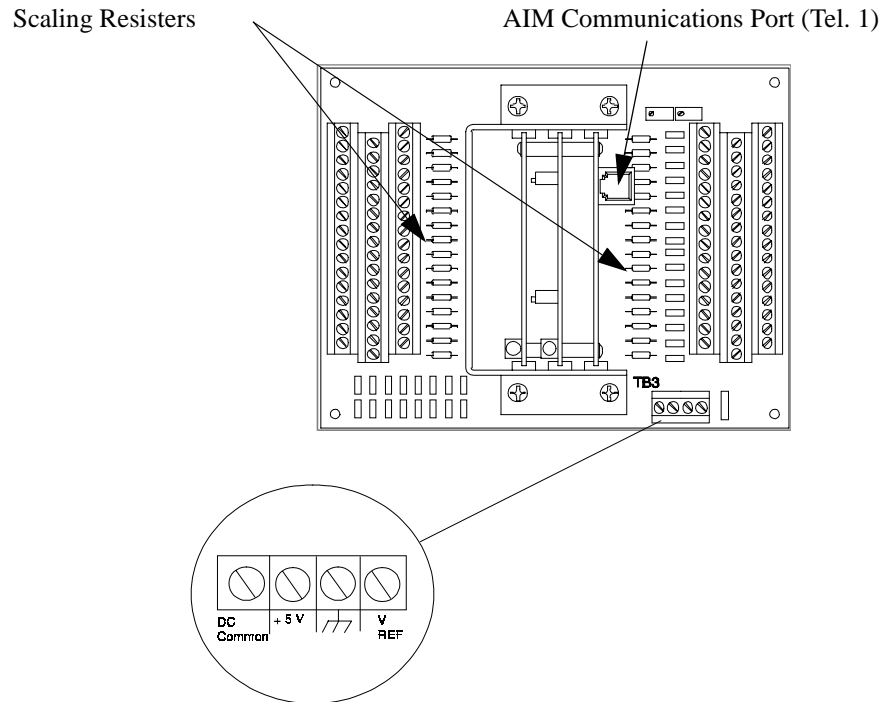

- The loop input number is marked on the terminal block: the number 1 indicates an input for loop 1, the number 2 an input for loop 2, etc.
- The A+ terminal is the positive input of the analog signal.
- The A- terminal is the negative input of the analog signal.

- The A COM (AUX) terminal is the Auxiliary input. This is analog common used for RTD inputs.



WARNING

Do not exceed 10 Vdc between loops. Excess voltage may damage the Analog Input Module (AIM).

Input Wiring Recommendations

Use multicolored stranded shielded cable for analog inputs. Watlow-Anafaze recommends that you use #20 AWG wire. (If the sensor manufacturer requires it, you can also use #22 or #24 AWG wiring.) Most inputs use a shielded twisted pair; some require a 3-wire input.

Input Scaling

You can connect thermocouples, 4-20 mA current inputs, voltage inputs, and 2- or 3- wire RTD inputs to the MLS. If you need to scale input voltages or convert milliamp inputs to match the -10 to 60 mV (-16.7% to 100%) input range, install scaling resistors. Watlow-Anafaze can supply factory-installed input scaling resistors--order option MLS-SI-XX (See the next table for standard scaling resistor values), or special input kits MLS-SIK-XX (call Watlow-Anafaze for XX number).

Scaling Values

- Scaling values for mVdc ranges are standard metal film values with $\pm 0.25\%$ accuracy if 0.1% tolerance resistors are used.
- Scaling values for mAadc ranges are 0.1% tolerance with $\pm 0.10\%$ accuracy.
- Scaling values for RTD ranges are 0.05% tolerance. Use these values to remain within factory specifications for the RTD inputs.
- Use 0.1% metal film, 1/4 watt resistors. Higher tolerances may cause significant errors. Use the MLS' built-in linear scaling to correct any errors due to resistor tolerance. You can also install other components (like capacitors) for signal conditioning; please consult Watlow-Anafaze for more information.

This figure shows an input circuit. RA, RB, RC, and RD refer to the scaling resistor locations printed on the MLS-AIM's terminal board.

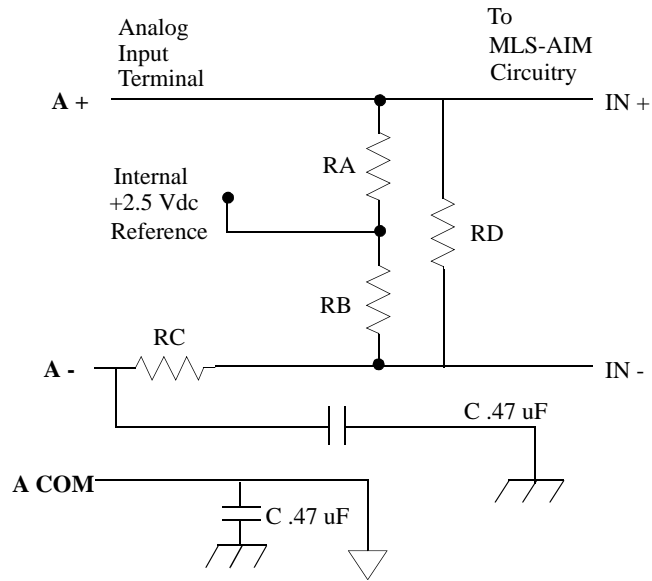

This table shows scaling resistor values.

Input Range	RA	RB	RC	RD
All T/C, 0-60 mVdc			Jumper	
RTD1, -100.0 to 300.0°C	5.49K	5.49K	80	
RTD2, -120 to 840°C	11.0K	11.0K	100	
RTD3, -70 to 300°C	11.0K	11.0K	100	
0-10 mAdc	-450 to		Jumper	6.0
0-20 mAdc (4-20 mA)	2500		Jumper	3.0
0-100 mVdc			499	750
0-500 mVdc			5.49K	750
0-1 Vdc			6.91K	422
0-5 Vdc			39.2K	475
0-10 Vdc			49.9K	301
0-12 Vdc			84.5K	422

Input Calibration

The MLS provides offset calibration for T/C, RTD, and other fixed ranges. It also provides offset and span (gain) calibration for linear and pulse inputs. (Offset and span calibration convert linear analog inputs into engineering units using the $Mx+B$ function.) The offset range is -300 to +300 units; the magnitude of the offset depends on the input type and span you select.

Follow these steps to use the MLS' offset and span calibration:

1. Install scaling resistors that will provide an appropriate full scale voltage. (If you have any doubts about your ability to install scaling resistors, contact Watlow-Anafaze.)

2. Select the # of digits and decimal point location for the full scale PV display. The smallest possible range is -0.9999 to +3.0000; the largest possible range is -9999 to 30000.
3. Enter the zero and full scale values (process variables) you want displayed when the input signal is at zero and full scale.

T/C Inputs



WARNING

Use ungrounded thermocouples (thermocouples which have the T/C junction isolated from the metal protection sheath). Grounded thermocouples will damage the MLS if voltage between the loops exceeds 10 volts.

If you are installing the MLS in an existing temperature control system, check all grounded T/C assemblies in the system. Make sure there is no voltage between T/C leads.

You can connect all T/C types directly to the MLS. Watlow-Anafaze provides J, K, T, R, S, and B type linearization and cold junction compensation. (Other thermocouple types require custom input ranges; contact Watlow-Anafaze for more information about them.)

Wiring Recommendations

Follow these recommendations for thermocouple wiring:

- Use 18 or 20 AWG thermocouple (T/C) extension wire for all thermocouple inputs.
- Most T/C wire is solid unshielded wire. Use shielded wire if required at your installation; ground one end only.
- Use less than 500' of T/C extension wire. Longer wire runs exceed accuracy and source impedance specifications.
- Install T/C wiring in a separate conduit away from AC power (the 120 Vac supply) and high power (240 Vac or higher) wiring.

Connecting Thermocouples

Connect the positive T/C lead to the A+ terminal. Connect the negative T/C lead to the A- terminal of TB1. The figure below shows a typical thermocouple connection.

- Use 20 gauge T/C extension wire for all T/C inputs.
- If you use shielded wire, tie the shield to panel ground.
- Install a jumper or zero ohm resistor in location RC on the AIM-TB if it had been removed.

This figure shows a typical thermocouple connection.

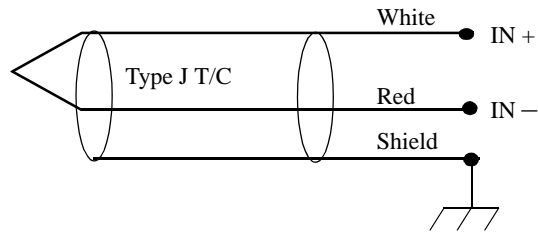

RTD Inputs

The standard industrial RTD is an 100 ohm, three-wire, platinum assembly as shown in the next figure. Watlow-Anafaze highly recommends that you use the three-wire RTD to prevent reading errors due to cable resistance.

- If you order an RTD1, RTD2, or RTD3 configuration, we will configure your MLS for the standard three-wire RTD.
- If you must use a two-wire RTD, jumper A- to AUX.
- If you must use a four-wire RTD, do not connect the fourth wire.

Watlow-Anafaze offers three standard DIN 385 curve RTD input ranges, as shown in the table below:

RTD Type	Input Range	Display Resolution
RTD1	-100.0 to 300.0 C -148.0 to 572.0 F	0.1 C 0.1 F
RTD2	-120 to 840 C -184 to 1544 F	1 C 1 F
RTD3	-70 to 300 C -94 to 572 F	1 C 1 F

This figure shows a typical 3-wire RTD connection.

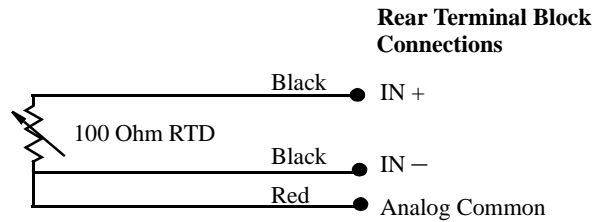

Current Inputs

To install current (milliamp) inputs, place resistors in the input section which convert the milliamp input into a voltage. (You can get different current input ranges if you select different resistor values.) The input connections for these inputs are the same as the input connections for voltage inputs.

Voltage Inputs

Connect the + side of the voltage input to the A+ terminal. Connect the - side of the input to the A- terminal. The voltage input range is -10 to 60 mV. Scale signals larger than 60 mV with a scaling resistor which makes full scale input 60 mV.

The next figure shows two resistors. RA and RB are not loaded. RC is the voltage reducing or current limiting resistor, and RD is the 60 mV full scale dropping resistor. RD is normally less than 500 ohms, and it should never exceed 1000 ohms.

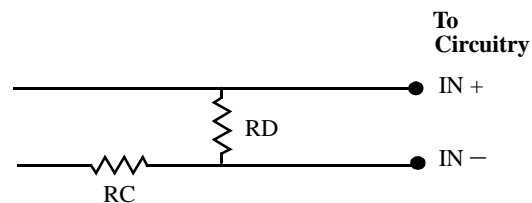

Unused Inputs

Set the input type for unused inputs to "SKIP" to avoid the default T/C break alarms.

Communications

The MLS is factory-configured for either RS-232 or RS-485 communications. When you order your unit, specify the type of communications you need.

- If you use one MLS and you connect it to a computer less than 50 feet away, you can use RS-232 communications.
- If you use more than one computer, or if the computer and controller are more than 50 feet apart, use RS-485 communications.

PC-compatible computers typically use RS-232 communications. If the MLS is configured for RS-232 communications, you can connect it directly to the serial communications connector on an IBM-PC or compatible computer.

If you use RS-485 communications, attach an optically isolated RS-232/RS-485 converter to the computer. You can use an internal converter card or an external plug-in converter.

Changing Communications

Follow these instructions to change the unit's communications between RS-485 and RS-232:

1. Unplug any cables connected to the MLS-PM.
2. If you already installed the MLS-PM in a panel, remove it from the panel.
3. Unscrew the screws on the PM's casing. (There are either two or four screws on the sides of the casing. There are two additional screws on the top of the casing.)
4. Move jumpers JU2, JU4, and JU14 on the upper PC board.
5. If you are changing communications for the last unit on the serial communications line, also move jumper JU3. Installing this jumper places a 200 ohm impedance on the line.
6. Reverse instructions 1-3 to reinstall the unit.

Connecting RS-232 Communications

The RS-232 interface is a standard phone cable with a 6-pin male phone connector on one end and a 9- or 25-pin D-sub female connector on the computer end. (You can order this cable--called an MLS COM cable--from Watlow-Anafaze. If you order it, specify the length of cable and the type of D-sub miniature connector you need.)

1. Plug the phone connector into the slot labeled "RS-232/RS-485" on the rear of the MLS-PM.
2. Plug the D-sub connector into the communications connector.

This table shows RS-232 connections for 25-pin and 9-pin connectors.

Computer Connector		MLS RS-232 Pin Number
DB 25	DB 9	
RX Pin 3	RX Pin 2	TX Pin 5 Yellow
TX Pin 2	TX Pin 3	RX Pin 1 Blue
GND Pin 7	GND Pin 5	GND Pin 4 Green



NOTE

The pin numbers and colors are not industry standard. Watlow-Anafaze numbers the pins from right to left with 1 on the right as you're looking at the back of the MLS-PM. Colors vary depending on the manufacturer. The figure below shows a back of an MLS-PM.

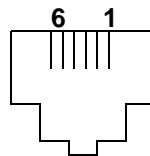

Connecting RS-485 Communications

RS-485 specification is for "balanced line" operation; it is not true differential, so you must supply a common ground connection. Use a fifth wire (which should not be shield, if possible) or a common ground connection to establish the common ground.

Do not use the common ground connection unless the common mode voltage between stations at your installation exceeds the RS-485 specification of 7 volts peak; in that case, use a fifth wire.

The following diagram shows the recommended system hookup. The transmitter from the host computer connects in parallel to the controller receivers, and the host computer receiver connects in parallel to the controller transmitters. Watlow-Anafaze recommends that you use a single "daisy chain" rather than "octopus connections" or "spurs". In addition, use a terminating resistor (a 200 ohm resistor laid across the line at the furthest point from the transmitter) at each end of the transmission line.

This figure shows the MLS RS-485 connections.

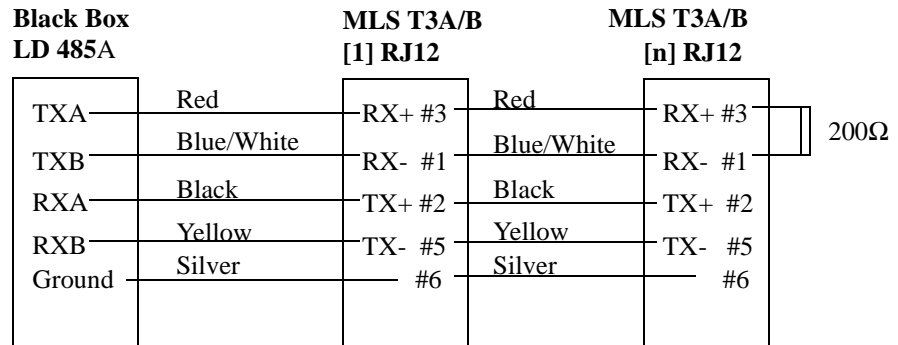

NOTE

Connect the shields to earth ground only at the computer or other 485 interface. Do not connect the shield at the MLS. Connect a 200 ohm terminating resistor between RX- and RX+ at the last MLS (Ju3).

The loop resistance of the transmission line (wire only, not terminating resistor) must not exceed 200 ohms.

This table shows RS-485 connections.

Line	RS-485 Connection	Color
TXB	RX+Pin 1	Blue/White
TXA	RX-Pin 3	Red
RXB	TX+Pin 5	Yellow
RXA	TX-Pin 2	Black
	Ground Pin 4	Green
Shield	Shield Pin 6 (Not jumpered internally)	

EIA Standard RS-485 specifies the electrical characteristics of transmitters and receivers for digital multi-point systems. Watlow-Anafaze equipment meets RS-485 and RS-422 standards. However, RS-485 does not specify transmission lines, signaling rates, protocols, etc. Watlow-Anafaze recommends the following:

- Maximum signaling rate: 9600 baud.
- Twisted shielded pairs for the RS-485 cables.

Recommended Wire Gauges

This table shows maximum distances and wire gauges for communications wiring:

Distance	Wire Gauge	Recommended Cable
4000 ft.	24 AWG	Belden #9729 Belden #9842
6000 ft.	22 AWG	Belden #9184

You may wish to use a shield, depending on your noise environment and grounding problems. These cables are shielded.

Using the MLS

This chapter explains how to use the front panel to operate the controller. (If you are using ANASOFT, see the operation instructions in the ANASOFT User's Guide.) The next figure shows a map of the operator menus and displays accessible from the MLS Controller's front panel. You don't need to enter a passkey sequence to reach these menus.

To make detailed changes to global parameters, loop inputs, control parameters, outputs, and alarms via the setup menus, you must enter a special sequence of keys. (For more information about the Setup menus, see *Chapter 4: Setup*.)

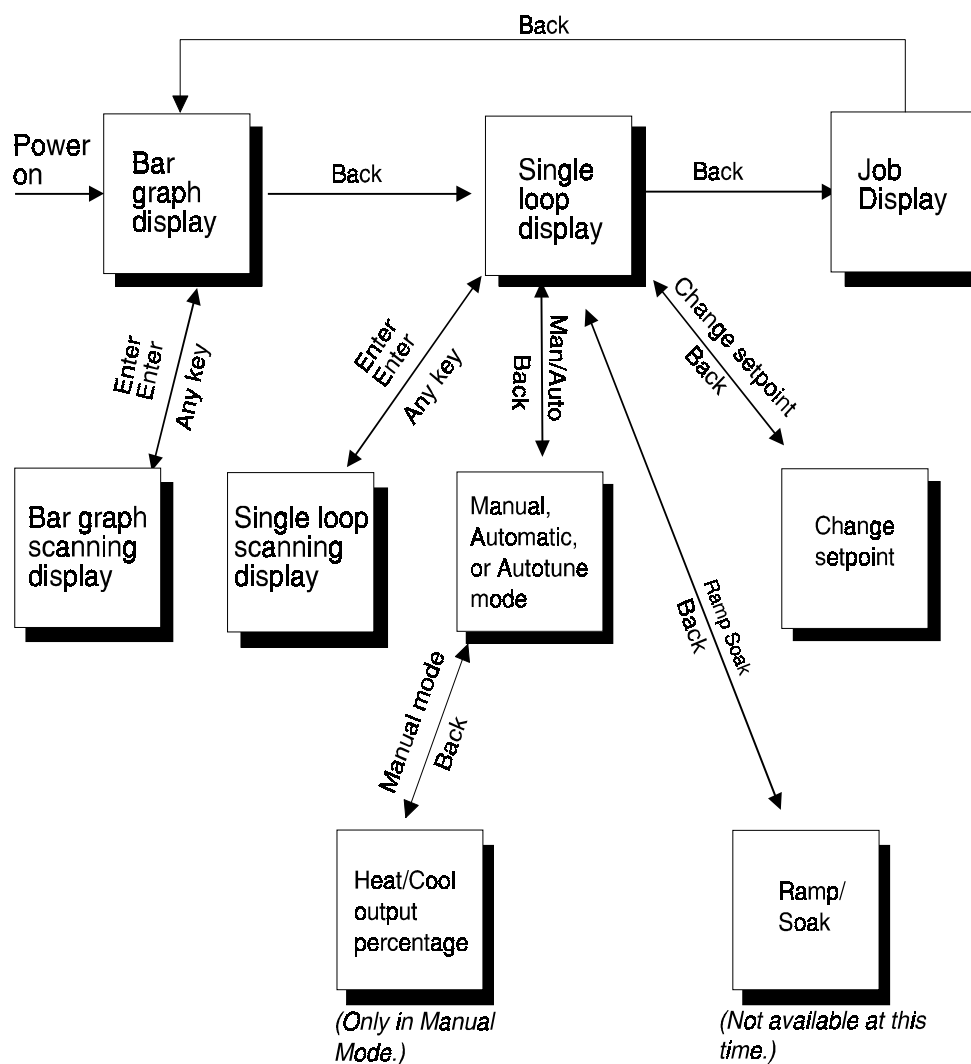

Front Panel

The MLS front panel provides a convenient interface with the controller. You can use the front panel keys to program and operate the MLS, or you can use ANASOFT, a program designed specifically for ANAFAZE controllers. (See the *ANASOFT User's Guide* for more information about ANASOFT, or contact ANAFAZE.)

This figure shows the MLS' front panel.

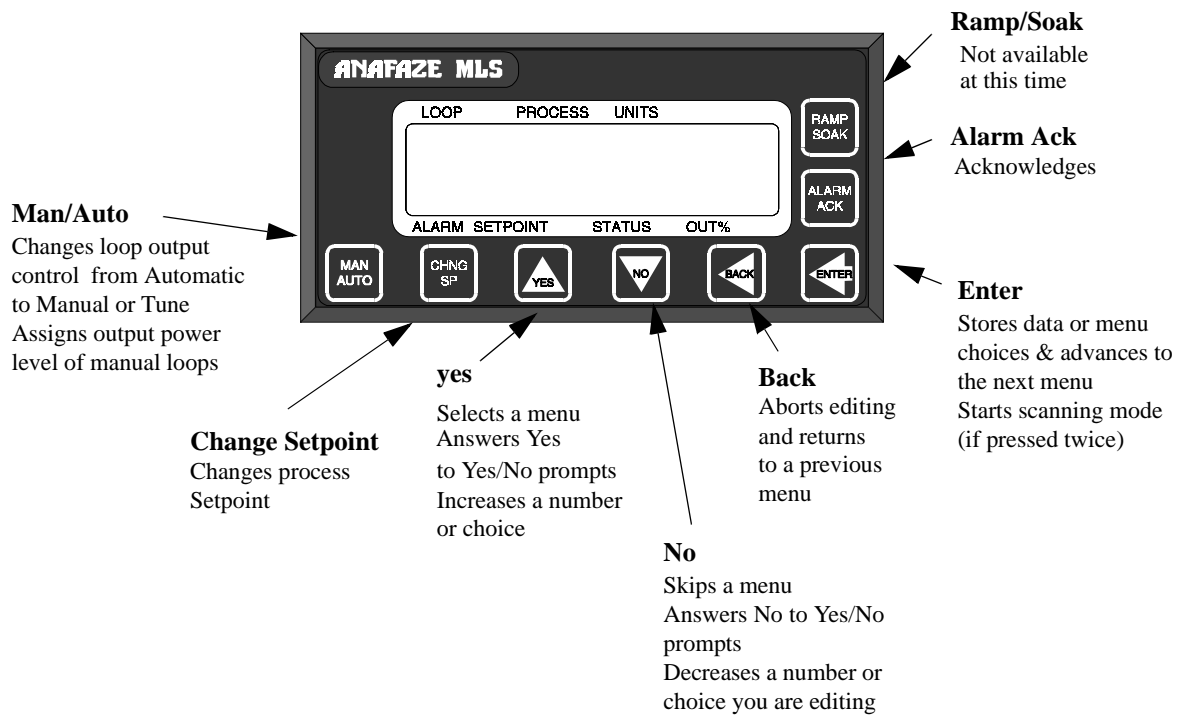

Front Panel Keys



Yes (Up)

Press **Yes** to do these things:

- Select a menu.
- Answer Yes to Yes/No prompts.
- Increase a number or choice you're editing.
- Stop scanning mode.



No (Down)

Press **No** to do these things:

- Skip a menu when the prompt is blinking.
- Answer No to Yes/No prompts.
- Decrease a number or choice when editing.
- Stop scanning mode.
- Perform a manual controller (No Key) reset (see next page).



WARNING

A manual controller (No Key) reset clears the controller's RAM and reinitializes the MLS-PM's factory default values.

A manual controller reset is appropriate in these situations:

- After you change the PROM.
- In some cases when troubleshooting (see *Chapter 6: Troubleshooting*).



Back

The **Back** key works like an "escape" key. Press it to:

- Abort editing.
- Return to a previous menu.
- Stop scanning mode.

- Switch between Bar Graph and Single Loop display.



Enter

Press the "**Enter**" key to:

- Store data or a menu choice after editing.
- Go on to the next menu.
- Start scanning mode (if pressed twice).



Chng SP

- Press this key to change the loop setpoint.



Man/Auto

Press the **Man/Auto** key to:

- Toggle a loop between manual and automatic control.
- Adjust the output power level of manual loops.
- Automatically tune the loop.



Ramp/Soak

Ramp/Soak isn't available for the standard MLS. When pressing this key, a message appears: OPTION UNAVAILABLE.



Alarm Ack

Press **Alarm Ack** to:

- Acknowledge an alarm condition.
- Reset the global alarm digital output.

Displays

This section describes the MLS' displays.

Viewing Several Loops: Bar Graph Display

When you connect power to the MLS, it displays general symbolic information for loops 1-8. This display is called Bar Graph mode. The next figure shows a picture of the Bar Graph display.

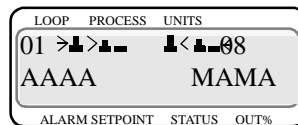

This table explains the symbols on the top line of the Bar Graph display.

Symbol	Symbol's Meaning
<	Loop is in low process or low deviation alarm.
>	Loop is in high process or high deviation alarm.
	Loop is above setpoint. If you enable the high or low deviation alarm, this symbol is scaled to it. If you don't enable these alarms, these symbols are scaled to the setpoint $\pm 5\%$ of the sensor's range.
	Loop is at setpoint. If you enable the high or low deviation alarm, this symbol is scaled to it. If you don't enable these alarms, these symbols are scaled to the setpoint $\pm 5\%$ of the sensor's range.
	Loop is below setpoint. If you enable the high or low deviation alarm, this symbol is scaled to it. If you don't enable these alarms, these symbols are scaled to the setpoint $\pm 5\%$ of the sensor's range.
(Blank)	Loop is set to SKIP.
F	Sensor has failed.

The next table explains the symbols you see on the bottom line of the Bar Graph display and in the Single Loop display. These symbols appear when the controller is in both dual output mode and single output mode. If the process goes into alarm, the controller automatically switches to Single Loop display and shows an alarm code.

Bar Graph Display Symbol	Single Loop Display Symbol	Description
M	MAN	One or both outputs enabled. Loop is in manual control.
A	AUTO	Only one output (Heat or Cool) is enabled. Loop is in automatic control.
T	TUNE	Indication that the loop is in Autotune mode.
H T	HEAT	Both heat and cool outputs are enabled. Loop is in Automatic control and heating.
C L	COOL	Both heat and cool outputs are enabled. Loop is in Automatic control and cooling.
(blank)	(blank)	Both outputs disabled, or input type is set to SKIP.

Navigating in Bar Graph Display

Press the **Yes** (up) or **No** (down) key to see a new group.

- Press **Enter** twice to scan all groups. The groups will display sequentially for three seconds each. This is called Scanning Mode.
- Press **Back**, **Yes** or **No** to go back to Bar Graph display.
- From Bar Graph display, press **Back** once to go to Single Loop display.

Viewing One Loop: Single Loop Display

Single Loop display (below) shows detailed information for only one loop. If the heat and cool outputs are enabled, Single Loop display looks like this:

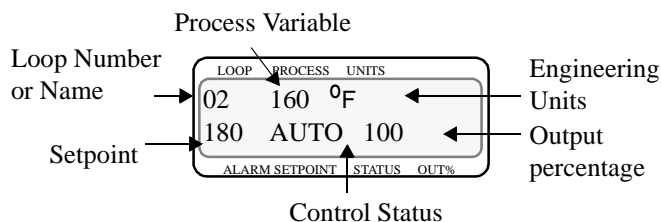

The control status indicator shows HEAT or COOL if the loop is in automatic control, and MAN or TUNE if the loop is in manual control.

If only one output is enabled (heat or cool, but not both), Single Loop display looks like this:

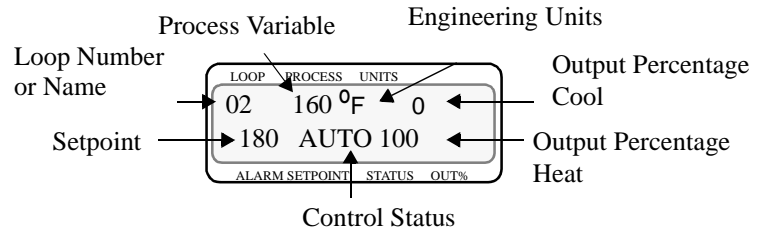

Navigating in Single Loop Display

From the single loop display,

- Press the **Back** key once to get back to Bar Graph display.
- Press **Enter** twice to get to the Single Loop Scanning display. (The Single Loop Scanning display shows information for each loop in sequence. Data for each loop displays for one second.)
- Press **Back**, **Yes**, or **No** to return to the Single Loop display.

Interpreting Alarm Display

If an alarm occurs, the alarm interrupts any other display and switches to the alarm display, as shown in the next figure. If the MLS is in Bar Graph display, it switches to Bar Graph Alarm display. If it is in Single Loop display, it switches to Single Loop Alarm display.

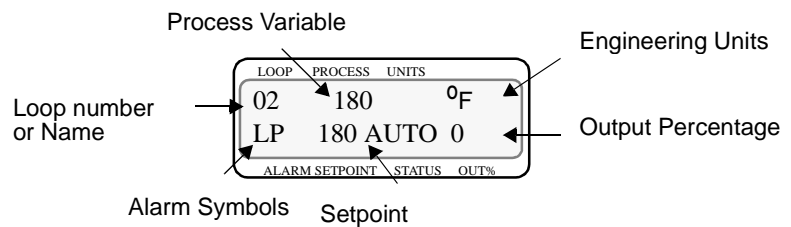
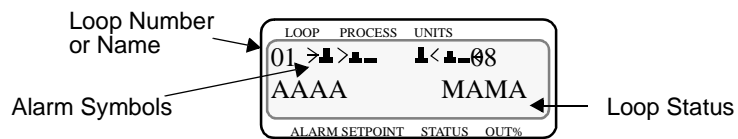

This table shows the symbols used in each form of the alarm display.

Bar Graph Symbol	Single Loop Symbol	Description
>	HP	High Process Alarm
>	HD	High Deviation Alarm
<	LP	Low Process Alarm
<	LD	Low Deviation Alarm
B	T/C Break	Open Input Error
S	RTD Short	RTD Short Alarm
O	RTD Open	RTD Open Alarm
Aim Comm Failure	Aim Fail	MLS-AIM Communications Failure

Acknowledging an Alarm

Press **Alarm Ack** to acknowledge the alarm. If there are other loops with alarm conditions, the Alarm display switches to the next loop in alarm. Acknowledge all alarms to clear the global alarm digital output (The keyboard and display won't work for anything else until you acknowledge each alarm). The alarm symbols are displayed as long as the alarm condition is valid.

Displaying, Loading, and Saving Jobs

Job display appears only if:

- You have turned on the Remote Job Select function. (This function is explained in *Chapter 4: Setup*.)
- You have selected a job from the job load menu.

When you load a job, Job display shows you the following screen:



If you remotely loaded the job, Job display looks like this:



If you modify a job's parameters while the job is running, you'll see this job message:



If an alarm occurs, the controller switches to Single Loop Display.

Operator Menus

You can perform these tasks from Single Loop Display.

Changing the Setpoint

Press **Chng SP** from the loop you want to change. this display appears:



- Press **Yes** to change the setpoint.
- Press **Yes** or **No** to change the setpoint value.
- Press **Enter** to save your changes and return to Single Loop Display.
- Press **No** or **Back** to return to Single Loop Display without saving the new setpoint.

Selecting Manual, Automatic, or Tune Control

Press **Man/Auto**.

- If you set the output mode to **Auto**, the MLS automatically controls the process according to the configuration information you give it.
- If you set the output mode to **Manual**, you need to set the output level.
- If you set the output mode to **Tune**, you can tune the PID parameters.

If the Loop is in Manual Mode

- Press **Yes** to toggle the mode.
- Press **No** to skip the mode change menu and set the output level. (See the **Manual Output Levels** section for instructions.)
- Press **Back** to return to the single loop display without saving the new mode setting.
- Press **Enter** to save your changes and return to single loop display.

If the loop is in Automatic Mode

- Press **Yes** to toggle the mode.
- Press **Back** or **No** to return to single loop display without saving your changes.
- Press **Enter** to save your changes and if you have selected Manual Mode, set the output level. (To learn how to set the output level, see **Manual Output Levels**.)

- Press **Enter**, then **Back** to store the new mode and return to Single Loop Display without setting an output level.



NOTE

If the loop outputs are disabled, you cannot toggle between Manual and Automatic output control. If you try it, the screen shows an error message telling you that the outputs are disabled, as shown below.

Use the menus in the Setup Loop Outputs main menu to enable the outputs. (See Chapter 4: Setup for more information about the Setup menus.)



Setting the Manual Output Levels

You'll only see this menu if you set the current loop to Manual control. Use this menu to set the manual heat and cool output levels. (The cool output level menu will only be present if the cool output for the current loop is enabled; see **Outputs Enabled/Disabled** in *Chapter 4: Setup*). You should see a display like this:



- Press **Yes** to change the output power level. (If the MLS' heat outputs are enabled, you will be able to change the heat output power level. If only the cool outputs are enabled, you will be able to change only the cool output power level.)
- Then press **Yes** or **No** to select a new output power level.
- When you are satisfied with the power level you have chosen, press **Enter** to store your changes.
- Then press **No** to advance to the cool output menu (if the cool outputs on the MLS are enabled).
- Press **Back** at any time to discard your changes and return to single loop display.

Automatically Tuning a Loop

When you use the Autotune function, the controller automatically sets the loop to Manual control, 100% output. (If you selected a continuous output limit, the controller sets the loop to the output limit.) The autotune function calculates the appropriate PID constants for the loop and puts the loop in automatic control with the calculated PID values.

The Autotune function will abort if:

- The process variable goes over 75% of the setpoint. (Remember, the controller is at 100% output or at the output limit you set.)
- The controller has not calculated PID constants after 10 minutes (due to heater failure, sensor failure, etc.).

If the autotune function aborts, it puts the loop into its previous control state (Automatic or Manual control) at the previous output percentages.

To automatically tune a loop, follow these steps:

1. Make sure the process is cold (or stable and well below setpoint).
2. Initiate Autotune:

1. Use the front panel keypad to go to Single Loop Display.
2. Press the **Man/Auto** key.
3. Choose Tune.
4. Press **Enter**.

The Tune indicator will flash and the controller will return to Single Loop Display. The Tune indicator will flash as long as the loop is tuning.

Setup

The Setup menus let you change the MLS' detailed configuration information.

If you have not set up a Modular Loop System before, or if you don't know what values to enter, please read first the next chapter, *Tuning and Control* which contains PID tuning constants and useful starting values.

How to enter the Setup menus?

1. In Single Loop Display, select the loop you wish to edit.
2. While still in Single Loop Display, enter the pass sequence below:
Press **Enter**, **Alarm Ack**, **Change Setpoint**.



3. The first setup menu appears.



NOTE

For your protection, MLS reverts to Single Loop Display if you don't make any changes for three minutes.

How to edit a menu?

- Press **Yes** to select this menu or **No** to advance to the next menu.
- Press **Yes** or **No** to toggle between the options in your menu.
- Press **Enter** to store the value you have selected.
- If you decide not to edit the menu, press **Back** to stop editing and return to the main menu.

In the next sections you will find detailed information about the submenus for each of the six main menus.

Each display contains the default value for that specific menu, and below each display you will see the range of choices for that menu.

The next page shows a diagram describing the six main menus and all the submenus in each one of them.

Setup Global Parameters?	Setup Loop xx Input?	Setup Loop xx Control Params?	Setup loop xx Outputs?	Setup Loop xx Alarms?	Manual I/O Test?
save setup to job?	Input type?	Heat control PB?	Heat control out?	High process alarm setpoint?	Digital inputs?
Load setup from job?	Pulse sample time?	Heat control TI?	Heat output type?	High process alarm type?	Keypad test?
Job control dig inputs?	Loop name?	Heat control TD?	Heat output cycle time? (TP)	High process alarm dig out?	Test digital output?
Job digital input true?	Input units?	Heat control filter?	SDAC menus (SDAC)	Deviation alarm value?	Digital output number?
Output override dig input?	Input reading offset (T/C & RTD)?	Cool control PB?	Heat output action?	High deviation alarm type?	
Override dig in active?	Disp format (Linear & Pulse)?	Cool control TI?	Heat output limit?	Alarm dig out?	
Startup alarm delay?	Input scaling Hi pv? (Linear & Pulse)	Cool control TD?	Heat output limit time?	Low deviation alarm type?	
Keyboard lock status?	Input scaling Hi rdg? (Linear & Pulse)	Cool control filter?	Sensor fail Ht output?	Low deviation alarm dig out?	
Power up output status?	Input scaling Lo pv? (Linear & Pulse)	Heat/Cool spread?	Outputs heat NLO?	Low process alarm setpoint?	
Controller address?	Input scaling Lo RDG? (Linear & Pulse)		Cool control out?	Low process alarm type?	
Communications err check?	Lo pass filter value?		Cool output type?	Low process alarm dig out?	
Communications baud rate?			Cool output cycle time?	Alarm dead-band?	
Allen Bradley protocol?			SDAC menus (SDAC)	Alarm delay?	
AC line freq?			Cool output action?		
Digout outputs active?			Cool output limit?		
AIM comm. failure output?			Cool output limit time?		
EPROM information			Sensor fail Cl output?		
			Outputs cool NLO?		

Press **Enter, Alarm Ack, Change Setpoint** to reach these menus.
 Press **Yes** to use a menu.
 Press **Up** or **Down** to change a value or select an option.
 Press **Enter** to store the value you have changed.
 Press **Back** to escape a menu without changing it.

Setup Global Parameters Menu

The setup global parameters menu looks like this

LOOP	PROCESS	UNITS
SETUP GLOBAL PARAMETERS?		
ALARM SETPOINT	STATUS	OUT%

Below is the setup global parameters menu tree. Notice the default values inside the boxes.:

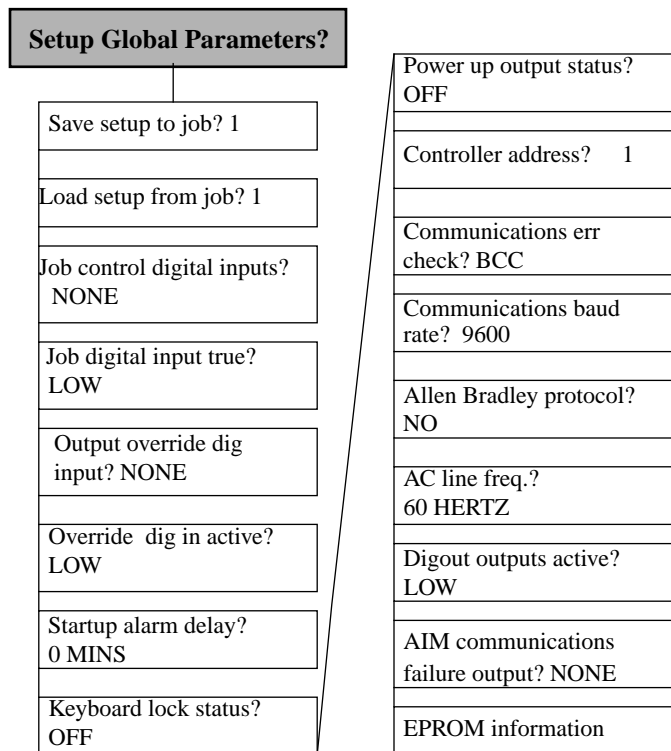

Save to Job

Use this menu to save the job information for every loop to one of eight jobs in the MLS' battery-backed RAM.

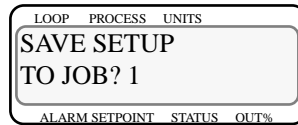

Selectable Range: 1-8.

If you have enabled the remote job control function, you will not be able to save a job; when you try to do it, you will see this message:



Load from Job

Use this menu to load any one of eight saved jobs from the controller's front panel.

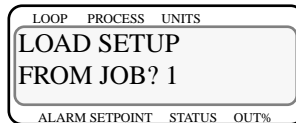

Selectable values: The last job number or job 1.

The following parameters are loaded as part of a job:

1. PID constants, filter settings, setpoints, and spread values.
2. Loop control status (Automatic or Manual), and output values (If the loop is in Manual control).
3. Alarm functions (Off, Alarm, Control), setpoints, high/low process setpoints, high/low deviation setpoints and deadband settings, and loop alarm delay.

If you have enabled the remote job control function, this menu is **disabled**.

Job Select Inputs

Use the Remote Job Control feature to run up to 8 jobs remotely. The Job Select Inputs menu is the third menu under Setup Global Parameters. It lets you set the number of job select inputs. The controller uses these inputs as a binary code that specifies the job number to run. The number of inputs you choose in this menu controls the number of jobs you can select remotely. The menu looks like this:



Selectable values: 1, 2, 3 , or NONE.

Below is the truth table that tells you which input states select which jobs.

Digital Input 3	Digital Input 2	Digital Input 1	Job #
F	F	F	1
F	F	T	2
F	T	F	3
F	T	T	4
T	F	F	5
T	F	T	6
T	T	F	7
T	T	T	8

You can choose 1, 2, or 3 inputs, or None. These choices have the following effect:

Setting	Enables
1 input	Jobs 1-2
2 inputs	Jobs 1-4
3 inputs	Jobs 1-8
None (no inputs)	Remote Select disabled

Job Digital Input Polarity

Use this menu to set the polarity of the digital outputs used for job selection. You can set the Active state to closed (Low) or open (High).



Selectable values: Low or High.

Output Override Digital Input

This menu lets you set a digital input that sets all loops in manual output at output levels you select in the **Outputs** menu. This menu, and the next one, let you configure a "panic button" or "kill switch" that sets all outputs to the output override percentage you set in the **Setup Loop Outputs** main menu.



Selectable values: Input number 1-8, or NONE.



WARNING

ANAFAZE recommends that you install additional external safety devices or over-temperature devices for emergency shutdowns. Do not rely solely on the output override feature to shut down your process.

Output Override Input Polarity

This menu lets you toggle the polarity of the Output Override digital input. You can set the input to be active when Low or active when High.



Selectable values: Low or High.

Startup Alarm Delay

Use this menu to set a startup delay for process and deviation alarms for all loops. The controller does not report these alarm conditions for the specified number of minutes after the controller powers up. (The controller will always report failed sensor alarms, no matter what startup delay you set.)

LOOP	PROCESS	UNITS
STARTUP ALARM DELAY? 0 mins		
ALARM SETPOINT	STATUS	OUT%

Selectable Range: 0-60 minutes.

Keyboard Lock Status

Use this menu to lock the front panel operator function keys Change SP, Man/Auto, and Ramp/Soak so that pressing these keys has no effect. If you want to use these functions, turn off the Keyboard Lock.

LOOP	PROCESS	UNITS
KEYBOARD LOCK STATUS? OFF		
ALARM SETPOINT	STATUS	OUT%

Selectable values: On or Off.

Power-Up Output Status

Use this menu to set the initial power-up state of the control outputs to Off or Memory. If you choose Off, all control outputs are initially set to Manual mode at 0% output level. If you choose Memory, the outputs are restored to the last output state stored in memory.

LOOP	PROCESS	UNITS
POWER UP OUTPUT STATUS? OFF		
ALARM SETPOINT	STATUS	OUT%

Selectable values: Off or Memory.



WARNING

Do not set the MLS to start from memory if a memory-based restart is unsafe for your process.

Controller Address

Use this menu to set the MLS controller address. The controller address is used for multiple controller communications on a single RS-485 cable, so each MLS must have a different address. Begin with address 1 for the first controller and assign each subsequent controller the next higher address.

LOOP	PROCESS	UNITS
CONTROLLER		
ADDRESS? 1		
ALARM SETPOINT	STATUS	OUT%

Selectable Range: a number between 1 and 32.

Communications Error Checking

Use this menu to set the data check algorithm used in the ANAFAZE communications protocol to Block Check Character (BCC) or to Cyclic Redundancy Check (CRC).

CRC is a more secure error checking algorithm than BCC, but it requires more calculation time and slows the MLS communications. BCC ensures a high degree of communications integrity, so ANAFAZE recommends that you use BCC unless your application specifically requires CRC.

LOOP	PROCESS	UNITS
COMMUNICATIONS		
ERR CHECK? BCC		
ALARM SETPOINT	STATUS	OUT%

Selectable values: BCC or CRC.



NOTE

If you are using ANASOFT, be sure to configure ANAINSTL for the same error checking method that you set in this menu.

Communications Baud Rate

Use this menu to set the Communications Baud Rate to 2400 or 9600 baud.

LOOP	PROCESS	UNITS
COMMUNICATIONS		
BAUD RATE? 9600		
ALARM SETPOINT	STATUS	OUT%

Selectable values: 9600 or 2400.



NOTE

If you use ANASOFT, be sure to set ANAINSTL to the same baud rate that you set in this menu.

Allen Bradley Protocol

Use this menu to set the protocol type to either Allen Bradley or ANAFAZE.

LOOP	PROCESS	UNITS
ALLEN BRADLEY		
PROTOCOL? NO		
ALARM SETPOINT	STATUS	OUT%

Selectable values: Yes or No.

AC Line Frequency

Use this menu to configure the controller to match an AC line frequency of 50 or 60 Hz. (This function is provided for international users who require 50 Hz lines.) Since the controller reduces the effect of power line noise on the analog measurement by integrating the signal over the period of the AC line frequency, the controller's noise rejection will suffer if the line frequency is not set correctly.

LOOP	PROCESS	UNITS
AC LINE FREQ ?		
60 HERTZ		
ALARM SETPOINT	STATUS	OUT%

Selectable values: 60 Hz or 50 Hz.



NOTE

If you change the AC line frequency, you must switch power to the MLS on and off for the change to take effect.

Digital Output Polarity

Use this menu to set the polarity of the digital outputs used for alarms. The output can be active High or active Low.

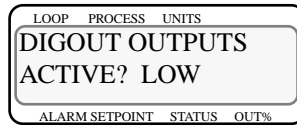

Selectable values: High or Low.

AIM Communications Failure Output

Use this menu to select the digital output that activates if communications fail between the MLS-AIM and the MLS-PM. You can use this output, along with the Global Alarm output, to power an alarm horn or buzzer that sounds if communications fail between the AIM and the PM.

The global alarm will activate if there is an AIM communications failure, and will reset automatically when the problem is corrected. The controller will revert to manual mode during an AIM communications failure.



Selectable values: any output from 1 to 34 as long as it's not used for control or for SDAC clock, or NONE.

EPROM Information

Use this last menu of the Setup Global Parameters main menu to see the controller's EPROM version and checksum.

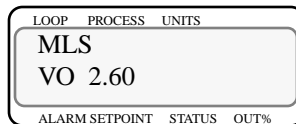

Press any key from this menu to return to the Setup Parameters menu.

Setup Loop Input

The Setup Loop Input main menu lets you access menus which change loop input parameters:

- Input type
- Input scaling and calibration
- Input filtering

The next section explains how to configure inputs via the front panel.



Below is the menu tree for the Setup Loop Inputs menu. Notice the default values inside the boxes.

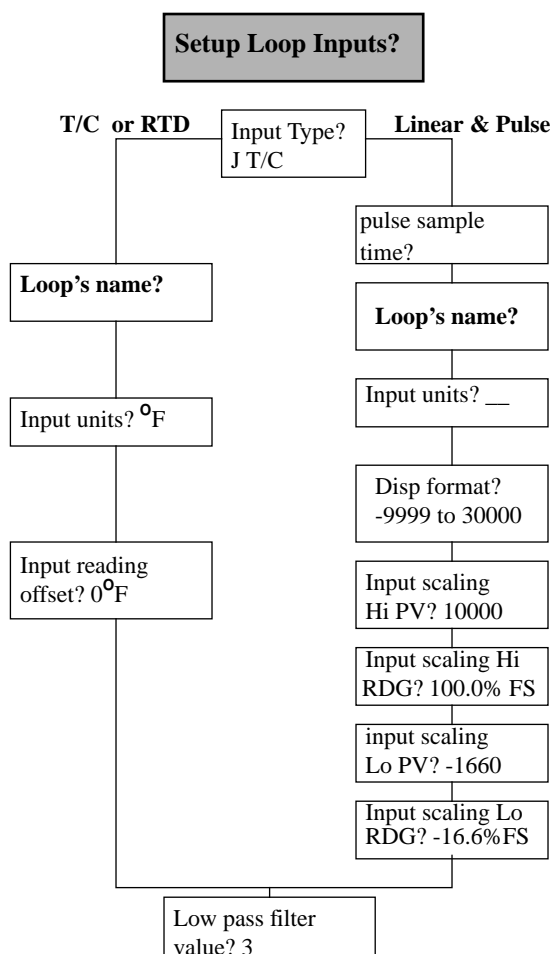

Input Type

Use this menu to configure the input sensor for each loop as one of these input types:

- Thermocouple types (J, K, T, S, R and B).
- RTD. Three ranges: RTD1 (Platinum Class A), RTD2 (Platinum Class B), and RTD3 (Nickel).
- Linear and Pulse inputs.
- Skip (an input type available for unused channels.) The scanning display doesn't show loops you've set to Skip.

LOOP	PROCESS	UNITS
06	INPUT TYPE?	
	J T/C	
ALARM SETPOINT	STATUS	OUT%

The next table shows the MLS' input types and ranges.

Input Type	Fahrenheit Range	Celsius Range
J	-350 to +1400	-212 to +760
K	-450 to +2500	-268 to +1371
T	-450 to +750	-268 to +399
S	0 to +3200	-18 to +1760
R	0 to +3210	-18 to +1766
B	+150 to +3200	+66 to +1760
RTD1	-148.0 to +572.0	-100.0 to +300.0
RTD2	-184 to +1544	-120 to +840
RTD3	-94 to 572	-70 to 300
Pulse	0-2 KHz	
Skip	Loop is not scanned or displayed.	
Linear	see the <i>Linear Scaling section</i> (this chapter) and <i>Appendix</i> .	

Pulse Sample Time

You can connect a digital pulse signal of up to 2 KHz to the controller's pulse input. Use this menu to specify the pulse sample period. Every sample period, the number of pulses the controller receives is divided by the sample time. The controller scales this number and uses it as the pulse loop's PV.

LOOP	PROCESS	UNITS
06	INPUT PULSE	
	SAMPLE TIME?	1s
ALARM SETPOINT	STATUS	OUT%

Selectable range: 1-20 seconds.

Loop Name

Use this menu to name your loop. You can choose any two characters from the set of characters used for the input units. (See table below).

LOOP	PROCESS	UNITS
A5	LOOP SAM- PLE NAME?	A5
ALARM SETPOINT	STATUS	OUT%

Input Units

Use this menu to choose a three-character description of the loop's engineering units.

LOOP	PROCESS	UNITS
06	INPUT UNITS?	° F
ALARM SETPOINT	STATUS	OUT%

Selectable values: This table shows the character set for input units.

Input	Character Sets for Units
thermocouples & RTDs	F or C degrees
Linear and Pulse	0-9, A-Z, %, degrees, /, space

Input Reading Offset

Use this menu to make up for the input signal's inaccuracy. For example, at temperatures below 400 °F, a type J thermocouple may be inaccurate ("offset") by several degrees F. Use an independent thermocouple or your own calibration equipment to find the offset for your equipment. To correct for offset errors, change the factory default setting to a positive or negative value for the loop you are editing. (A positive value increases the reading and a negative value decreases it.)

LOOP	PROCESS	UNITS
06	INPUT READING	
OFFSET? 0 ° F		
ALARM SETPOINT	STATUS	OUT%

Selectable range: -300 to +300.



NOTE

If the input type is Linear, Pulse, or Skip, you will not see the Input Reading Offset menu.

Linear Scaling Menus

The linear scaling menus appear under the Setup Loop Inputs main menu, and they are available for Linear and Pulse inputs only. It lets you scale the "raw" input readings (readings in millivolts or hertz) to the engineering units of the process variable.

You'll only see the linear scaling menus if you set the loop's input type to Linear or Pulse.

For linear inputs, the input reading is in percent (-16.6 to 100%) representing the -10-60 mV input range of the MLS. The scaling function is defined by two points on a conversion line. It relates the high PV to the high reading and the low PV to the low reading to define the line. The engineering units of the process variable can be any arbitrary units.

The graph below shows pressure as an example.

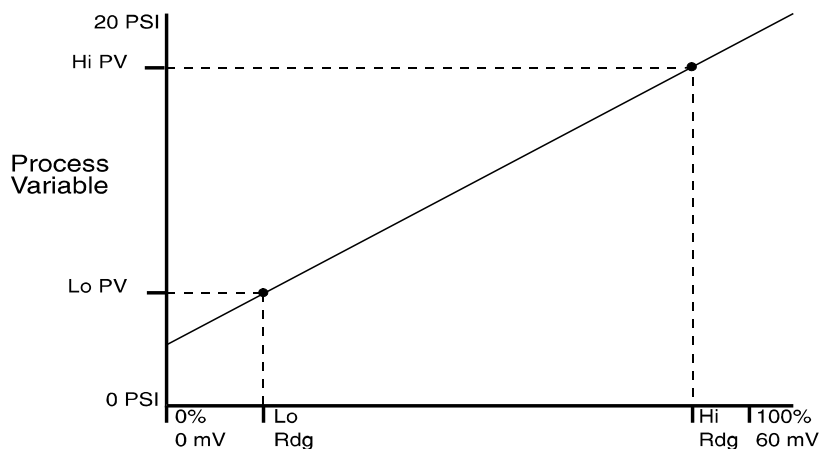

Before you enter the values that determine the two points for the conversion line, you must choose an appropriate display format. The MLS has six characters available for process variable display; select the setting with the desired number of decimal places before and after the decimal point. Use a display format that matches the range and resolution of the process variable. The display format you choose is used for the setpoint, alarms, deadband, spread, and proportional band.

The PV (Process Variable) range for the scaled input is between the PV values that correspond to the -16.6% and 100% input readings. This PV range defines the limits for the setpoint and alarms, as shown here.

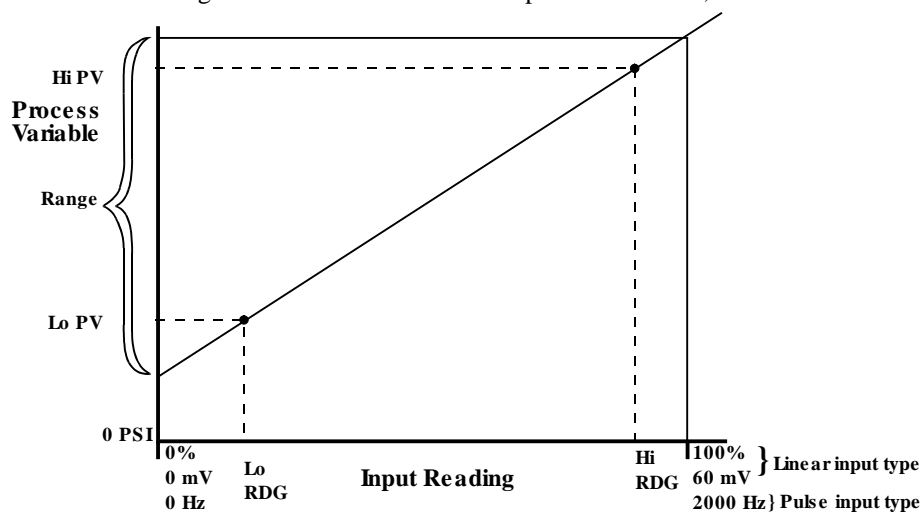

NOTE

See *Linear Scaling Examples* section in this manual.

Display Format

Use this menu to select a display format for a linear input. Choose a format appropriate for your input range and accuracy.

LOOP	PROCESS	UNITS
05 DISP FORMAT		
-9999 TO 30000		
ALARM SETPOINT	STATUS	OUT%

Selectable values: The MLS has several available display formats, as shown below. this table shows also the high and low PV values. .

Display Formats	High PV Default	Low PV Default
-9999 to +30000	10000	0
-999 to +3000	1000	0
-99 to +300	100	0
-9 to +30	10	0
-.9999 to +3.0000	1.0000	.0000
-9.999 to +30.000	10.000	.000
-99.99 to +300.00	100.00	.00
-999.9 to +3000.0	1000.0	.0

High Process Value

Use this menu to enter a high process value. The high process value and the high reading value together define one of the points on the linear scaling function's conversion line.

LOOP	PROCESS	UNITS
01 INPUT SCALING		
HI PV? 10000 °F		
ALARM SETPOINT	STATUS	OUT%

Selectable values: See table above.

High Reading

Use this menu to enter the input level that corresponds to the high process value you entered in the previous menu. For linear inputs, the high reading is a percentage of the full scale input range. For pulse inputs, the high reading is expressed in Hz.

The 100% full scale input value is 60 mV for the linear input type.

LOOP	PROCESS	UNITS
09	INPUT SCALING	
HI RDG = 100.0% FS		
ALARM SETPOINT	STATUS	OUT%

Selectable range: Any value between -99.9 and 110.0. For pulse input, the range is 0-2000 Hz, and the default is 1000 Hz.

Low Process Value

Use this menu to set a low process value for input scaling purposes. The low process value and the low reading value together define one of the points on the linear scaling function's conversion line.

LOOP	PROCESS	UNITS
02	INPUT SCALING	
LO PV? 0 ° F		
ALARM SETPOINT	STATUS	OUT%

Selectable values: See table on previous page.

Low Reading

Use this menu to enter the input level that corresponds to the low process value you selected in the previous menu. For linear inputs, the low reading is a percentage of the full scale input range. For pulse inputs, the low reading is expressed in Hz.

LOOP	PROCESS	UNITS
12	INPUT SCALING	
LO RDG ? .-16.6%FS		
ALARM SETPOINT	STATUS	OUT%

The full scale input range for the linear input type is -10 to 60 mV, which corresponds to -16.6 to 100.0%.

Selectable range: Any value between - 99.9 and 110.0. For pulse inputs, the range is 0-2000 Hz, and the default is 0.

Input Filter

Access this menu from the Setup Loop Inputs main menu. The MLS has two different types of input filter:

- A noise rejection filter that rejects high frequency input signal noise. This filter keeps a "trend log" of input readings. If a reading is outside the filter's "acceptance band", and later readings are within the acceptance band, the MLS ignores the anomalous reading. (The acceptance band for thermocouples is 5 degrees above and 5 degrees below the input reading. For linear inputs, it's 0.5% above and 0.5% below the input reading.) If later readings are also outside the acceptance band, the MLS accepts the anomalous reading and calculates a new acceptance band. (This input filter does not require adjustment.)
- A standard resistor-capacitor (RC) filter that lets you dampen the input response if inputs change unrealistically or change faster than the system can respond. If the input filter is enabled, the process variable responds to a step change by going to 2/3 of the actual value within the number of scans you set.

If all input loops are enabled (none of them are set to SKIP) the MLS scans each input loop 2 times per second. The input filter applies to all input types except those set to SKIP.

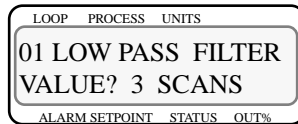

Selectable range: 0-255 scans.

Setup Loop Control Parameters

Use these menus to change control parameters for heat and cool outputs of the selected loop, including:

- Proportional Band (PB), Integral (TI or Reset), and Derivative (TD or Rate) settings.
- Output Filter.
- Spread between heat and cool outputs.

The Setup Loop Control Parameters menu looks like this:

LOOP	PROCESS	UNITS
SETUP LOOP 01		
CONTROL PARAMS?		
ALARM	SETPOINT	STATUS OUT%



NOTE

Both heat and cool outputs have the same menus, so only one of each menu is explained in the text. The controller shows both heat and cool menus even if the heat or cool output is disabled. (See *Setup Loop Outputs* for help in enabling or disabling the heat or cool output.)

Refer to *Tuning and Control* section for help in selecting control parameter values.

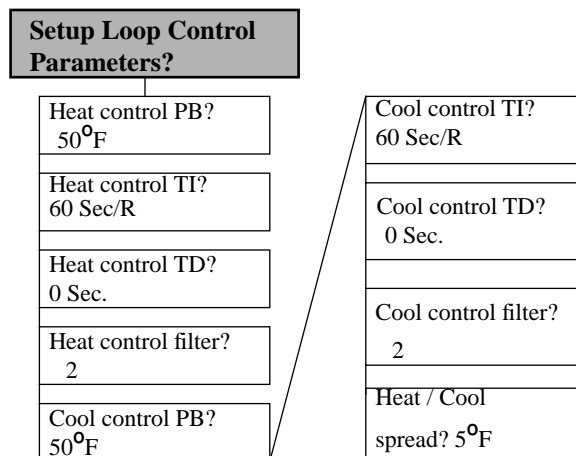

Heat/Cool Control PB

Use this menu to set the Proportional Band.

LOOP	PROCESS	UNITS
01	HEAT CONTROL	
PB? 50 °F		
ALARM SETPOINT	STATUS	OUT%



NOTE

The MLS internally represents the proportional band (PB) as a gain value. When you edit the PB, you'll see the values change in predefined steps--small steps for narrow PB values and large steps for wide PB values.

The controller calculates the default PB for each input type according to the following equation:

$$\text{Default PB} = \frac{(\text{High Range} - \text{Low Range})}{\text{Gain}}$$

Heat/Cool Control TI

Use this menu to set the Integral term, or Reset.

LOOP	PROCESS	UNITS
01	HEAT CONTROL	
TI ? 180 SEC/R		
ALARM SETPOINT	STATUS	OUT%

Selectable range: 0-6000 seconds.

Heat/Cool Control TD

Use this menu to set the derivative constant.

LOOP	PROCESS	UNITS
15	HEAT CONTROL	
TD ? 0 SEC		
ALARM SETPOINT	STATUS	OUT%

Selectable range: 0-255 seconds.

Heat/Cool Output Filter

Use this menu to dampen the heat or cool output's response. The output responds to a step change by going to approximately 2/3 of its final value within the number of scans you set here.

LOOP	PROCESS	UNITS
07	HEAT CONTROL	
FILTER ? 2		
ALARM SETPOINT	STATUS	OUT%

Selectable range: 0-255. Setting the output filter to 0 turns it off.

Heat/Cool Spread

Use this menu to set the spread between the heat and cool output and the spread of the On/Off control action.

LOOP	PROCESS	UNITS
01	HEAT	
SPREAD ? 5 °F		
ALARM SETPOINT	STATUS	OUT%

Selectable range: The spread ranges from 0 to 255, 25.5, 2.55, .255 or .0255, depending on the way you set up the input menus.

Setup Loop Outputs

Press **Yes** at this prompt to access menus to change loop output parameters for the current loop, including:

- Enable or disable outputs
- Output type
- Cycle time (for TP outputs)
- SDAC parameters (for SDAC outputs)
- Control action
- Output level limit and limit time
- Output override
- Nonlinear output curve

Both heat and cool outputs have the same menus, so only one of each menu is explained in this section. (The next page shows a menu tree.)

Here's the main menu:



The figure on the next page shows the menu tree for the output setup menus. Notice the default values inside the boxes

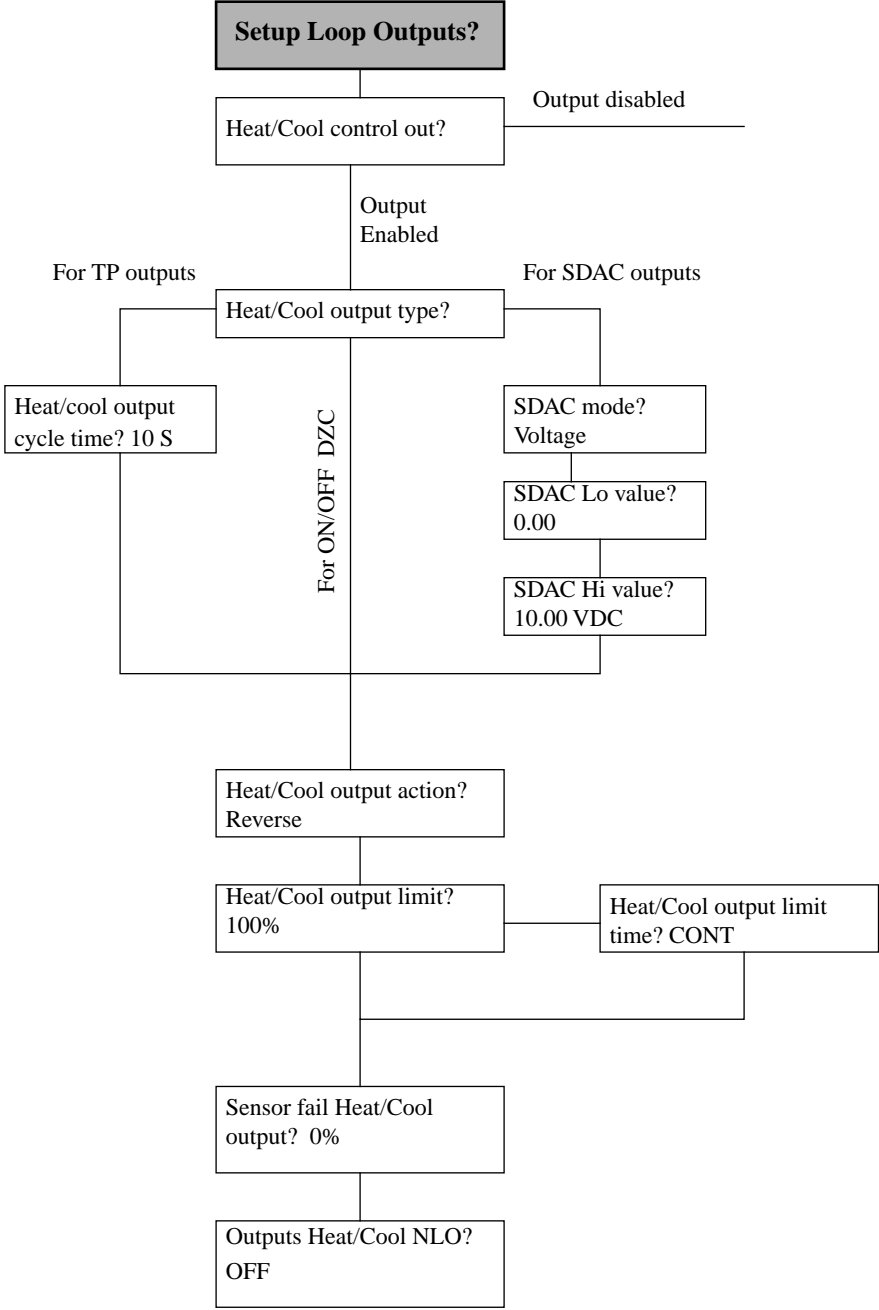

Enable/Disable Heat and Cool Outputs

Use this menu to enable or disable the heat or cool output for the current loop. If you want the loop to have PID control, you must enable one output. You can also disable a heat or cool control output and use the output pin for something else, like an alarm.



Selectable values: Enabled or Disabled. The default setting enables the heat outputs and disables the Cool outputs.

Heat or Cool Output Type

Use this menu to set the output type. .

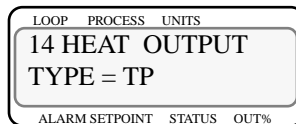

The next table shows the available output types.

Display Code	Output Type	Definition
TP	Time Proportioning	Percent output converted to a percent duty cycle over the programmed cycle time.
DZC	Distributed Zero Crossing	Output on/off state calculated for every AC line cycle.
SDAC	Serial DAC	Output type for optional Serial Digital-Analog Converter (SCAC)
ON/OFF	On / Off	Output either full ON or full OFF.

For an expanded description of these output types, see *Tuning and Control*.

Heat/Cool Cycle Time

Use this menu to set the Cycle Time for Time Proportioning outputs.

LOOP	PROCESS	UNITS
03	HEAT OUTPUT	
CYCLE TIME ? 10S		
ALARM SETPOINT	STATUS	OUT%

Selectable range: 1-255 seconds.



NOTE

The Cycle Time menu will only be present if the output type for the current loop is Time Proportioning.

SDAC Menus

If you attach the optional SDAC to an output, you must configure that output for the SDAC using the following series of menus. The MLS will also assign digital output #34 as a clock line for the SDAC. You won't be able to assign another function to output #34 while any loop's output is set to SDAC.

SDAC Mode

Use this menu to toggle the SDAC between current and voltage output. The SDAC menus only appear if the output type for the loop is set to SDAC.

LOOP	PROCESS	UNITS
01	SDAC MODE ?	
VOLTAGE		
ALARM SETPOINT	STATUS	OUT%

Selectable values: Current and Voltage.

SDAC High Value

Use this menu to set a high value for the SDAC output. Set the high and low value to match the range of the output device. For instance, if the output device has a 4-20 mA range, set the SDAC high value to 20.00 mA and the SDAC low value to 4.00 mA. The controller converts 0% output to a 4.00 mA signal and 100% output to a 20.00 mA signal.

LOOP	PROCESS	UNITS
03	SDAC HI VALUE ?	
	10.00	VDC
ALARM SETPOINT	STATUS	OUT%

Selectable values: If the output is set to Voltage, the default high value is 10.00 volts. If the output is set to Current, the default high value is 20.00 mA. You cannot set the high value to be less than or equal to the low value.

SDAC Low Value

Use this menu to set a low value for the SDAC output. Set the high and low value to match the range of the output device. For instance, if the output device has a 0.00-10.00 Vdc range, set the SDAC high value to 10.00 Vdc and the SDAC low value to 0.00 Vdc. The controller converts 0% output to a 0.00 Vdc signal and 100% output to a 10.00 Vdc signal.

LOOP	PROCESS	UNITS
04	SDAC LO VALUE ?	
	0.00	VDC
ALARM SETPOINT	STATUS	OUT%

Selectable values: If the output is set to Voltage, the default low value is 0.00 volts. If the output is set to Current, the default value is 4.00 mA. You cannot set the low value to be greater than or equal to the high value.

Heat/Cool Output Action

Use this menu to select the control action for the current output loop. Normally, heat outputs are set to reverse action and cool outputs are set to direct action.

LOOP	PROCESS	UNITS
01	HEAT OUTPUT ACTION ?	REVERSE
ALARM SETPOINT	STATUS	OUT%

Selectable values: Reverse or Direct.
For Heat outputs, set to Reverse; for Cool outputs, set to Direct.

Heat/Cool Output Limit

Use this menu to limit the maximum PID control output for a loop's heat and cool outputs. This limit may be continuous, or it may be in effect for a specified number of seconds (see **Output Limit Time** on the next page). If you choose a timed limit, the output limit restarts when the controller powers up and when the output goes from Manual to Automatic control (via the front panel, when the controller changes jobs, or from ANASOFT.) The output limit only affects loops under automatic control. It does not affect loops under manual control.

LOOP	PROCESS	UNITS
01	HEAT OUTPUT	
LIMIT ? 100%		
ALARM SETPOINT	STATUS	OUT%

Selectable range: 0-100%

Heat/Cool Output Limit Time

Use this menu to set a time limit for the output limit.

LOOP	PROCESS	UNITS
04	HEAT OUTPUT	
LIMIT TIME ? CONT		
ALARM SETPOINT	STATUS	OUT%

Selectable values: 1-999 seconds, or CONT (continuous).

Heat/Cool Output Override

Use this menu to set an output override percentage. (You can configure a digital input for the output override in the Setup Global Parameters main menu.) If the current loop is in Automatic mode and a sensor failure occurs, the loop switches to the output override percentage, manual mode. If you change the polarity of the override output to the active state--for instance, by flipping a "kill switch" you have set up--every loop switches to the output override percentage you set here.

LOOP	PROCESS	UNITS
03	SENSOR FAIL	
HT OUTPUT ? 0%		
ALARM SETPOINT	STATUS	OUT%

Selectable range: 0-100%

Heat/Cool Nonlinear Output Curve

Use this menu to select one of two nonlinear output curves for nonlinear processes.



Selectable values: Curve 1, Curve 2, or Off (linear/no curve).

The linear curves are shown in the figure below. Calculated by PID

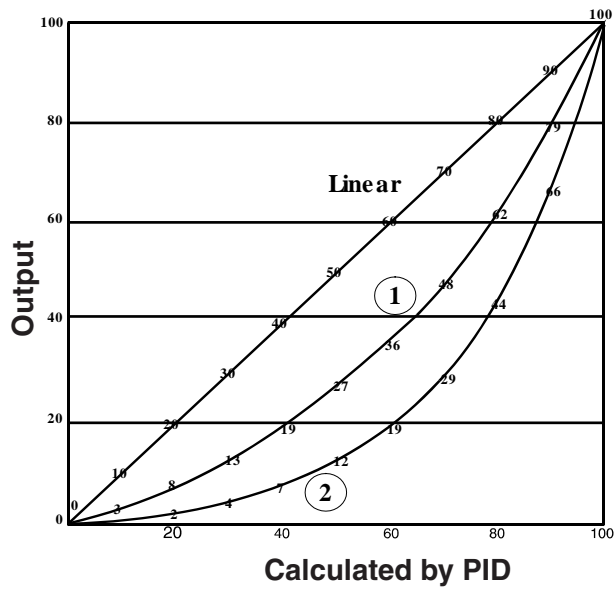

Setup Loop Alarms

Press **Yes** at the Setup Loop Alarms prompt to access menus which change alarm function parameters for the current loop. The main alarms menu looks like this:

LOOP	PROCESS	UNITS
SETUP LOOP 04		
ALARMS ?		
ALARM SETPOINT	STATUS	OUT%

Below is the alarms menu tree. Notice the default values inside the boxes.

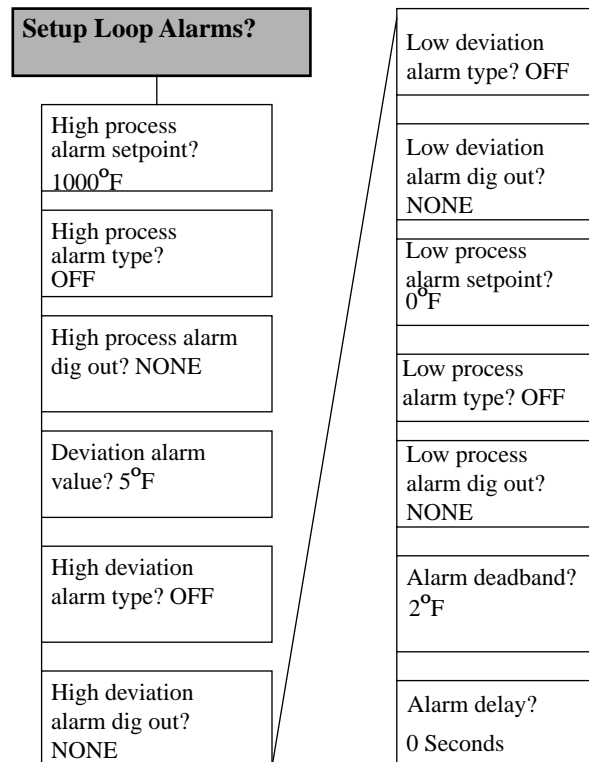

Alarm Types

The MLS has three different kinds of alarms: failed sensor alarms, global alarms, and process alarms.

Failed Sensor Alarms

Failed sensor alarms alert you to T/C breaks and these RTD open or short failures:

- Open + or - input.
- Short between + and - input.

When the loop is in Automatic or Tune mode and a failed sensor alarm occurs, the MLS sets the loop to Manual control at the failed sensor percentage you set in the Setup Loop Outputs menus.

Global Alarms

Global alarms occur when a loop alarm, set to Alarm (not Control), is unacknowledged, or when there are any unacknowledged failed sensor alarms. (If an alarm occurs, the MLS front panel displays an appropriate alarm code--see *Chapter 4: Using the MLS* for an explanation of these codes.) Even if the alarm condition goes away, the global alarm stays on until you use the **Alarm Ack** key (or ANASOFT) to acknowledge it.

Process Alarms

Process alarms include high and low deviation and high and low process alarms. You can set each of these alarms to Off, Alarm, or Control, as shown here.

Function	Description
Off	No alarm or control function
Alarm	Standard alarm function
Control	Normal alarm function, except that you don't have to acknowledge alarms

- High process and high deviation alarms activate when the process variable goes above a value you set. They remain active until the process variable goes below that value minus the deadband. (See the diagram on the next page.)
- If you don't use a digital output for PID control, you can assign it to one or more process variable alarms. The output is active if any of its alarms are active. All alarm outputs are active Low or active High, depending on the global alarm output polarity setting.
- Low process and low deviation alarms activate when the process variable goes below a value you set. They remain active until the process variable goes above that value plus the deadband. (The diagram below shows these alarms.)

When the controller powers up or the setpoint changes, deviation alarms do not activate until the process goes inside the deviation alarm band--preventing deviation alarms during a cold start. (High and low process alarms are always enabled.)

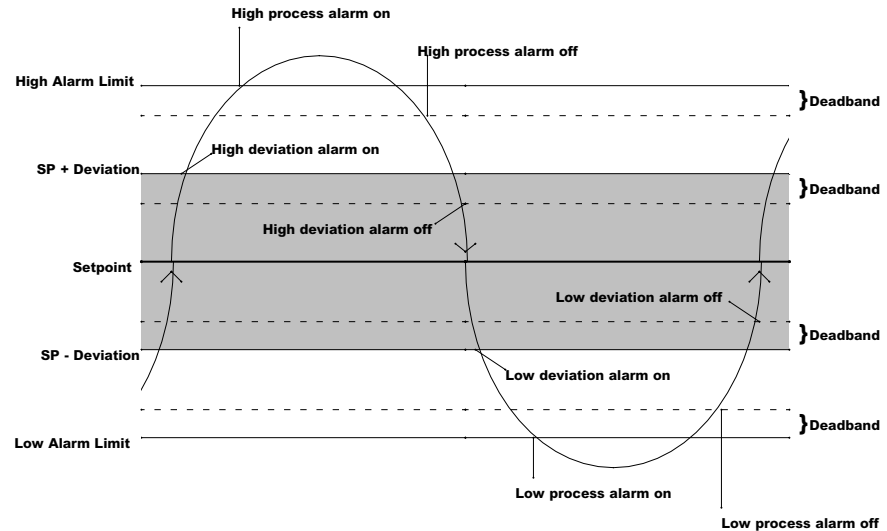

Use menus to set the following process alarm parameters for each loop:

- High and low process alarm type, setpoint, and digital output.
- High and low deviation alarm type, deviation alarm value, and alarm digital output.
- Alarm deadband.
- Loop alarm delay.

The setpoints, deviation alarm values, and deadband all use the same decimal format as the loop's process variable.

Alarm Delay

You can set the MLS to delay normal alarm detection and alarm reporting. There are two kinds of alarm delay:

- The startup alarm delay delays process alarms (but not failed sensor alarms) for all loops for a time period you set in the **Setup Global Parameters** main menu.
- The loop alarm delay delays failed sensor alarms and process alarms for one loop until the alarm condition is continuously present for longer than the loop alarm delay time you set.



NOTE

Failed sensor alarms are affected by the loop alarm delay even during the startup alarm delay time period.

High Process Alarm Setpoint

Use this menu to select the setpoint (temperature or other value within the scaled sensor range) at which the high process alarm activates. The high process alarm activates when the process variable (PV) goes above the high process setpoint. It deactivates when the PV goes below the high process setpoint minus the deadband value, if you have set a deadband value.

LOOP	PROCESS	UNITS
04 HI PROC ALARM		
SETPT ? 1000 °F		
ALARM SETPOINT	STATUS	OUT%

Selectable range: Any point within the scaled sensor range.

High Process Alarm Type

Use this menu to turn off the high process alarm or set it to the alarm or control function.

LOOP	PROCESS	UNITS
01 HI PROC ALARM		
TYPE ? OFF		
ALARM SETPOINT	STATUS	OUT%

Selectable values: Alarm, Control, Off.

High Process Alarm Output Number

Use this menu to choose the digital output that activates when the loop is in high process alarm. You can use this output to activate a second alarm horn or buzzer. You can also use it to control your process. For example, you can set the output you have chosen to activate heating or cooling mechanisms, or to turn off the system.

LOOP	PROCESS	UNITS
01 HI PROC ALARM		
DIG OUT ? NONE		
ALARM SETPOINT	STATUS	OUT%

Selectable values: Any output number between 1 and 34, as long as it's not already used for control or the SDAC clock. You may also select NONE.



NOTE

All digital outputs are "OR'ed" together (combined). Therefore you can assign more than one alarm to the same output number, and that output will be On if any of those alarms is On.

Deviation Band Value

Use this menu to set the deviation bandwidth, a positive and negative alarm or control point relative to the setpoint. If the setpoint changes, the alarm or control points also change. You can assign a separate digital output to the high and low deviation alarm/control setpoints- so that, for example, a high deviation alarm turns on a fan and a low deviation alarm turns on a heater.

LOOP	PROCESS	UNITS
02 DEVIATION ALARM		
VALUE ? 5°F		
ALARM SETPOINT	STATUS	OUT%

Selectable values: You can set a value from 0 to 255, 25.5, 2.55, .255 or .0255, depending on how you set up the input menus.

High Deviation Alarm Type

Use this menu to disable the high deviation alarm function or set it to the alarm or control function. (The high deviation alarm activates if the process value (PV) rises above the deviation band value, and remains active until the PV goes below the deviation band value minus the deadband value.)

LOOP	PROCESS	UNITS
07 HI DEVIATION		
ALARM TYPE ? OFF		
ALARM SETPOINT	STATUS	OUT%

Selectable values: Alarm, Control, Off.

High Deviation Alarm Output Number

Use this menu to assign a digital output which activates when the loop is in high deviation alarm. The digital output only activates if you have set the high deviation alarm type to Alarm or Control.

LOOP	PROCESS	UNITS
01	HI DEV ALARM	DIG OUT ? NONE
ALARM SETPOINT	STATUS	OUT%



NOTE

All digital outputs are "OR'ed" together (combined). Therefore you can assign more than one alarm to the same output number, and that output will be On if any of those alarms is On.

Selectable range: Any output number between 1 and 34, as long as it isn't used for control or the SDAC clock. You may also select NONE.

Low Deviation Alarm Type

Use this menu to turn Off the low deviation alarm or set it to Alarm or Control mode.

LOOP	PROCESS	UNITS
12	LO DEVIATION	ALARM TYPE ? OFF
ALARM SETPOINT	STATUS	OUT%

Selectable values: Alarm, Control, Off.

Low Deviation Alarm Output Number

Use this menu to assign a digital output that activates when the loop is in low deviation alarm.

LOOP	PROCESS	UNITS
12	LO DEV ALARM	DIG OUT? NONE
ALARM SETPOINT	STATUS	OUT%

Selectable values: Any output number between 1 and 34, as long as it isn't used for control or the SDAC clock. You may also select NONE.



NOTE

All digital outputs are "OR'ed" together (combined). Therefore you can assign more than one alarm to the same output number, and that output will be On if any of those alarms is On.

Low Process Alarm Setpoint

Use this menu to set a low process alarm setpoint. (The low process alarm activates when the process variable goes below the low process alarm setpoint. It deactivates when the process variable goes above the low process alarm setpoint plus the deadband.)

LOOP	PROCESS	UNITS
01	LO PROC ALARM	
SETPT ? 0 °F		
ALARM SETPOINT	STATUS	OUT%

Selectable range: Any value within the input sensor's range.

Low Process Alarm Type

Use this menu to turn off the low process alarm or set it to the Alarm or Control function.

LOOP	PROCESS	UNITS
01	LO PROC ALARM	
TYPE ? OFF		
ALARM SETPOINT	STATUS	OUT%

Selectable values: Alarm, Control, Off.

Low Process Alarm Output Number

Use this menu to assign the digital output that activates when the loop is in low process alarm.

LOOP	PROCESS	UNITS
04	LO PROC ALARM	
DIG OUT ? 31		
ALARM SETPOINT	STATUS	OUT%

Selectable values: Any output number between 1 and 34, as long as it isn't used for control or the SDAC clock. You may also select NONE.



NOTE

All digital outputs are "OR'ed" together (combined). Therefore you can assign more than one alarm to the same output number, and that output will be On if any of those alarms is On.

Alarm Deadband

Use this menu to set an alarm deadband. This deadband value applies to the high process, low process, high deviation, and low deviation alarms for the loop you are editing. Use the Alarm Deadband to avoid repeated alarms as the PV cycles slightly around an alarm value.

LOOP	PROCESS	UNITS
03	ALARM	
DEADBAND ? 2 °F		
ALARM SETPOINT	STATUS	OUT%

Selectable values: The default range is 0 to 255, 25.5, 2.55, .255, or .0255, depending on how you set up the input menus.

Loop Alarm Delay

Use this menu to set a loop alarm delay. There are two types of alarm delay: the startup alarm delay and loop alarm delay. Startup alarm delay (which you can set in the **Setup Global Parameters** main menu) delays process alarms (but not failed sensor alarms) for all loops for a specified time after the controller powers up.

The loop alarm delay, in contrast, is set separately for each loop. It delays failed sensor and process alarms until the alarm condition has been continuously present for longer than the alarm delay time. (Failed sensor alarms are not subject to the startup alarm delay, but they are affected by the loop's alarm delay during the startup alarm delay period.)

LOOP	PROCESS	UNITS
04	ALARM DELAY ?	
0 SECONDS		
ALARM SETPOINT	STATUS	OUT%

Selectable range: 0-255 seconds.

Manual I/O Test

Press **Yes** at this prompt to see menus which can help you test the digital inputs, digital outputs and the MLS' keypad.



The next figure shows the I/O Test menu tree. Notice the default values inside the boxes.

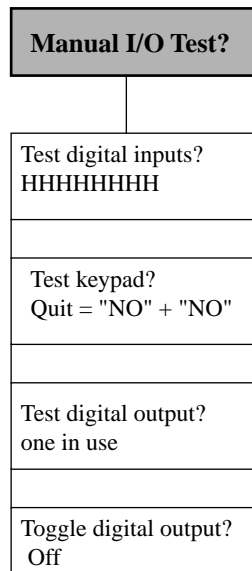

Digital Input Testing

Use this menu to view the logic state of the 8 digital inputs as H (High--the input is at 5 volts or is not connected) or L (Low--the input is at zero volts). The menu displays inputs 1 to 8 from left to right. Since inputs are pulled High when they are not connected, test an input by shorting it to controller common and making sure this menu shows the correct state for that input.



Using This Menu

- Short the digital input you are testing to controller common. When you do that, the input's state should change to L.
- Press **Yes** or **No** to advance to the next menu.
- Press **Back** to return to the Manual I/O test main menu.

Keypad Test

Use this menu to test the keypad.

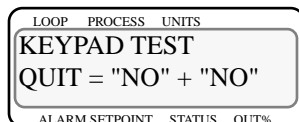

Using This Menu

- Press any key to test the keypad. The MLS will display the name of the key you have pressed.
- Press **No** twice to advance to the next menu.

Test Digital Output

Use this menu to select one of the digital alarm outputs to test in the next menu.



Toggle Digital Output

Use this menu to manually toggle a digital output On or Off to test it. (You select the output to test in the previous menu.) On may be Low or High depending on the digital output polarity you set in the Output Polarity menu. (All outputs are set to Off when you exit Manual I/O Test menu.)

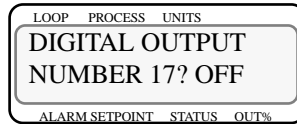

Selectable values: On or Off.

Tuning and Control

Introduction

This chapter explains PID control and supplies some starting PID values and tuning instructions, so that you can use control parameters appropriate for your system. If you would like more information on PID control, consult the ANAFAZE *Practical Guide to PID*.

The control mode dictates how the controller responds to an input signal. The control mode is different from the type of control output signal (like analog or pulsed DC voltage). There are several control modes available: On/Off, Proportional (P), Proportional and Integral (PI), Proportional with Derivative, and Proportional with Integral and Derivative (PID). P, PI, or PID control are necessary when process variable (PV) cycling is unacceptable or if the process or setpoint (SP) is variable.



NOTE

For any of these control modes to function, the loop must be in Automatic mode.

Control Modes

The next sections explain the different modes you can use to control a loop.

On/Off Control

On/Off control is the simplest way to control a process; a controller using On/Off control turns an output on or off when the process variable reaches a certain limit above or below the desired setpoint. You can adjust this limit, since ANAFAZE's controllers use an adjustable spread. For example, if your setpoint is 1000 °F, and your limit (spread) is 20 °F, the output switches On when the process variable goes below 980 °F and Off when the process goes above 1000 °F.

The next diagram shows a process under On/Off control.

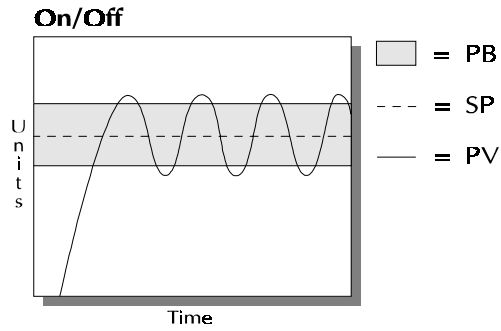

Proportional Control

A process using On/Off control frequently cycles around the setpoint. When process variable cycling is unacceptable or the process or setpoint are variable, use proportional control. Proportional control, or Gain, eliminates cycling by increasing or decreasing the output proportional to the process variable's distance from the setpoint.

The limits of proportional control are defined by the Proportional Band (PB); outside this band of control, the output is either 100% or 0%. For example--using the same values from the example above and a PB of 20°--the output is:

- 50% when the process variable is 990 °F
- 75% when the process variable is 985 °F
- 100% when the process variable is 980 °F or below.

However, a process which uses only Proportional control may settle at a point above or below the setpoint; it may never reach the setpoint at all. This behavior is known as "offset" or "droop".

This diagram shows a process under proportional control only.

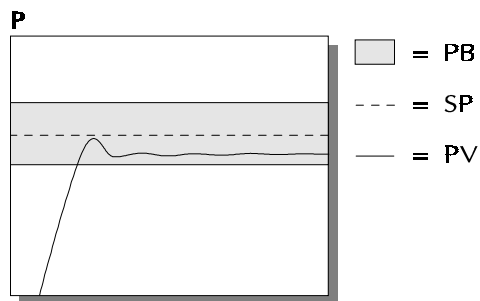

Proportional and Integral Control

For Proportional and Integral control, use the Integral term, or Reset, with Proportional control. The Integral term corrects for offset by repeating the Proportional band's error correction until there is no error. For example, if a process tends to settle about 5 °F below the setpoint, use Integral control to bring it to the desired setting.

The next diagram shows a process under proportional and integral control.

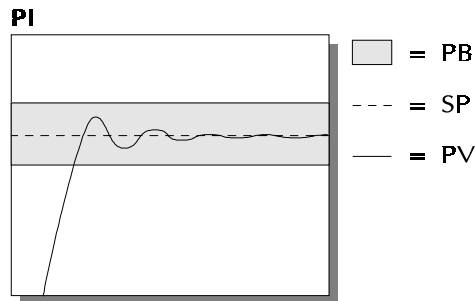

Proportional, Integral and Derivative Control

For an improved level of control, use Derivative control with Proportional or Proportional and Integral control. Derivative control, also called the Rate function, corrects for overshoot by anticipating the behavior of the process variable and adjusting the output appropriately. For example, if the process variable is rapidly approaching the setpoint, Derivative control reduces the output, anticipating that the process variable will reach setpoint. Use it to eliminate the process variable overshoot common to PI control.

This figure shows a process under full PID (Proportional, Integral, and Derivative) control.

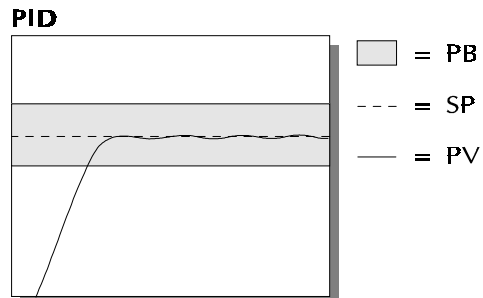

Digital Output Control Forms

The next section explains different modes for control outputs.

On/Off

On/Off output is very simple: it turns the output on or off according to the control signal of the On/Off control.

Time Proportioning (TP)

Time Proportioning attempts to digitally simulate an analog output percentage by turning the output On or Off for each time step, so that the cumulative average of the output is the desired setting. You must enter a cycle time for TP outputs. The cycle time is the time over which the output is proportioned, and it can be any value from 1 to 255 seconds. For example, if the output is 30% and the Cycle Time is 10 seconds, then the output will be on for 3 seconds and off for 7. The figure below shows typical TP and DZC graphs.

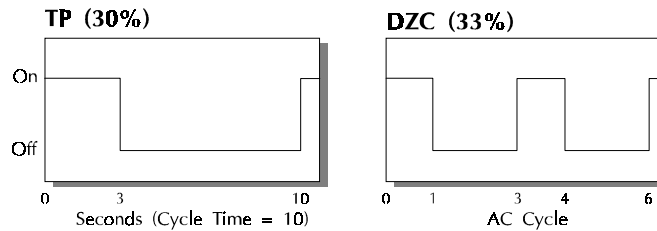

Distributed Zero Crossing (DZC)

DZC output is essentially a Time Proportioning output. However, for each AC line cycle the controller decides whether the power should be On or Off. There is no Cycle Time since the decision is made for each line cycle. Since the time period for 60 Hz power is 16.6 ms, the switching interval is very short and the power is applied uniformly. Switching is done only at the zero crossing of the AC line, which helps reduce electrical “noise”.

DZC output is primarily used for very fast acting electrical heating loads using Solid State Relays (SSRs). For instance, the open air heater coil is an example of a fast acting load. Do not use DZC output for electromechanical relays.

The combination of DZC output and a solid state relay can inexpensively approach the effect of analog phase angle fired control.

Analog Outputs

The Serial DAC is an optional analog output module for the CLS. It lets the controller output precision analog voltages or currents--typically for precision open-loop control, motor or belt speed control, or phase angle fired control. To use it, set the output type for the appropriate loop to SDAC.

ANAFAZE also offers the DAC, another optional analog output module for the MLS. It converts two DZC outputs to two 4-20 mA current outputs.

Output Digital Filter

The output filter digitally filters the PID control output signal. It has a range of 0-255 levels, which gives a time constant of 0-127.5 seconds. Use the output filter if you need to filter out erratic output swings due to extremely sensitive input signals, like a turbine flow signal or an open air thermocouple in a dry air gas oven.

The output filter can also enhance PID control. Some processes are very sensitive and require a high PB, so normal control methods are ineffective. You can use a smaller PB- and get better control- if you use the digital filter to reduce the high and low process output swings.

You can also use the filter to reduce output noise when a large derivative is necessary, or to make badly tuned PID loops and poorly designed processes behave properly.

Reverse and Direct Action

Reverse action is an output control action in which an increase in the process variable causes a decrease in the output. Direct action is an output control action in which an increase in the process variable causes an increase in the output. Heating applications normally use reverse action and cooling applications usually use direct action.

Setting Up and Tuning PID Loops

To start your process after installation, tune the control loops and set them to automatic control. If the loop is already in automatic control mode and controlling the process, set the loop to manual control. Then you can tune it without upsetting the process. However, if you don't mind minor process fluctuations, you can tune the loop in automatic control mode.



NOTE

Remember that tuning is a slow process. After you change a PID parameter, allow time (20 minutes for most processes) before you make another change.

Proportional Band (PB) Settings

This table shows PB settings for several setpoints.

Temperature Setpoint	PB	Temperature Setpoint	PB	Temperature Setpoint	PB
-100 to 99	20	1100 to 1199	75	2200 to 2299	135
100 to 199	20	1200 to 1299	80	2300 to 2399	140
200 to 299	30	1300 to 1399	85	2400 to 2499	145
300 to 399	35	1400 to 1499	90	2500 to 2599	150
400 to 499	40	1500 to 1599	95	2600 to 2699	155
500 to 599	45	1600 to 1699	100	2700 to 2799	160
600 to 699	50	1700 to 1799	105	2800 to 2899	165
700 to 799	55	1800 to 1899	110	2900 to 2999	170
800 to 899	60	1900 to 1999	120	3000 to 3099	175
900 to 999	65	2000 to 2099	125	3100 to 3199	180
1000 to 1099	70	2100 to 2199	130	3200 to 3299	185

Setting the PB: a General Rule

Set the PB to 10% of the setpoint below 1000^o and 5% of the setpoint above 1000^o. This setting is useful as a starting value.

Integral Term (TI) Settings

This table shows Integral vs. Reset repeats per minute.

TI (secs./repeat)	Reset (repeats/min)	TI (secs./repeat)	Reset (repeats/min)
30	2.0	210	0.28
45	1.3	240	.25
60	1.0	270	.22
90	.66	300	.20
120	.50	400	.15
150	.40	500	.12
180	.33	600	.10

Setting the TI: A General Rule

Use 60, 120, 180, or 240 as a starting value for the TI.

Derivative Term (TD) Settings

This table shows Derivative term (TD) vs. Rate Minutes (RM);
Rate=TD/60.

TD (secs./repeat)	Rate (repeats/min)	TD (secs./repeat)	Rate (repeats/min)
5	.08	35	.58
10	.16	40	.66
15	.25	45	.75
20	.33	50	.83
25	.41	55	.91
30	.50	60	1.0

Setting the TD: A General Rule

Set the TD to 15% of TI as a starting value.

General PID Constants

This section gives general PID constants.

Proportional Band Only (P)

Set the PB to 7% of the setpoint

Example: Setpoint = 450, set the Proportional Band to 31.

Proportional with Integral (PI)

Set the PB to 10% of setpoint.

Example: Setpoint = 450, set PB to 45.

Set TI to 60.
Set TD to Off.
Set the Output Filter to 2.

PI with Derivative (PID)

Set the PB to 10% of the SP.

Set the TI to 60.

Set the TD to 15% of the TI. **Example:** TI = 60, so TD = 9).

Set the Output Filter to 2.

	PB	TI	TD	FIL	OUTPUT	CT	Action
Electric heat with solid state relays	50	60	15	4	TP	3	Reverse
Electric heat with mechanical relays	50	60	15	6	TP	20	Reverse
Gas heat with motorized valves	60	120	25	8	DZC/DAC	NA	Reverse
Gas heat with motorized valves (SP > 1200° F)	100	240	40	8	DZC/DAC	NA	Reverse
Extruders with cooling, Heat with SSRs	50	300	90	8	TP	3	Reverse
Spread set to zero, cool with solenoid valve	10	OFF	OFF	4	TP	20	Direct
Cool with fans	10	OFF	OFF	4	TP	60	Direct
Electric heat with open heat coils	30	20	OFF	4	DZC	NA	Reverse
Electric heat with SCR controllers	60	60	15	4	DZC/DAC	NA	Reverse

Troubleshooting

The next few sections describe general troubleshooting for the MLS. Later sections describe specific procedures, like checking an input, changing the EPROM, and testing the controller.

First, Check your Installation

The controller is only part of your control system. Often, what appears to be a problem with the MLS is really a problem with other equipment, so check these things first:

- Controller is installed correctly. (See *Chapter 2: Installation* for help.)
- Inputs, like thermocouples and RTDs, are installed correctly with correct scaling resistors, and working correctly.

Second, Replace Unit



WARNING

Check the installation before you replace the controller! If the controller wasn't installed correctly, for instance, if you have shorted sensor inputs to high voltage lines or a transformer is shorted out, and you replace the MLS with a spare unit, the spare unit will break, and you'll need to send both units to ANAFAZE for repair.

If you are certain that the controller is installed correctly, you can try replacing the MLS with a spare controller -- one module at a time. If the spare unit works correctly, then the problem is specific to the MLS you replaced.

If you need to update the MLS Erasable Programmable Read-Only Memory (EPROM), please refer to the third section, Changing the EPROM.

Manual Controller Reset

If the instructions in this chapter tell you to perform a "manual controller reset" (also called a "No Key Reset"), follow these instructions:

- Disconnect power to the unit.
- Press and hold the No key on the MLS front panel. Reconnect power to the unit.



WARNING

A manual controller reset clears the MLS memory and resets its parameters to their default values. If you reset a stand-alone system, you cannot recover your original parameters. If you have a computer supervised system, ANASOFT stores a copy of your parameters.

Do not attempt to repair the MLS yourself. There are no user-repairable components in the MLS. If the troubleshooting procedures in this chapter do not solve your system's problems, you will need to return the unit to ANAFAZE for testing and repair, see *Returning the Unit to ANAFAZE* below.

Returning your Unit to ANAFAZE

If you need to return the MLS to ANAFAZE, please call ANAFAZE for a Returned Materials Authorization (RMA) number. The RMA number helps us track your equipment and return it to you as soon as possible.

Try to figure out if the problem is in the MLS-PM or the MLS-AIM, and send only that part for repair.

Troubleshooting Stand-Alone Systems

The MLS is self contained, so there are very few things you can test if it is not functioning properly. However, the MLS is only part of a control system; check other parts of the system, like thermocouples, before you assume that the unit is broken.

You may assume that there is a problem if:

- The LEDs on the Analog Input Module (AIM) are not blinking.
- The MLS Processor Module's LCD screen is not lit.
- The LCD screen does not display graphics or characters.

The rest of this section describes common problems and solutions for stand-alone systems.

MLS-PM Has No Power

If you supply power to the MLS-PM and the LCD screen does not light up, check the power supply and its connections. Follow the instructions in the *Power Wiring and Controller Test* section of the *Installation* chapter.

Keys Don't Respond

If the MLS seems to function perfectly, but the **Man/Auto**, **Chng SP**, **Alarm Ack**, and **Ramp/Soak** keys do not respond when you press them, then you are probably locked out of the system. Ask your supervisor to unlock the keyboard according to the instructions in the *Setup Global Parameters* section.

Controller Message: AIM Comm Failure

If you power up the MLS-PM and the message AIM COMM FAIL appears, or if the LED on the AIM is not blinking, check the following:

- Make sure power supply connections are correct (see the *Power Wiring and Controller Test* section of the *Installation* chapter).
- Make sure the AIM Communications cable is plugged into the AIM and the connector labeled "TO AIM" on the MLS-PM.

If the AIM COMM FAIL message still appears, perform a manual controller reset. If the MLS still does not power up with the Bar Graph Display, return the unit to ANAFAZE for repair.

Checking Analog Inputs

If the number of inputs recognized by the MLS-PM does not agree with the number of inputs in the MLS-AIM, perform a manual controller reset with the AIM connected to the processor module. If the numbers still don't agree, check the following:

Make sure the input wires are properly connected. Every input on the MLS-AIM has three screw terminals: positive, negative, and auxiliary. All T/C, milliamp, and voltage inputs connect to the positive and negative terminals. RTD inputs connect to all three terminals.

Check for high common mode voltage. It is not uncommon for heaters to leak into the T/C wires. Use an AC Voltmeter for testing.

If the inputs are not reading properly, make sure you have selected the correct input type from the Setup menus (see *Chapter 4: Setup*).

Checking the Operation of an Input

- Disconnect the sensor wiring.
- Set the input sensor to type J T/C from the Setup menus.
- Place a short across the input.

The process variable should indicate ambient temperature. If it does not, call ANAFAZE for an RMA number and return the unit for repair.

If the process variable indicates ambient temperature, then the MLS is working correctly and the problem lies in the sensor or sensor wiring. You can test T/C or RTD sensors with a Multimeter.

- To check thermocouple inputs, unplug the AIM module and measure between the A+ and A- terminals of the AIM-TB. Thermocouple inputs should not read above 200 ohms.
- To check RTD inputs, unplug the AIM module and measure between the A+ and A- terminals. Then measure between the A+ and A COM terminals of the AIM-TB. RTD inputs should read between 20 and 250 ohms. Both readings should be the same.

Make sure other inputs operate within the AIM's full scale voltage (60 mVdc). If they do not, install scaling resistors on the MLS-AIM-TB (see *Chapter 2: Installation*).

Checking PID Control Outputs

To check control outputs:

- Set the loop you want to check to Manual mode.
- Set the output power percentage to the desired level.
- Set the output type to On/Off or TP (see *Chapter 4: Setup*).

Testing Control Output Devices

To test a control output device like an SSR, use a digital multimeter set to DC voltage. Connect the positive lead of the multimeter to the MLS +5V and the negative lead to the control output. The multimeter should read 0 Vdc when the output is 0% and +5 Vdc when the output is 100%.

If the control output is not connected to an output device like an SSR, connect an LED in series with a 1K resistor from +5 V to the output. (Tie the anode of the LED to +5V.) The LED should be Off when the output is 0% and On when the output is 100%.

Checking Digital I/O

You can check digital inputs and outputs from the Setup menus (see *Chapter 4: Setup*) or you can use the techniques described above for PID control outputs.

Checking Computer Supervised Systems

These four elements must work properly in a computer-supervised system:

- The MLS.
- The computer and its RS-232 or RS-485 serial interface.
- The RS-232 or RS-485 communication lines.
- The computer software.

For MLS troubleshooting, disconnect the communications line from the computer and follow the troubleshooting steps in the first section of this chapter. The next few sections explain troubleshooting for the other elements of computer supervised systems.

Computer Problems

If you suspect computer problems, run ANASOFT in Edit mode to find out if the computer works correctly. (See the *ANASOFT User's Guide* for a description of correct operation.)

- If ANASOFT tells you that your computer is not functioning, contact your computer service representative.
- Check your ANAINSTL program to make sure that ANASOFT and the MLS are set for the same serial communications port. ANASOFT can use either COM1 or COM2.
- Make sure that you have set the same error checking method--either BCC or CRC--in ANASOFT and in the processor module.
- Check that the communications baud rate is also set to the same value--either 2400 or 9600--in ANASOFT and in the processor module.
- Make sure you are using DOS 5.0 or a later version of DOS.

Serial Interface Problems

Set the serial interface according to the manufacturer's instructions. To test an RS-232 interface, buy an RS-232 troubleshooter from Radio Shack. Attach the troubleshooter between the MLS and the computer. When ANASOFT sends data to the MLS, the troubleshooter's TX LED should blink. When it receives data from the MLS, the RX LED should blink.

If you use the Black Box RS-485 interface, make sure you have set it up correctly. (See the Communications section in Chapter 2 for RS-485 setup instructions.) The LEDs on the unit should blink, but should not stay lit. For either type of interface, you can connect an oscilloscope to the transmit or receive line to see whether data is being sent or received. If the serial interface does not function, contact your computer service representative.

Communications Problems

If you are experiencing communications problems, check the communications interface, cables, and connections.



NOTE

Most communications problems are due to incorrect wiring or improper communications parameters. Therefore, check the wiring and communications parameters before you check anything else.

If your system has multiple MLS or other control units, you must use RS-485 communications. Therefore, the internal RS-232/RS-485 selection jumper must be set to the correct position.

From the setup menus, make sure that the communications parameters (address, error checking and baud rate) are set correctly for each MLS in your system. Every controller must have a separate address, starting with 1 and increasing by 1 for each controller. After you assign the controller addresses, you must configure ANAINSTL with the same parameters.

In multiple controller systems, ANASOFT indicates which controllers are communicating and which are not. If you power down a controller in a multiple-controller system, ANASOFT should indicate a COMM FAILURE in that unit. Disable communications to that unit until you power it up again.

Ground Loops

During installation, sometimes the MLS-PM common wire is tied to earth ground, and the computer's RS-232 common wire is tied to earth ground. This arrangement creates a ground loop which may affect communications and other MLS functions. To avoid ground loops, either use an optically isolated communications adapter or disconnect the MLS from earth ground and tie an 0.1 microfarad capacitor from MLS DC common to earth ground.

Software Problems

This section gives some solutions for software problems.

User-Written Software

If you don't want to use ANASOFT as your software interface to the MLS, you are responsible for the correct operation of the software you buy or write. You can request the ANAFAZE *Communications Specification* if you want to write your own software. ANAFAZE will answer any technical questions that arise during your software development process, but ANAFAZE does not otherwise support user software in any way.

If you write your own software, first write a routine that sends and receives display commands to and from the MLS. The protocol includes all characters, so the display should show the hexadecimal values of the data sent in both directions. If you have problems with the software you write, you can use this program to test your communications.

ANASOFT

If ANASOFT is not working, check these things first:

- **ANAINSTL (the ANASOFT installation program) has the correct path for the program and data files.**
- **All the necessary files exist in the directory specified by the path.**
- **Your computer has enough memory.** ANASOFT requires up to 640K of free memory to run. To maximize the amount of free memory available, use a memory manager (like HIMEM from DOS 5.0).
- **Your computer is not running memory-resident programs.** Check your AUTOEXEC.BAT file to make sure that no memory resident programs automatically run on startup; they may interfere with ANASOFT.
- **The software key is properly installed on the printer port.** It should plug into the printer port with the female end toward the computer and the male end toward the printer. Do not remove the screws on the software key to connect it.

If, after you check these things, ANASOFT still does not work correctly, consult the *ANASOFT User's Guide* for more troubleshooting information.

Changing the EPROM

Changing the EPROM involves minor mechanical disassembly and reassembly of the controller, but you don't need any soldering or electrical expertise. You'll need a Phillips head screwdriver and a small flathead screwdriver.



NOTE

If you change the EPROM, you must perform a manual controller reset for the EPROM change to take effect. A manual controller reset changes all controller parameters back to their default values, so you must reenter the desired values from ANA-SOFT or from the controller's front panel after you change the EPROM.

1. Power down the controller. Be sure to take antistatic precautions.
2. Remove the two or four screws from the sides of the controller front panel and remove the two screws from the top of the case, as shown below.

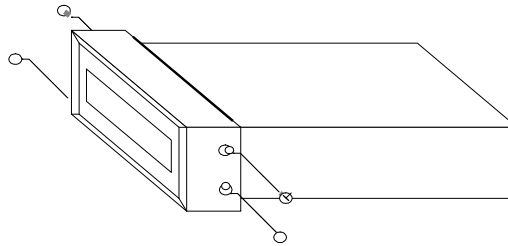

3. Remove the electronics assembly from the case, as shown below.

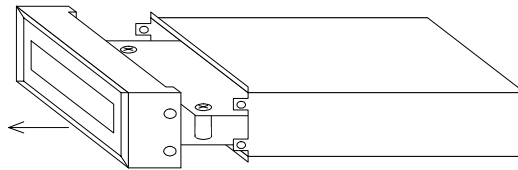

4. Unscrew the four screws at the corners of the top board and carefully unplug this board to access the bottom board (processor board). The next figure shows the screws to remove:

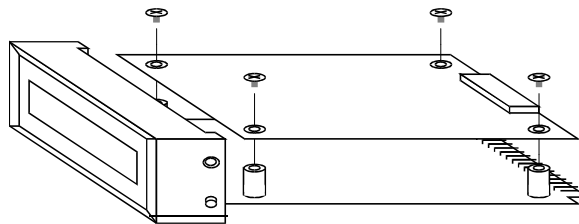

5. Locate the EPROM on the circuit board. The EPROM is a 28-pin socketed chip which may have an ANAFAZE label on top of it. If there is no label, a small window will be visible in the middle of the top of the chip.

Do not confuse the EPROM with the RAM; the RAM also has 28 pins, but it is in a high-profile socket, and it does not have a label or a window. (The component designation U2 is printed on the processor board next to the EPROM socket.)

The next figure shows the EPROM and the RAM chip..

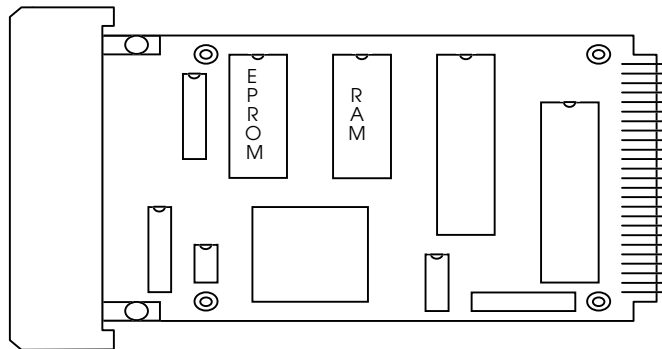

6. Remove the existing EPROM from its socket by prying it out with a small flathead screwdriver, as shown below.

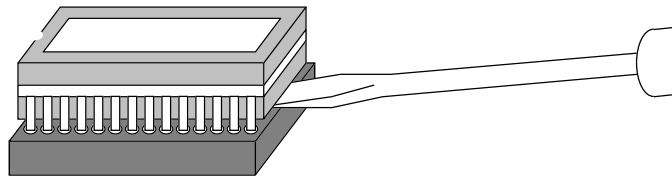

7. Carefully bend the legs of the new EPROM against a flat surface until they line up with the holes in the EPROM socket.
8. Carefully insert the new EPROM into the EPROM socket. Make sure that the chip is oriented so that its notch faces the same way as the part outline on the board.
9. Reverse steps 2 through 4 to reassemble the unit.
10. Perform a manual controller reset. The reset reinitializes the battery backed RAM. You must perform a manual controller reset for the unit to operate properly.

Linear Scaling Examples

Example 1: Configuring a Pressure Sensor

You're using a pressure sensor that generates a 4-20 milliamp signal. The sensor generates 4 milliamps at 0.0 PSI and 20 mA at 50.0 PSI.

Setup

You connect the sensor to a loop input set up with a resistor scaling network to produce 60 millivolts at 20 mA. (See the **Inputs** section of *Chapter 2: Installation* for more information on scaling networks.)

The sensor measures PSI in tenths, so the appropriate display format is -999.9 to +3000.0.

This table shows the input readings.

PV Displayed	Sensor Input	Reading (%FS)
50.0 PSI	20	100%
0.0 PSI	4	$100\% \times (4\text{ma}/20\text{ ma}) = 20\%$

Based on these input readings, use these scaling values:

Parameter	Low Value	High Value
Process Value (PV)	0.0 PSI	50.0 PSI
Input Reading (RDG)	20.0	100.0

Example 2: Configuring a Flow Sensor

You connect a flow sensor to the MLS to measure the flow in a pipe. The sensor generates a 0-5V signal. The sensor's output depends on its installation. Measurements of the flow in the pipe indicate that the sensor generates 0.5 volts at three gallons per minute (GPM) and 4.75 volts at 65 GPM. The calibration instruments are precise to ± 1 gallon per minute.

Setup

The sensor is connected to a loop input set up with a resistor voltage divider network to produce 60 millivolts at 5 volts. (See the **Inputs** section of the *Installation* chapter for information on scaling networks.)

The calibrating instrument is precise to ± 1 gallon per minute, so the appropriate display format is -999 to +3000.

This table shows the input readings.

PV Displayed	Sensor Input	Reading (%FS)
65 GPM	4.75	$(4.75V / 5.00V) \times 100\% = 95\%$
3 GPM	0.5	$(0.5V / 5.00V) \times 100\% = 10\%$

Based on these input readings, use these scaling values:

Parameter	Low Value	High Value
Process Value (PV)	3 GPM	65 GPM
Input Reading (RDG)	10.0	95.0

Glossary

A

AC

See Alternating Current.

AC Line Frequency

The frequency of the AC power line measured in Hertz (Hz), usually 50 or 60 Hz.

Accuracy

Closeness between the value indicated by a measuring instrument and a physical constant or known standards.

Action

The response of an output when the process variable is changed. See also Direct action, Reverse action.

Address

A numerical identifier for a controller when used in computer communications.

Alarm

A signal that indicates that the process has exceeded or fallen below a certain range around the setpoint. For example, an alarm may indicate that a process is too hot or too cold. See also:

- Deviation Alarm
- Failed Sensor Alarm
- Global Alarm
- High Deviation Alarm
- High Process Alarm
- Loop Alarm
- Low Deviation Alarm
- Low Process Alarm

Alarm Delay

The lag time before an alarm is activated.

Alternating Current (AC)

An electric current that reverses at regular intervals, and alternates positive and negative values.

Ambient Temperature

The temperature of the air or other medium that

surrounds the components of a thermal system.

American Wire Gauge (AWG)

A standard of the dimensional characteristics of wire used to conduct electrical current or signals. AWG is identical to the Brown and Sharpe (B&S) wire gauge.

Ammeter

An instrument that measures the magnitude of an electric current.

Ampere (Amp)

A unit that defines the rate of flow of electricity (current) in the circuit. Units are one coulomb (6.25 x 10¹⁸ electrons) per second.

Analog Output

A continuously variable signal that is used to represent a value, such as the process value or setpoint value. Typical hardware configurations are 0-20mA, 4-20mA or 0-5 Vdc.

Automatic Mode

A feature that allows the controller to set PID control outputs in response to the Process Variable (PV) and the setpoint.

Autotune

A feature that automatically sets temperature control PID values to match a particular thermal system.

B

Bandwidth

A symmetrical region above and below the setpoint in which proportional control occurs.

Baud Rate

The rate of information transfer in serial communications, measured in bits per second.

Block Check Character (BCC)

A serial communications error checking method. An acceptable method for most applications, BCC is the default method. See CRC.

Bumpless Transfer

A smooth transition from Auto (closed loop) to Manual (open loop) operation. The control output does not change during the transfer.

C**Calibration**

The comparison of a measuring device (an unknown) against an equal or better standard.

Celsius (Centigrade)

Formerly known as Centigrade. A temperature scale in which water freezes at 0°C and boils at 100°C at standard atmospheric pressure. The formula for conversion to the Fahrenheit scale is: °F=(1.8x°C)+32.

Central Processing Unit (CPU)

The unit of a computing system that includes the circuits controlling the interpretation of instructions and their execution.

Circuit

Any closed path for electrical current. A configuration of electrically or electromagnetically-connected components or devices.

Closed Loop

A control system that uses a sensor to measure a process variable and makes decisions based on that feedback.

Cold Junction

Connection point between thermocouple metals and the electronic instrument.

Common Mode Rejection Ratio

The ability of an instrument to reject electrical noise, with relation to ground, from a common voltage. Usually expressed in decibels (dB).

Communications

The use of digital computer messages to link components.
See Serial Communications.

See Baud Rate.

Control Action

The response of the PID control output relative to the error between the process variable and the setpoint. For reverse action (usually heating), as the process decreases below the setpoint the output increases. For direct action (usually cooling), as the process increases above the setpoint, the output increases.

Control Mode

The type of action that a controller uses. For example, On/Off, time proportioning, PID, Automatic or manual, and combinations of these.

Current

The rate of flow of electricity. The unit of measure is the ampere (A).
1 ampere = 1 coulomb per second.

Cycle Time

The time required for a controller to complete one on-off-on cycle. It is usually expressed in seconds.

Cyclic Redundancy Check (CRC)

An error checking method in communications. It provides a high level of data security but is more difficult to implement than Block Check Character (BCC).
See Block Check Character.

D**Data Logging**

A method of recording a process variable over a period of time. Used to review process performance.

Deadband

The range through which a variation of the input produces no noticeable change in the output. In the deadband, specific conditions can be placed on control output actions. Operators select the

deadband. It is usually above the heating proportional band and below the cooling proportional band.

Default Parameters

The programmed instructions that are permanently stored in the microprocessor software.

Derivative Control (D)

The last term in the PID algorithm. Action that anticipated the rate of change of the process, and compensates to minimize overshoot and undershoot. Derivative control is an instantaneous change of the control output in the same direction as the proportional error. This is caused by a change in the process variable (PV) that decreases over the time of the derivative (TD). The TD is in units of seconds.

Deutsche Industrial Norms (DIN)

A set of technical, scientific and dimensional standards developed in Germany. Many DIN standards have worldwide recognition.

Deviation Alarm

Warns that a process has exceeded or fallen below a certain range around the setpoint.

Digital to Analog Converter (DAC)

A device that converts a numerical input signal to a signal that is proportional to the input in some way.

Direct Action

An output control action in which an increase in the process variable, causes an increase in the output. Cooling applications usually use direct action.

Direct Current (DC)

An electric current that flows in one direction.

Distributed Zero Crossing (DZC)

A form of digital output control. Similar to burst fire.

A metal rod, usually copper, that provides an electrical path to the earth, to prevent or reduce the risk of electrical shock.

Electrical Noise

See Noise.

Electromagnetic Interference (EMI)

Electrical and magnetic noise imposed on a system. There are many possible causes, such as switching ac power on inside the sine wave. EMI can interfere with the operation of controls and other devices.

Electrical-Mechanical Relays

See Relay, electromechanical.

Emissivity

The ratio of radiation emitted from a surface compared to radiation emitted from a blackbody at the same temperature.

Engineering Units

Selectable units of measure, such as degrees Celsius and Fahrenheit, pounds per square inch, newtons per meter, gallons per minute, liters per minute, cubic feet per minute or cubic meters per minute.

EPROM

Erasable Programmable, Read-Only Memory inside the controller.

Error

The difference between the correct or desired value and the actual value.

E

Earth Ground

F**Fahrenheit**

The temperature scale that sets the freezing point of water at 32°F and its boiling point at 212°F at standard atmospheric pressure. The formula for conversion to Celsius is: $^{\circ}\text{C} = 5/9 (^{\circ}\text{F} - 32^{\circ}\text{F})$.

Failed Sensor Alarm

Warns that an input sensor no longer produces a valid signal. For example, when there are thermocouple breaks, infrared problems or resistance temperature detector (RTD) open or short failures.

Filter

Filters are used to handle various electrical noise problems.

Digital Filter (DF) — A filter that allows the response of a system when inputs change unrealistically or too fast. Equivalent to a standard resistor-capacitor (RC) filter

Digital Adaptive Filter — A filter that rejects high frequency input signal noise (noise spikes).

Heat/Cool Output Filter — A filter that slows the change in the response of the heat or cool output. The output responds to a step change by going to approximately 2/3 its final value within the numbers of scans that are set.

Frequency

The number of cycles over a specified period of time, usually measured in cycles per second. Also referred to as Hertz (Hz). The reciprocal is called the period.

G**Gain**

The amount of amplification used in an electrical circuit. Gain can also refer to the Proportional (P) mode of PID.

Global Alarm

Alarm associated with a global digital output that

is cleared directly from a controller or through a user interface.

Global Digital Outputs

A pre-selected digital output for each specific alarm that alerts the operator to shut down critical processes when an alarm condition occurs.

Ground

An electrical line with the same electrical potential as the surrounding earth. Electrical systems are usually grounded to protect people and equipment from shocks due to malfunctions. Also referred to a "safety ground".

H**Hertz(Hz)**

Frequency, measured in cycles per second.

High Deviation Alarm

Warns that the process is above setpoint, but below the high process variable. It can be used as either an alarm or control function.

High Power

(As defined by ANAFAZE) Any voltage above 24 VAC or Vdc and any current level above 50 mAac or mAdc.

High Process Alarm

A signal that is tied to a set maximum value that can be used as either an alarm or control function.

High Process Variable (PV)

See Process Variable (PV).

High Reading

An input level that corresponds to the high process value. For linear inputs, the high reading is a percentage of the full scale input range. For pulse inputs, the high reading is expressed in cycles per second (Hz).

I**Infrared**

A region of the electromagnetic spectrum with wavelengths ranging from one to 1,000 microns. These wavelengths are most suited for radiant

heating and infrared (noncontact) temperature sensing.

Input

Process variable information that is supplied to the instrument.

Input Scaling

The ability to scale input readings (readings in percent of full scale) to the engineering units of the process variable.

Input Type

The signal type that is connected to an input, such as thermocouple, RTD, linear or process.

Integral Control (I)

Control action that automatically eliminates offset, or droop, between setpoint and actual process temperature.

See Auto-reset.

J

Job

A set of operating conditions for a process that can be stored and recalled in a controller's memory. also called a Recipe.

Junction

The point where two dissimilar metal conductors join to form a thermocouple.

L

Lag

The delay between the output of a signal and the response of the instrument to which the signal is sent.

Linear Input

A process input that represents a straight line function.

Linearity

The deviation in response from an expected or theoretical straight line value for instruments and transducers. also called Linearity Error.

Liquid Crystal Display (LCD)

A type of digital display made of a material that

changes reflectance or transmittance when an electrical field is applied to it.

Load

The electrical demand of a process, expressed in power (watts), current (amps), or resistance (ohms). The item or substance that is to be heated or cooled.

Loop Alarm

Any alarm system that includes high and low process, deviation band, deadband, digital outputs, and auxiliary control outputs.

Low Deviation Alarm

Warns that the process is below the setpoint, but above the low process variable. It can be used as either an alarm or control function.

Low Process Alarm

A signal that is tied to a set minimum value that can be used as either an alarm or control function.

Low Reading

An input level corresponding to the low process value. For linear inputs, the low reading is a percentage of the full scale input range. For pulse inputs, the low reading is expressed in cycles per second (Hz).

M

Manual Mode

A selectable mode that has no automatic control aspects. The operator sets output levels.

Manual Reset

See Reset.

Milliampere (mA)

One thousandth of an ampere.

N

No Key Reset

A method for resetting the controller's memory (for instance, after an EPROM change).

Noise

Unwanted electrical signals that usually produce signal interference in sensors and sensor circuits.

See Electromagnetic Interference.

Noise Suppression

The use of components to reduce electrical interference that is caused by making or breaking electrical contact, or by inductors.

Non Linear

Through ANAFAZE software, the Non Linear field sets the system to linear control, or to one of two non linear control options. Input 0 for Linear, 1 or 2 for non linear.

O

Offset

The difference in temperature between the setpoint and the actual process temperature. Offset is the error in the process variable that is typical of proportional-only control.

On/Off Control

A method of control that turns the output full on until setpoint is reached, and then off until the process error exceeds the hysteresis.

Open Loop

A control system with no sensory feedback.

Operator Menus

The menus accessible from the front panel of a controller. These menus allow operators to set or change various control actions or features.

Optical Isolation

Two electronic networks that are connected through an LED (Light Emitting Diode) and a photoelectric receiver. There is no electrical continuity between the two networks.

Output

Control signal action in response to the difference between setpoint and process variable.

Output Type

The form of PID control output, such as Time Proportioning, Distributed Zero Crossing, SDAC, or Analog. Also the description of the electrical hardware that makes up the output.

Overshoot

The amount by which a process variable exceeds the setpoint before it stabilizes.

P

Panel Lock

A feature that prevents operation of the front panel by unauthorized people.

PID

Proportional, Integral, Derivative. A control mode with three functions: Proportional action dampens the system response, Integral corrects for droops, and Derivative prevents overshoot and undershoot.

Polarity

The electrical quality of having two opposite poles, one positive and one negative. Polarity determines the direction in which a current tends to flow.

Process Variable

The parameter that is controlled or measured. Typical examples are temperature, relative humidity, pressure, flow, fluid level, events, etc. The high process variable is the highest value of the process range, expressed in engineering units. The low process variable is the lowest value of the process range.

Proportional (P)

Output effort proportional to the error from setpoint. For example, if the proportional band is 20^o and the process is 10^o below the setpoint, the heat proportioned effort is 50%. The lower the PB value, the higher the gain.

Proportional Band (PB)

A range in which the proportioning function of the control is active. Expressed in units, degrees or percent of span.
See PID.

Proportional Control

A control using only the P (proportional) value of PID control.

Pulse Input

Digital pulse signals from devices, such as opti-

cal encoders.

R

Ramp

A programmed increase in the temperature of a setpoint system.

Range

The area between two limits in which a quantity or value is measured. It is usually described in terms of lower and upper limits.

Recipe

See Job.

Reflection Compensation Mode

A control feature that automatically corrects the reading from a sensor.

Relay

A switching device.

Electromechanical Relay — A power switching device that completes or interrupts a circuit by physically moving electrical contacts into contact with each other. Not recommended for PID control.

Solid State Relay (SSR) — A switching device with no moving parts that completes or interrupts a circuit electrically.

Reset

Control action that automatically eliminates offset or droop between setpoint and actual process temperature.

See also Integral.

Automatic Reset — The integral function of a PI or PID temperature controller that adjusts the process temperature to the setpoint after the system stabilizes. The inverse of integral.

Automatic Power Reset — A feature in latching limit controls that

Resistance

Opposition to the flow of electric current, measured in ohms.

Resistance Temperature Detector (RTD)

A sensor that uses the resistance temperature characteristic to measure temperature. There are two basic types of RTDs: the wire RTD, which is usually made of platinum, and the thermistor which is made of a semiconductor material. The wire RTD is a positive temperature coefficient sensor only, while the thermistor can have either a negative or positive temperature coefficient.

Reverse Action

An output control action in which an increase in the process variable causes a decrease in the output. Heating applications usually use reverse action.

RTD

See Resistance Temperature Detector.

S

Serial Communications

A method of transmitting information between devices by sending all bits serially over a single communication channel.

RS-232—An Electronics Industries of America (EIA) standard for interface between data terminal equipment and data communications equipment for serial binary data interchange. This is usually for communications over a short distance (50 feet or less) and to a single device.

RS-485—An Electronics Industries of America (EIA) standard for electrical characteristics of generators and receivers for use in balanced digital multipoint systems. This is usually used to communicate with multiple devices over a common cable or where distances over 50 feet are required.

Setpoint (SP)

The desired value programmed into a controller. For example, the temperature at which a system is to be maintained.

Shield

A metallic foil or braided wire layer surrounding

conductors that is designed to prevent electrostatic or electromagnetic interference from external sources.

Signal

Any electrical transmittance that conveys information.

Solid State Relay (SSR)

See Relay, Solid State.

Span

The difference between the lower and upper limits of a range expressed in the same units as the range.

Spread

In heat/cool applications, the +/- difference between heat and cool. Also known as process deadband.

See deadband.

Stability

The ability of a device to maintain a constant output with the application of a constant input.

T**T/C Extension Wire**

A grade of wire used between the measuring junction and the reference junction of a thermocouple. Extension wire and thermocouple wire have similar properties, but extension wire is less costly.

TD (Timed Derivative)

The derivative function.

Thermistor

A temperature-sensing device made of semiconductor material that exhibits a large change in resistance for a small change in temperature. Thermistors usually have negative temperature coefficients, although they are also available with positive temperature coefficients.

Thermocouple (T/C)

A temperature sensing device made by joining two dissimilar metals. This junction produces an electrical voltage in proportion to the difference

in temperature between the hot junction (sensing junction) and the lead wire connection to the instrument (cold junction).

TI (Timed Integral)

The Integral term.

Transmitter

A device that transmits temperature data from either a thermocouple or RTD by way of a two-wire loop. The loop has an external power supply. The transmitter acts as a variable resistor with respect to its input signal. Transmitters are desirable when long lead or extension wires produce unacceptable signal degradation.

U**Upscale Break Protection**

A form of break detection for burned-out thermocouples. Signals the operator that the thermocouple has burned out.

Undershoot

The amount by which a process variable falls below the setpoint before it stabilizes.

V

Volt (V)

The unit of measure for electrical potential, voltage or electromotive force (EMF).

See Voltage.

Voltage (V)

The difference in electrical potential between two points in a circuit. It's the push or pressure behind current flow through a circuit. One volt (V) is the difference in potential required to move one coulomb of charge between two points in a circuit, consuming one joule of energy. In other words, one volt (V) is equal to one ampere of current (I) flowing through one ohm of resistance (R), or $V=IR$.

Z

Zero Cross

Action that provides output switching only at or near the zero-voltage crossing points of the ac sine wave.

