

MINICHEF™ 2000

Applications 20 - 23

Griddle Applications Guide

Programming & Operating Steps



Watlow Controls

1241 Bundy Blvd.
P.O. Box 5580
Winona, Minnesota U.S.A. 55987-5580
(507) 454-5300, Fax (507) 452-4507

WMC2-XAGN-0004-Rev A
May 1997

CE 97

TOTAL
CUSTOMER
SATISFACTION

ISO 9001



\$5.00
Made in the U.S.A.

Application 20

Automatic Clam Shell Griddle

Dual Heat Channels, Six Menus

<i>Introduction to Application 20</i>	<i>1</i>
<i>Configuration Mode Quick Reference</i>	<i>3</i>
<i>Program Mode Quick Reference</i>	<i>4</i>
<i>Step 7 Design a Faceplate Overlay.</i>	<i>5</i>
<i>Step 8 Operate the Controller</i>	<i>6</i>

Application 20 allows you to program as many as six menus, each of which can control cooking temperatures and cooking times using a clam shell griddle (two-sided griddle). For each menu, program two heat channels, Channel 1 (typically bottom griddle) and Channel 2 (typically top griddle), and one cooking time.

Overview of Key Steps

1. Install the MINICHEF 2000.
2. Wire the controller.
3. Configure the controller.
4. Program the menus.
5. Set the controller security.
6. Set the Real-time Clock.

For instructions on Steps 1, 2, 3, 4, 5 and 6, see the *Hardware & Software Setup Guide*.

7. Design, manufacture and apply faceplate overlay for end-users. (For a suggested design to suit this application, see this section. For overlay dimensions and guidelines, see the *Hardware & Software Setup Guide*.)
8. Operate the controller. (See this application guide.)

Key Functions in Configuration Mode



Key Functions in Operation Mode

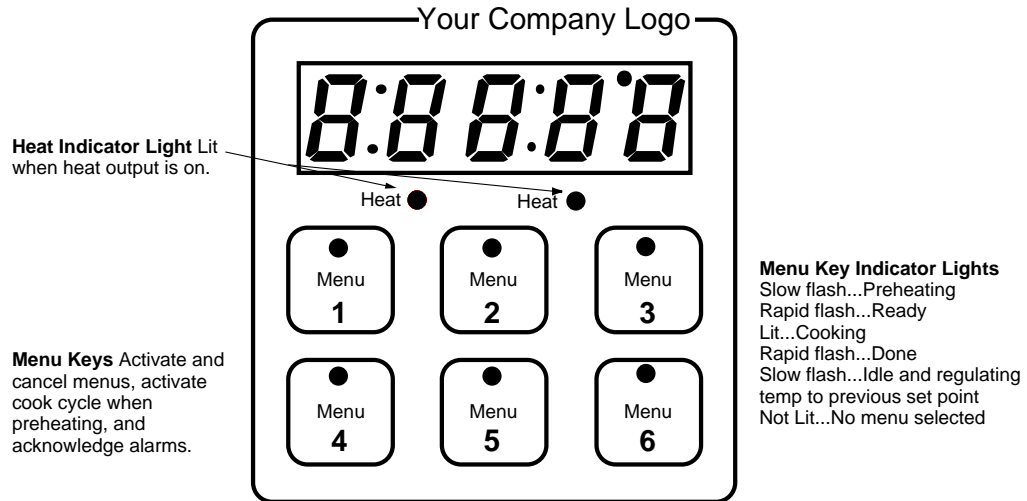

Summary of Input/Output Functions

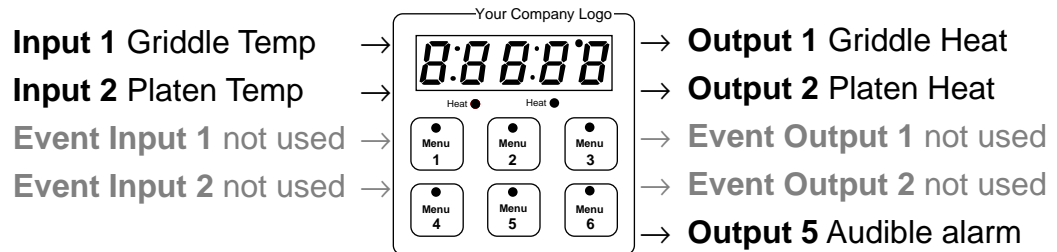

Note: For details, see wiring instructions in the *Hardware & Software Setup Guide*.

Configuration Mode Quick Reference

These are the functions, parameters and values included in the Configuration Mode for this application. You must select Application 20 to access them. For directions, see the *Hardware & Software Setup Guide*. The Appendix of that guide includes an explanation of all parameters and values.

Function	Parameter	Values	Your Settings
SEtYPE Equipment-Type	APPL Application Number	1 - 28	20
	A_Loc Application Number Security Lock	Yes, No	
	Sound Audible Alarm Sound	0 - 5	
SEtUP Setup	U_F Temperature Display Format	°C or °F	
	tiME Time Display Format	MMM:SS, HH:MM, H:MM:SS (H=Hours, M=Minutes, S=Seconds)	
	ChirP Key Chirp	On, Off	
	Loc Menu Security Lock	Yes, No	
	tc Thermocouple Type	J, K (shown as H), E	
	rtd RTD Curve	DIN, JIS	
	tcOnP WatCurve™ Temperature Compensation	On, Off	
	OFFSEt1 Temperature Offset Channel 1	-99 to 99°F (-55 to 55°C)	
	OFFSEt2 Temperature Offset Channel 2	-99 to 99°F (-55 to 55°C)	
	Er Lo Temperature Range Low	0°F (-18° C) for rtd inputs 32°F (0°C) for tc inputs to Er Hi	
	Er Hi Temperature Range High	Er Lo to 1200°F/649°C	
	PREAdY Preheat Ready Feature	Yes, No	
	rbAnd Ready Band	1 to 1200°F (649°C)	
	CLoc Real Time Clock Display	Yes, No	
	PLDSS Power Loss Menu Resume	Yes, No	
	AL 1 Alarm for Channel 1	None, Dev, Proc, Both	
	AL P1 Absolute Process Alarm 1	100 to 1200°F (38 to 649°C)	
	AL DL1 Low Deviation Alarm 1	-999 to 0°F (-555 to 0°C)	
	AL dH1 High Deviation Alarm 1	0 to 999°F (0 to 555°C)	
	AL 2 Alarm for Channel 2	None, Dev, Proc, Both	
	AL P2 Absolute Process Alarm 2	100 to 1200°F (38 to 649°C)	
	AL DL2 Low Deviation Alarm 2	-999 to 0°F (-555 to 0°C)	
AL dH2 High Deviation Alarm 2	0 to 999°F (0 to 555°C)		
ThERm Thermal	TYPE Temperature Control Type	Pid, On-Off	
	HYS1 Hysteresis 1	1 to 99°F (1 to 55°C)	
	HYS2 Hysteresis 2	1 to 99°F (1 to 55°C)	
	Pid U PID units	SI, US	
	tunE1 Auto-tuning 1	On, Off	
	tunE2 Auto-tuning 2	On, Off	
	ProP1 Proportional Band 1	1 to 999°F (1 to 555°C)	
	rSEt1 Reset (integral) Gain 1	0.00 to 9.99 repeats/minute	
	int 1 Integral Gain 1	0.00 to 99.99 minutes/repeat	
	rAtE1 Rate (derivative) Gain 1	0.00 to 9.99 minutes	
	dEr 1 Derivative Gain 1	0.00 to 9.99 minutes	
	CYCL1 PID Cycle Time 1	1 to 60 seconds	
	ProP2 Proportional Band 2	1 to 999°F (1 to 555°C)	
	rSEt2 Reset (integral) Gain 2	0.00 to 9.99 repeats/minute	
	int 2 Integral Gain 2	0.00 to 99.99 minutes/repeat	
rAtE2 Rate (derivative) Gain 2	0.00 to 9.99 minutes		
dEr 2 Derivative Gain 2	0.00 to 9.99 minutes		
CYCL2 PID Cycle Time 2	1 to 60 seconds		
dAG WatHelp Diagnostics	Used for equipment troubleshooting and testing. Not used when programming. See the <i>Hardware & Software Setup Guide</i> .		

Program Mode Quick Reference

These are the functions, parameters and values included in the Program Mode for this application. You must select Application 20 to access them. For menu programming directions, see the *Hardware & Software Setup Guide*. The Appendix of that guide includes a detailed explanation of all parameters and values.

Function	Parameter	Setting	Your Settings
PP -- Menu Numbers 1 - 6	SEPT1 Set point 1 Temperature of channel 1.	Temp range low to temp range high.	
	TIME1 Time 1 Menu run time.	Format varies based on configuration. Setting at 0 invalidates selected menu.	
	SEPT2 Set point 2	Temp range low to temp range high.	

Auto-tuning Note:

Before auto-tuning Application 20 for zone 1, Set Point 1 of Menu 1 must first be set to a value that is typical for zone 1. (See the *Hardware & Software Setup Guide* for information on programming menus.) Then set **TEMP1** / **TUNE1** to **on**. After you accept **on**, by pressing “Enter,” the controller will display **tune** while auto-tuning is taking place.

Then you can auto-tune zone 2, by first setting Set Point 1 of Menu 1 to a value that is typical for zone 2. Then set **TEMP2** / **TUNE2** to **on**. After you accept **on**, the controller will display **tune** while auto-tuning is taking place.

The controller will cancel the auto-tuning process if it cannot be completed in 80 minutes. You can cancel the auto-tuning process at any time by pressing either key C or key D and accepting **OFF**, by pressing “Enter,” when it appears.

Step 7 Design a Faceplate Overlay

To complete the installation, you must apply a graphic membrane to the front panel of the controller. The following artwork will help you design and create a membrane for this application. For more dimensions and guidelines, see the *Hardware & Software Setup Guide*.

Suggested End-user Overlay:

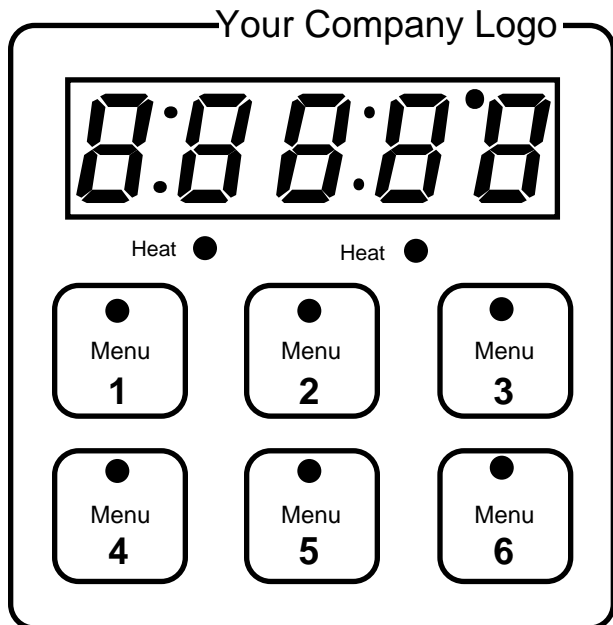

This Prototyping and Training Membrane Overlay will help you with the configuration and programming steps. To order it, see the Ordering Information at the back of this guide.

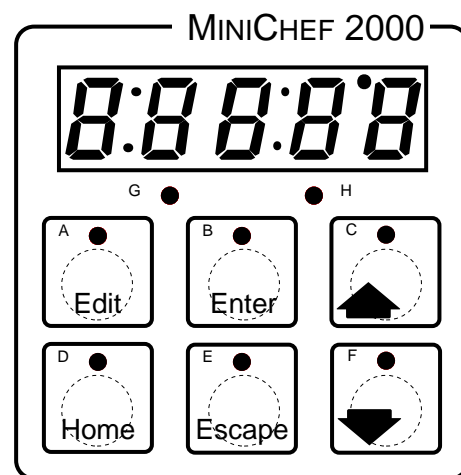

Step 8 Operating the Controller

Summary of Key Functions

Key	Function
A	Menu 1
B	Menu 2
C	Menu 3
D	Menu 4
E	Menu 5
F	Menu 6

Startup

Apply power to the griddle.

idLE will appear on the display.

If the Real-time Clock option is installed and **SETUP** / **CLoc** = **YES** the present time of day will appear on the display.

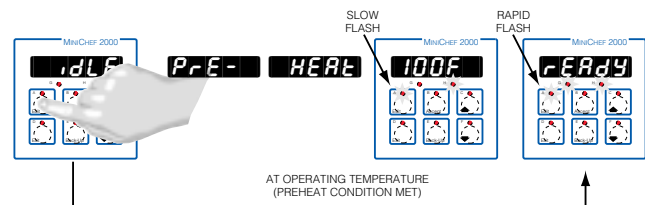

Preheat

If the **rEAdY** parameter under the **SETUP** function in the Configuration mode is set to **YES**, the controller will detect temperatures and preheat to operating temperature (above set point minus the ready band).

- Press the key for the menu you want to run. Each key selects a different menu. You can select from up to six menus that control temperature and cooking time. Only one menu may be run at a time.

Note: The controller will not respond if you select an invalid menu (one for which Time 1 is set to 0).

The menu you have chosen becomes the current menu for controller operation. Until the menu is completed or canceled, the indicator light above the menu key will light up (flashing or steady) to indicate the active menu.

- If the griddle is not at operating temperature, it will preheat. Meanwhile:
The word **PrE-** **HEAt** will appear on the display for a few moments.
The menu key indicator light will flash slowly.
The temperature of Channel 1 will be displayed until the operating temperature for both channels is reached.

The heat output indicator lights (G & H, just below the display) will light up whenever the controller is calling for heat.

When both channels are at operating temperature (set points minus the ready band) **rEAdy** will appear on the display and the menu key indicator light will flash rapidly. You are now ready to cook with the active menu.

If the griddle is at operating temperature, the display goes directly to **rEAdy** without indicating preheat or temperature.

Run a Menu (with preheat feature)

This procedure describes how to run an active menu when the preheat feature is active (when the **rEAdy** parameter in the **SEtUP** function of the Configuration Mode is set to **YES**).

1. With **idLE** or time of day on the display, press the key for the menu you want to run.

If the preheat condition (temperatures \geq set points minus the ready band) has not been met, the griddle will preheat until **rEAdy** appears on the display.

If the griddle is at operating temperature **rEAdy** will appear on the display.

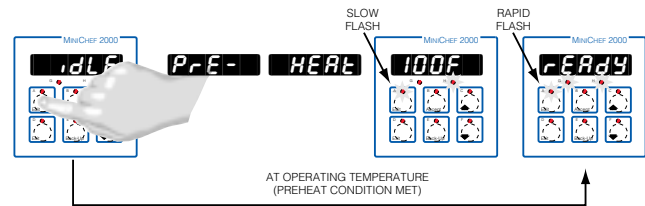

2. With **rEAdy** on the display, place the food on the bottom griddle, lower the top griddle, and press the active menu key (indicated by the rapidly flashing indicator light).

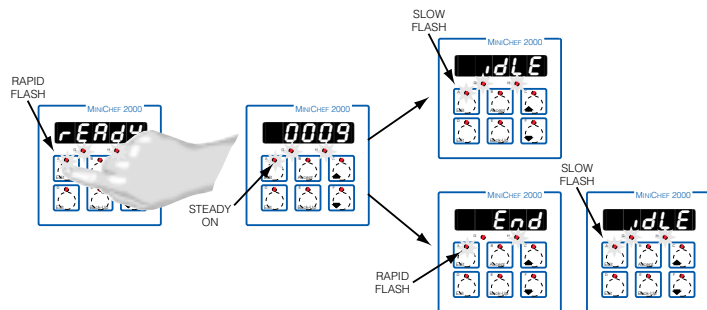

The menu key indicator light will light up. Time will count down on the display.

3. Depending on how the controller was configured at **EtYPE** / **Sound** the following will happen when the menu cycle is finished:

With Sound set to 0: The controller automatically switches to **idLE**, where the controller maintains the temperatures at set point and does not run time. **idLE** or current time of day will appear on the display. The menu key indicator light flashes slowly.

If Sound is set to 1, 2, or 3, **End** appears on the display and an audible tone

will be emitted. The menu key indicator light will flash rapidly. You can acknowledge and silence the tone by pressing the active menu key, or it will automatically time out within 20 seconds and go into idle while the menu key indicator light flashes slowly.

If Sound is set to 4 or 5, **End** will appear on the display and the menu key indicator light will flash rapidly. You must acknowledge the audible tone by pressing the active menu key. Once acknowledged, the audible tone is silenced and the controller goes into idle. The menu key indicator light will flash slowly.

4. Raise the top griddle and remove the food.

The controller will continue to regulate at the last set point that was run. The menu key indicator light will flash slowly.

5. To repeat cooking, repeat steps 1 through 4.

Run a Menu (without preheat feature)

This procedure describes how to run an active menu when the preheat feature is inactive (when the **Preheat** parameter in the **SETUP** function of the Configuration Mode is set to **no**).

1. With **idle** or time of day on the display, place the food on the griddle.
2. Lower the top griddle and press the key for the menu you want to run.

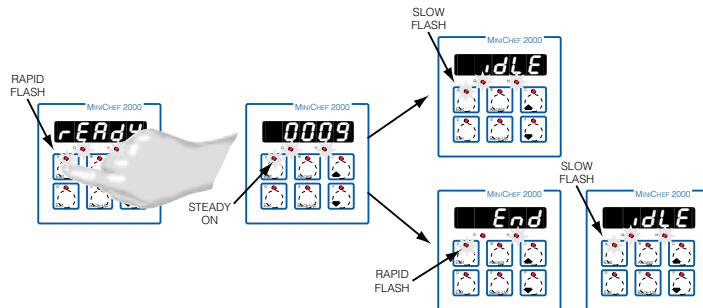

The menu key indicator light will light up. Time will count down on the display.

3. Depending on how the controller was configured at **ETYPE** / **Sound** the following will happen when the menu cycle is finished:

With Sound set to 0: The controller automatically switches to **idle**, where the controller maintains the temperatures at set point and does not run time. **idle** or current time of day will appear on the display. The menu key indicator light flashes slowly.

If Sound is set to 1, 2, or 3, **End** appears on the display and an audible tone will be emitted. The menu key indicator light will flash rapidly. You can acknowledge and silence the tone by pressing the active menu key, or it will automatically time out within 20 seconds and go into idle while the menu key indicator light flashes slowly.

If **Sound** is set to 4 or 5, **End** will appear on the display and the menu key indicator light will flash rapidly. You must acknowledge the audible tone by pressing the active menu key. Once acknowledged, the audible tone is silenced and the controller goes into idle. The menu key indicator light will flash slowly.

4. Raise the top griddle and remove the food.

The controller will continue to regulate at the last set point that was run. The menu key indicator light will flash slowly.

5. To repeat cooking, repeat steps 1 through 4.

Cancel a Menu

Canceling a menu stops controller operation completely. The controller does not maintain set point temperatures or run time. You cancel a menu to run another menu, stop menu operation for any reason, or are preparing to shut off the griddle.

- Press the active menu key for 2 seconds.

Heat outputs will switch off. Heat output indicator lights will switch off. **idLE** or the time of day will be on display.

Change Menus or Restart

1. If the controller is preheating or running a menu, cancel the menu by pressing and holding the active menu key for 2 seconds. If the controller is in **idLE** go to 2.
2. Press the key for the menu you want to run.

Based on its programming, the unit will run the menu in one of the ways described earlier.

Temperature Alarms

The controller will alert you to temperature alarm conditions if they occur. If an alarm occurs, take action as determined by your supervisor. See the Appendix in the *Hardware & Software Setup Guide* for a Troubleshooting Chart and a summary of temperature alarms.

Errors

The controller will alert you to errors if they occur. Errors are critical problems that shut down the unit. If an error occurs, an error message will appear on the display. You should switch off the power and call for service.

See the Appendix in the *Hardware & Software Setup Guide* for a Troubleshooting Chart and a summary of errors.

Notes

Application 21

Manual Clam Shell Griddle



Two Heat Channels

<i>Introduction to Application 21</i>	11
<i>Configuration Mode Quick Reference</i>	13
<i>Step 7 Design a Faceplate Overlay</i>	15
<i>Step 8 Operate the Controller</i>	16

Application 21 allows you to control cooking temperatures and cooking times using a clam shell griddle (two-sided griddle). There are two heat channels, Channel 1 (typically bottom griddle) and Channel 2 (typically top griddle), and one cooking time.

Overview of Key Steps

1. Install the MINICHEF 2000.
2. Wire the controller.
3. Configure the controller.
4. Program the menu.
5. Set the controller security.
6. Set the Real-time Clock.

For instructions on Steps 1, 2, 3, 4, 5 and 6, see the *Hardware & Software Setup Guide*.

7. Design, manufacture and apply faceplate overlay for end-users. (For a suggested design to suit this application, see this section. For overlay dimensions and guidelines, see the *Hardware & Software Setup Guide*.)
8. Operate the controller. (See this application guide.)

Key Functions in Configuration Mode



Key functions in Operation Mode

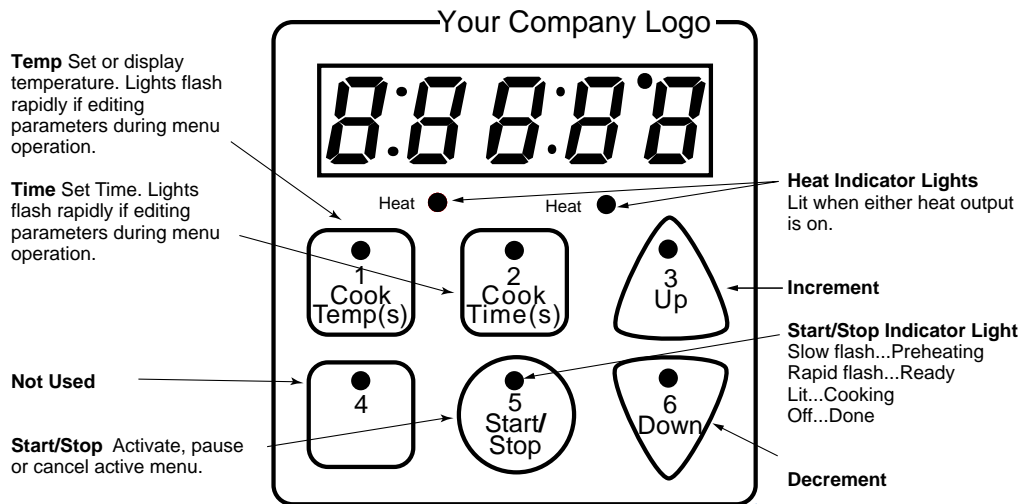

Summary of Input/Output Functions

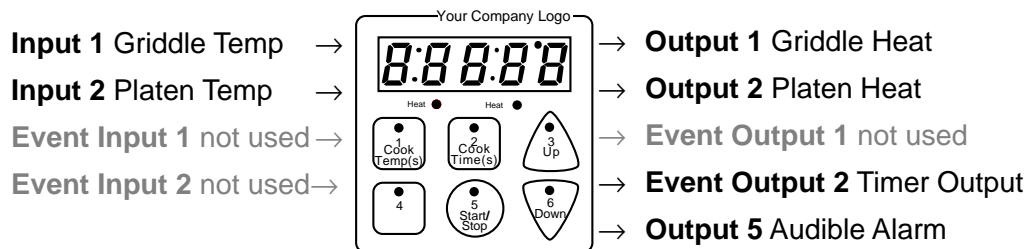

Note: For details, see wiring instructions in the *Hardware & Software Setup Guide*.

Configuration Mode Quick Reference

These are the functions, parameters and values included in the Configuration Mode for this application. You must select Application 21 to access them. For directions, see the *Hardware & Software Setup Guide*. The Appendix of that guide includes an explanation of all parameters and values.

Function	Parameter	Value	Your Settings
SETYPE Equipment-Type	APPL Application Number	1 - 28	21
	ALoc Application Number Security Lock	Yes, No	
SETUP Setup	EOU Timer Output	No, Yes	
	CF Temperature Display Format	°C or °F	
	TIME Time Display Format	MMM:SS, HH:MM, H:MM:SS (H=Hours, M=Minutes, S=Seconds)	
	Chirp Key Chirp	On, Off	
	tc Thermocouple Type	J, K (shown as H), E	
	rtd RTD Curve	DIN, JIS	
	tcconp WatCurve™ Temperature Compensation	On, Off	
	OFFSET1 Temperature Offset Channel 1	-99 to 99°F (-55 to 55°C)	
	OFFSET2 Temperature Offset Channel 2	-99 to 99°F (-55 to 55°C)	
	trLo Temperature Range Low	0°F (-18° C) for rtd inputs, 32°F (0°C) for tc inputs to trHi	
	trHi Temperature Range High	trLo to 1200°F (649°C)	
	READY Preheat Ready Feature	Yes, No	
	rband Ready Band	1 to 1200°F (649°C)	
	CLoc Real Time Clock Display	Yes, No	
	PLoss Power Loss Menu Resume	Yes, No	
	AL1 Alarms for channel 1	None, Dev, Proc, Both	
	ALP1 Absolute Process Alarm 1	100 to 1200°F (38 to 649°C)	
	ALDL1 Low Deviation Alarm 1	-999 to 0°F (-555 to 0°C)	
	ALDH1 High Deviation Alarm 1	0 to 999°F (0 to 555°C)	
AL2 Alarm for channel 2	None, Dev, Proc, Both		
ALP2 Absolute Process Alarm 2	100 to 1200°F (38 to 649°C)		
ALDL2 Low Deviation Alarm 2	-999 to 0°F (-555 to 0°C)		
ALDH2 High Deviation Alarm 2	0 to 999°F (0 to 555°C)		
TEMPERL Thermal	TYPE Temperature Control Type	PID, On-Off	
	HYS1 Hysteresis 1	1 to 99°F (1 to 55°C)	
	HYS2 Hysteresis 2	1 to 99°F (1 to 55°C)	
	PIDU PID Units	SI, US	
	Auto1 Auto-tuning 1	on, OFF	
	Auto2 Auto-tuning 2	on, OFF	
	PROP1 Proportional Band 1	1 to 999°F (1 to 555°C)	
	RS1 Reset (integral) Gain 1	0.00 to 9.99 repeats/minute	
	int1 Integral Gain 1	0.00 to 99.99 minutes/repeat	
	RA1 Rate (derivative) Gain 1	0.00 to 9.99 minutes	
	DER1 Derivative Gain 1	0.00 to 9.99 minutes	
	CYCL1 PID Cycle Time 1	1 to 60 seconds	
	PROP2 Proportional Band 2	1 to 999°F (1 to 555°C)	
	RS2 Reset (integral) Gain 2	0.00 to 9.99 repeats/minute	
	int2 Integral Gain 2	0.00 to 99.99 minutes/repeat	
RA2 Rate (derivative) Gain 2	0.00 to 9.99 minutes		
DER2 Derivative Gain 2	0.00 to 9.99 minutes		
CYCL2 PID Cycle Time 2	1 to 60 seconds		
diag WatHelp Diagnostics	Used for equipment troubleshooting and testing. Not used when programming. See the <i>Hardware & Software Setup Guide</i> .		

Auto-tuning Note:

Before auto-tuning Application 21 for zone 1, **TEMP 1** must first be set to a value that is typical for zone 1. (See the *Hardware & Software Setup Guide* for information on programming menus.) Then set **TEMP 1 / TUNE 1** to **on**. After you accept **on**, by pressing “Enter,” the controller will display **TUNE** while auto-tuning is taking place.

Then you can auto-tune zone 2, by first setting **TEMP 1** of Menu 1 to a value that is typical for zone 2. Then set **TEMP 1 / TUNE 2** to **on**. After you accept **on**, by pressing “Enter,” the controller will display **TUNE** while auto-tuning is taking place.

The controller will cancel the auto-tuning process if it cannot be completed in 80 minutes. You can cancel the auto-tuning process at any time by pressing either key C or key D and accepting **OFF**, by pressing “Enter,” when it appears.

Step 7 Design a Faceplate Overlay

To complete the installation, you must apply a graphic membrane to the front panel of the controller. The following artwork will help you design and create a membrane for this application. For more dimensions and guidelines, see the *Hardware & Software Setup Guide*.

Suggested End-user Overlay:

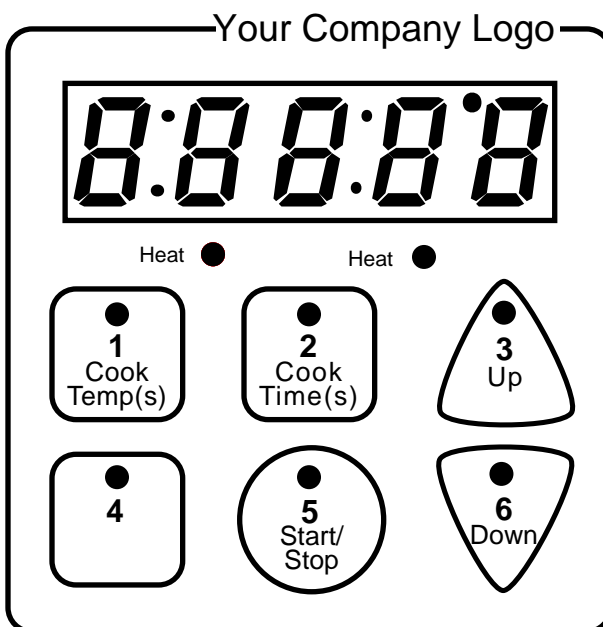

This Prototyping and Training Membrane Overlay will help you with the configuration and programming steps. To order it, see the Ordering Information at the back of this guide.

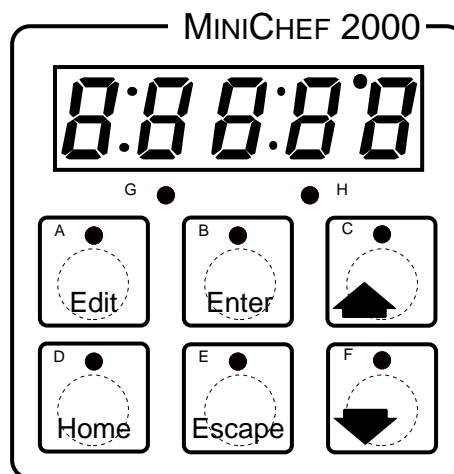

Step 8 Operate the Controller

Summary of Key Functions in Operation Mode

Key	Operation Function
A	Cook Temp(s)
B	Cook Time
C	Up (Increment)
D	Not Used
E	Start/Stop
F	Down (Decrement)

Startup

Apply power to the griddle.

idLE will appear on the display.

If the Real-time Clock option is installed and **SEtUP** / **CLoc** = **YES** the present time of day will appear on the display.

Set the Menu

Set the cooking temperatures.

1. Press the Cook Temp key for **TEMP 1** and then the cooking temperature value will appear on the display.
2. Press the Up-arrow or Down-arrow key until the value you want appears on the display.
3. Press the Cook Temp key again for **TEMP 2** and repeat steps 1 and 2.
4. Press the Cook Temp key again.

The cooking temperatures have been set.

idLE will appear on the display.

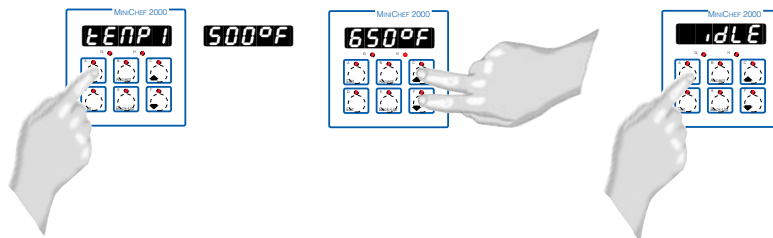

Set the cooking time.

1. Press the Cook Time key **TIME 1** and then the cooking time value will appear on the display.
2. Press the Up-arrow or Down-arrow key until the value you want appears on the display.

3. Press the Cook Time key again.

The cooking time has been set.

idLE will appear on the display.

Five Second Timeout

When using the up or down keys to change a value, if you do not press any key for 5 seconds, the controller will automatically be set to the last value on the display and return to **idLE**.

Preheat

If the **rEAdy** parameter under the **SEtUP** function in the Configuration mode is set to **YES**, the controller will detect temperatures and preheat to operating temperature (above set point minus the ready band).

Note: The controller will not respond if Time1 is set to 0.

- If the griddle is not at operating temperature, it will preheat. Meanwhile:
The word **PrE- HEAt** will appear on the display for a few moments.
The Start/Stop key indicator light will flash slowly.
The temperature of Channel 1 will be displayed until the operating temperature for both channels is reached.
The heat output indicator lights (G & H, just below the display) will light up whenever the controller is calling for heat.
When both channels are at operating temperature (set points minus the ready band) **rEAdy** will appear on the display and the Start/Stop key indicator light will flash rapidly. You are now ready to cook with the active menu.
- If the griddle is at operating temperature, the display goes directly to **rEAdy** without indicating preheat or temperature.

Run a Menu (with preheat feature)

This procedure describes how to run an active menu when the preheat feature is active (when the **rEAdy** parameter in the **SEtUP** function of the Configuration Mode is set to **YES**).

1. Set the menu as shown earlier.
2. With **idLE** or time of day on the display, press the Start/Stop key.

If the preheat condition (temperatures \geq set points minus the ready band) has not been met, the griddle will preheat until **rEAdy** appears on the display.

If the griddle is at operating temperature **rEAdy** will appear on the display.

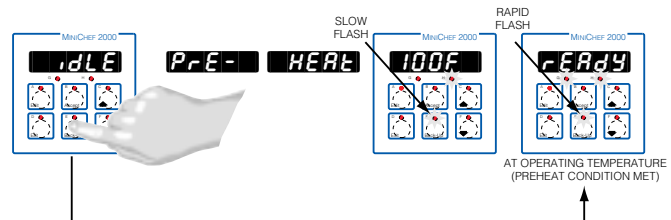

- With **rERdy** on the display, place the food on the bottom griddle, lower the top griddle, and press the Start/Stop key (indicated by the rapidly flashing indicator light).

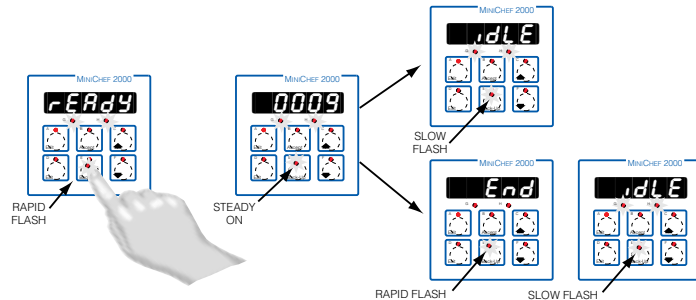

The Start/Stop indicator light will light up. Time will count down on the display.

- When the cooking cycle is finished, the controller goes into idle and the Start/Stop key indicator light will switch off. The controller will regulate to the setpoint temperature.
- Raise the top griddle and remove the food.
- To repeat cooking, repeat steps 2 through 5.

Run a Menu (without preheat feature)

This procedure describes how to run an active menu when the preheat feature is inactive (when the **rERdy** parameter in the **SETUP** function of the Configuration Mode is set to **no**).

- Set the menu as shown earlier.
- With **idle** or time of day on the display, press the Start/Stop key.
- Lower the top griddle and press the Start/Stop key.

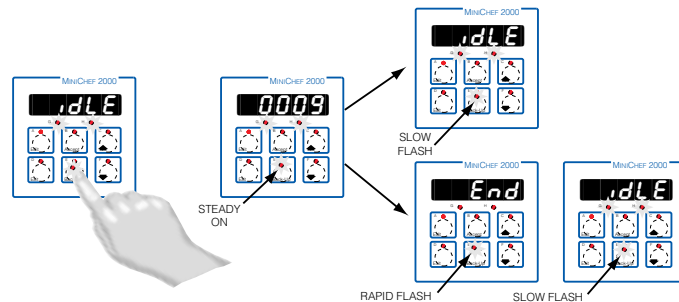

The Start/Stop indicator light will light up. Time will count down on the display.

- When the cooking cycle is finished, the controller goes into idle and the Start/Stop key indicator light will switch off. The controller will regulate to the setpoint temperature.
- Raise the top griddle and remove the food.
- To repeat cooking, repeat steps 2 through 5.

Cancel a Menu

Canceling a menu stops controller operation completely. The controller does not main-

tain set point temperatures or run time. You cancel a menu to run another menu, stop menu operation for any reason, or are preparing to shut off the griddle.

- Press the Start/Stop for 2 seconds.

Heat outputs will switch off. Heat output indicator lights will switch off. **idLE** or the time of day will be on display.

Adjust a Menu While Cooking

You can adjust the temperature and time settings during the cooking and hold sequences by performing the actions shown under “Set the Menu” earlier in this section.

Changes can be made to temperature and time only during the portion of the cooking sequence in which they are active. For example: a change to the first cooking temperature **TEMP 1** can be made only when the first cooking temperature is being run during the cooking sequence.

Temperature changes made while cooking are saved and become part of the permanent menu. Time changes are not saved and do not become part of the permanent menu.

Change Menus or Restart

1. If the controller is preheating or running the menu, cancel the menu by pressing and holding the Start/Stop for 2 seconds. If the controller is in **idLE** go to 2.
2. Press the Start/Stop key.

Based on its programming, the unit will run the menu in one of the ways described earlier.

Timer Output

If **TYPE / OUT** in the Configuration Mode is set to **YES**, when time is counting down Event Output 2 is on. It is off during **PAUSE**, **idLE** or **Hold**.

Temperature Alarms

The controller will alert you to temperature alarm conditions if they occur. If an alarm occurs, take action as determined by your supervisor. See the Appendix in the *Hardware & Software Setup Guide* for a Troubleshooting Chart and a summary of temperature alarms.

Errors

The controller will alert you to errors if they occur. Errors are critical problems that shut down the unit. If an error occurs, an error message will appear on the display. You should switch off the power and call for service.

See the Appendix in the *Hardware & Software Setup Guide* for a Troubleshooting Chart and a summary of errors.

Notes

Application 22

Automatic One-Sided Griddle

One Heat Channel, Six Menus

<i>Introduction to Application 22</i>	21
<i>Configuration Mode Quick Reference</i>	23
<i>Program Mode Quick Reference</i>	24
<i>Step 7 Design a Faceplate Overlay</i>	25
<i>Step 8 Operate the Controller</i>	26

Application 22 allows you to program as many as six menu keys to control one temperature channel and cooking time for an automatic one-sided griddle.

Overview of Key Steps

1. Install the MINICHEF 2000.
2. Wire the controller.
3. Configure the controller.
4. Program the menus.
5. Set the controller security.
6. Set the Real-time Clock.

For instructions on Steps 1, 2, 3, 4, 5 and 6, see the *Hardware & Software Setup Guide*.

7. Design, manufacture and apply faceplate overlay for end-users. (For a suggested design to suit this application, see this section. For overlay dimensions and guidelines, see the *Hardware & Software Setup Guide*.)
8. Operate the controller. (See this application guide.)

Key Functions in Configuration Mode



Key Functions in Operation Mode



Summary of Input/Output Functions

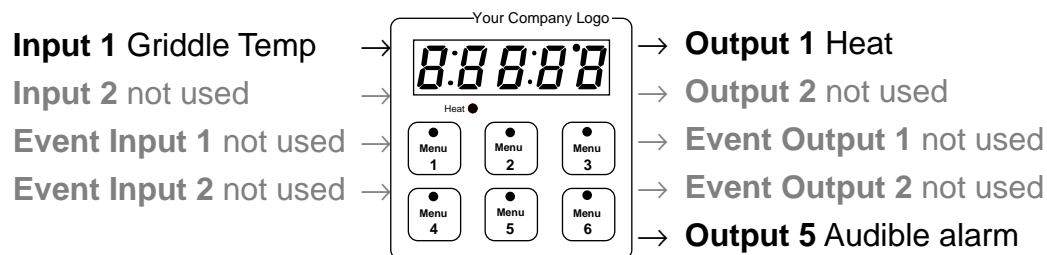

Note: For details, see wiring instructions in the *Hardware & Software Setup Guide*.

Configuration Mode Quick Reference

These are the functions, parameters and values included in the Configuration Mode for this application. You must select Application 22 to access them. For directions, see the *Hardware & Software Setup Guide*. The Appendix of that guide includes an explanation of all parameters and values.

Function	Parameter	Value	Your Settings
E E Y P E Equipment-Type	A P P L Application Number	1 - 28	22
	A _ L o c Application Number Security Lock	Yes, No	
S E T U P Setup	S o u n d Audible Alarm Sound	0 - 5	
	C _ F Temperature Display Format	°C or °F	
	T _ I M E Time Display Format	MMM:SS, HH:MM, H:MM:SS (H=Hours, M=Minutes, S=Seconds)	
	C h i r p Key Chirp	On, Off	
	L o c Menu Security Lock	Yes, No	
	T c Thermocouple Type	J, K (shown as H), E	
	r t d RTD Curve	DIN, JIS	
	t c o n P WatCurve™ Temperature Compensation	On, Off	
	O F S E T 1 Temperature Offset, Channel 1	-99 to 99°F (-55 to 55°C)	
	T r L o Temperature Range Low	0°F (-18°C) for rtd inputs, 32°F (0°C) for tc inputs to T r H i	
	T r H i Temperature Range High	T r L o to 1200°F (649°C)	
	P R E A D Y Preheat Ready Feature	Yes, No	
	r b A n d Ready Band	1 to 1200°F (649°C)	
	C l o c Real Time Clock Display	Yes, No	
	P L O S S Power Loss Menu Resume	Yes, No	
	T H E R M Thermal	A L 1 Alarms for channel 1	None, Dev, Proc, Both
		A L P 1 Absolute Process Alarm 1	100 to 1200°F (38 to 649°C)
A L d L 1 Low Deviation Alarm 1		-999 to 0°F (-555 to 0°C)	
A L d H 1 High Deviation Alarm 1		0 to 999°F (0 to 555°C)	
T Y P E Temperature Control Type		PID, On-Off	
H Y S T 1 Hysteresis 1		1 to 99°F (1 to 55°C)	
P i d U PID Units		SI, US	
t u n E 1 Auto-tuning 1		on, OFF	
P r o P 1 Proportional Band 1		1 to 999°F (1 to 555°C)	
r S E T 1 Reset (integral) Gain 1		0.00 to 9.99 repeats/minute	
i n t 1 Integral Gain 1		0.00 to 99.99 minutes/repeat	
r A T E 1 Rate (derivative) Gain 1		0.00 to 9.99 minutes	
d E r 1 Derivative Gain 1		0.00 to 9.99 minutes	
C y c l 1 PID Cycle Time 1	1 to 60 seconds		
d . A G WatHelp Diagnostics	Used for equipment troubleshooting and testing. Not used when programming. See the <i>Hardware & Software Setup Guide</i> .		

Program Mode Quick Reference

These are the functions, parameters and values included in the Program Mode for this application. You must select Application 22 to access them. For menu programming directions, see the *Hardware & Software Setup Guide*. The Appendix of that guide includes a detailed explanation of all parameters and values.

Function	Parameter	Value	Your Settings
P7 - - Menu Numbers 1 - 6	SETE1 Set point 1 Temperature of set point 1.	Temp range low to temp range high	
	TIME1 Time 1 Run time of set point 1.	Format varies based on configuration.	
	ALARM Mid-menu Alarm	Stir, Add, Flip, Turn, Alert, None	
	ALINE Mid-menu alarm time.	0 to Time 1	

Auto-tuning Note:

Before auto-tuning Application 22, the Set Point 1 of Menu 1 must first be set to a value that is typical of your application. (See the *Hardware & Software Setup Guide* for information on programming menus.) Then set **TEMP1** / **TUNE1** to **on**. After you accept **on**, by pressing “Enter,” the controller will display **tune** while auto-tuning is taking place.

The controller will cancel the auto-tuning process if it cannot be completed in 80 minutes. You can cancel the auto-tuning process at any time by pressing either key C or key D and accepting **OFF**, by pressing “Enter,” when it appears.

Step 7 Design a Faceplate Overlay

To complete the installation, you must apply a graphic membrane to the front panel of the controller. The following artwork will help you design and create a membrane for this application. For more dimensions and guidelines, see the *Hardware & Software Setup Guide*.

Suggested End-user Overlay:

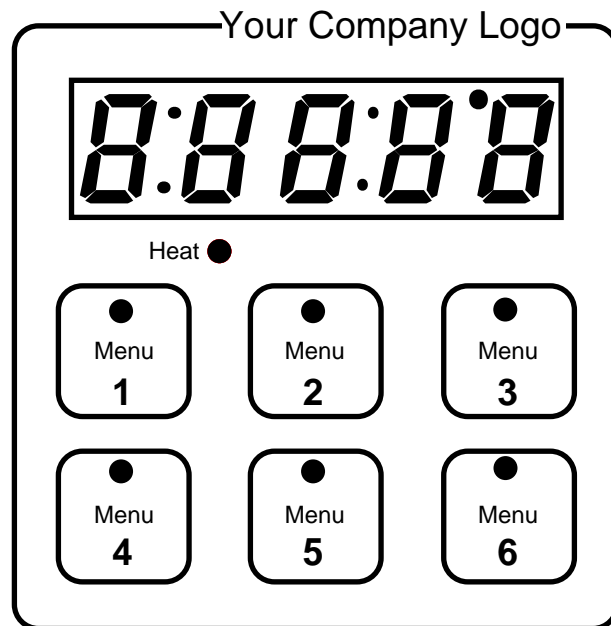

This Prototyping and Training Membrane Overlay will help you with the configuration and programming steps. To order it, see the Ordering Information at the back of this guide.

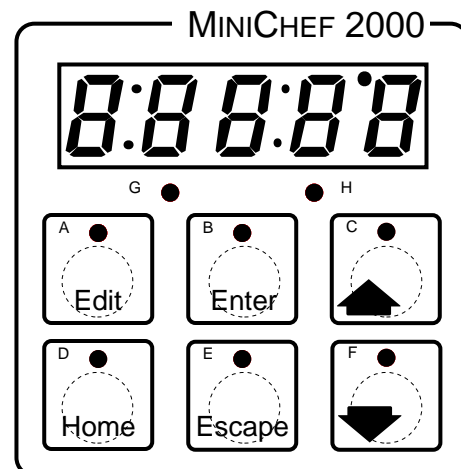

Step 8 Operate the Controller

Summary of Key Functions in Operation Mode

Key	Function
A	Menu 1
B	Menu 2
C	Menu 3
D	Menu 4
E	Menu 5
F	Menu 6

Startup

Apply power to the griddle.

idLE will appear on the display.

If the Real-time Clock option is installed and **SETUP** / **CLoc** = **YES** the present time of day will appear on the display.

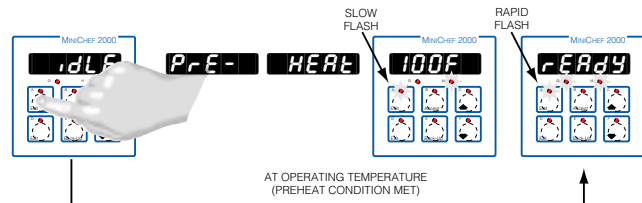

Preheat

If the **rEAdY** parameter under the **SETUP** function in the Configuration Mode is set to **YES**, the controller will detect the temperature and preheat to operating temperature (above set point minus the ready band).

- Press the key for the menu you want to run. Each key selects a different menu. You can select from up to six menus that control temperature and cooking time. Only one menu may be run at a time.

Note: The controller will not respond if you select an invalid menu (one for which Time1 is set to 0).

The menu you have chosen becomes the current menu for controller operation. Until the menu is completed or canceled, the indicator light above the menu key will light up (flashing or steady) to indicate the active menu.

- If the griddle is not at operating temperature, it will preheat. Meanwhile:
The word **PrE- HEAT** will appear on the display for a few moments.
The menu key indicator light will flash slowly.
The temperature of Channel 1 will be displayed until the operating temperature for Channel 1 is reached.

The heat output indicator light (G, just below the display) will light up whenever the controller is calling for heat.

When Channel 1 is at operating temperature (set point minus the ready band) **rEAdy** will appear on the display and the menu key indicator light will flash rapidly. You are now ready to cook with the active menu.

- If the griddle is at operating temperature, the display goes directly to **rEAdy** without indicating preheat or temperature.

Run a Menu (with preheat feature)

This procedure describes how to run an active menu when the preheat feature is active (when the **rEAdy** parameter in the **SETUP** function of the Configuration Mode is set to **YES**).

1. With **idLE** or time of day on the display, press the key for the menu you want to run.

If the preheat condition (temperature \geq set point minus the ready band) has not been met, the griddle will preheat until **rEAdy** appears on the display.

If the griddle is at operating temperature **rEAdy** will appear on the display.

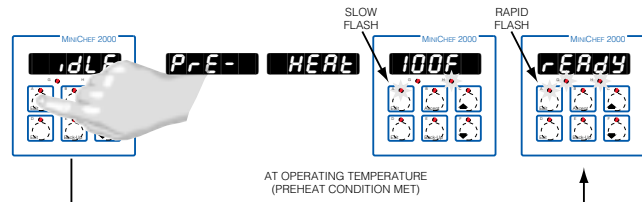

2. With **rEAdy** on the display, place the food on the griddle and press the active menu key (indicated by the rapidly flashing indicator light).

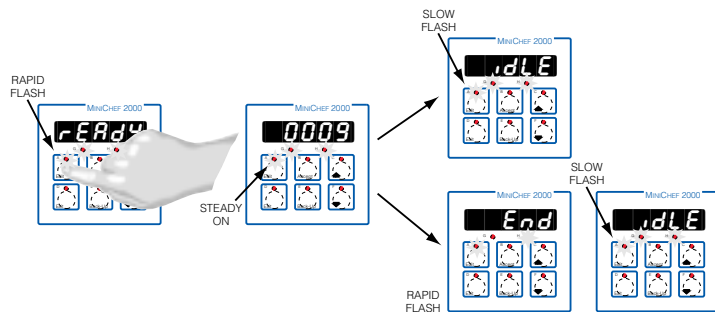

The menu key indicator light will light up. Time will count down on the display.

3. Depending on how the controller was configured at **EtYPE** / **Sound** the following will happen when the menu cycle is finished:

With Sound set to 0: The controller automatically switches to **idLE**, where the controller maintains the temperatures at set point. **idLE** or current time of day will appear on the display. The menu key indicator light flashes slowly.

If Sound is set to 1, 2, or 3, **End** appears on the display and an audible tone will be emitted. The menu key indicator light will flash rapidly. You can acknowledge and silence the tone by pressing the active menu key, or it will automatically time out within 20 seconds and go into idle while the menu key indicator light flash-

es slowly.

If Sound is set to 4 or 5, **End** will appear on the display and the menu key indicator light will flash rapidly. You must acknowledge the audible tone by pressing the active menu key. Once acknowledged, the audible tone is silenced and the controller goes into idle. The menu key indicator light will flash slowly.

4. Remove the food from the griddle.

The controller will continue to regulate at the last set point that was run. The menu key indicator light will flash slowly.

5. To repeat cooking, repeat steps 1 through 4.

Run a Menu (without preheat feature)

This procedure describes how to run an active menu when the preheat feature is inactive (when the **rEAdy** parameter in the **SEtUP** function of the Configuration Mode is set to **no**).

1. With **idLE** or time of day on the display, place the food on the griddle.
2. Press the key for the menu you want to run.

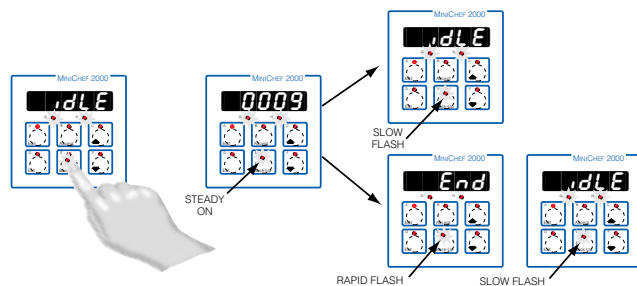

The menu key indicator light will light up. Time will count down on the display.

3. Depending on how the controller was configured at **EtYPE** / **Sound** the following will happen when the menu cycle is finished:

With Sound set to 0: The controller automatically switches to **idLE**, where the controller maintains the temperatures at set point and does not run time. **idLE** or current time of day will appear on the display. The menu key indicator light flashes slowly.

If Sound is set to 1, 2, or 3, **End** appears on the display and an audible tone will be emitted. The menu key indicator light will flash rapidly. You can acknowledge and silence the tone by pressing the active menu key, or it will automatically time out within 20 seconds and go into idle while the menu key indicator light flashes slowly.

If **Sound** is set to 4 or 5, **End** will appear on the display and the menu key indicator light will flash rapidly. You must acknowledge the audible tone by pressing the active menu key. Once acknowledged, the audible tone is silenced and the controller goes into idle. The menu key indicator light will flash slowly.

4. Remove the food from the griddle.

The controller will continue to regulate at the last set point that was run. The menu key indicator light will flash slowly.

5. To repeat cooking, repeat steps 1 through 4.

Cancel a Menu

Canceling a menu stops controller operation completely. The controller does not maintain set point temperatures or run time. You cancel a menu to run another menu, stop menu operation for any reason, or are preparing to shut off the griddle.

- Press the active menu key for 2 seconds.

The heat output will switch off. The heat output indicator light will switch off. **idLE** or the time of day will be on display.

Change Menus or Restart

1. If the controller is preheating or running a menu, cancel the menu by pressing and holding the active menu key for 2 seconds. If the controller is in **idLE** go to 2.
2. Press the key for the menu you want to run.

Based on its programming, the unit will run the menu in one of the ways described earlier.

Temperature Alarms

The controller will alert you to temperature alarm conditions if they occur. If an alarm occurs, take action as determined by your supervisor. See the Appendix in the *Hardware & Software Setup Guide* for a Troubleshooting Chart and a summary of temperature alarms.

Errors

The controller will alert you to errors if they occur. Errors are critical problems that shut down the unit. If an error occurs, an error message will appear on the display. You should switch off the power and call for service.

See the Appendix in the *Hardware & Software Setup Guide* for a Troubleshooting Chart and a summary of errors.

Notes

Application 23

Manual One-Sided Griddle

One Heat Channel

<i>Introduction to Application 23</i>	<i>31</i>
<i>Configuration Mode Quick Reference</i>	<i>33</i>
<i>Step 7 Design a Faceplate Overlay</i>	<i>35</i>
<i>Step 8 Operate the Controller</i>	<i>36</i>

Application 23 allows you to program a menu to control one temperature channel and cooking time for a manual one-sided griddle.

Overview of Key Steps

1. Install the MINICHEF 2000.
 2. Wire the controller.
 3. Configure the controller.
 4. Program the menu.
 5. Set the controller security.
 6. Set the Real-time Clock.
- For instructions on Steps 1, 2, 3, 4, 5 and 6, see the *Hardware & Software Setup Guide*.
7. Design, manufacture and apply faceplate overlay for end-users. (For a suggested design to suit this application, see this section. For overlay dimensions and guidelines, see the *Hardware & Software Setup Guide*.)
 8. Operate the controller. (See this application guide.)

Key Functions in Configuration Mode



Key Functions in Operation Mode

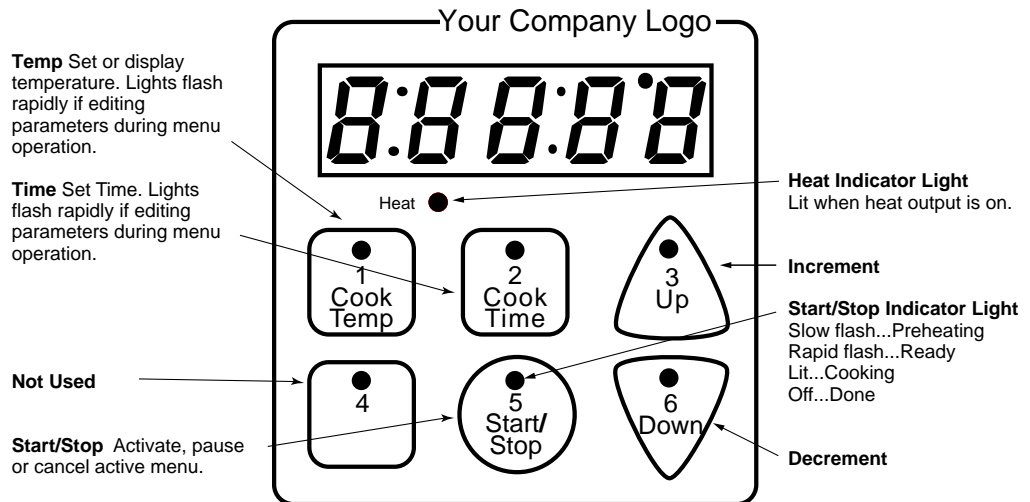

Summary of Input/Output Functions

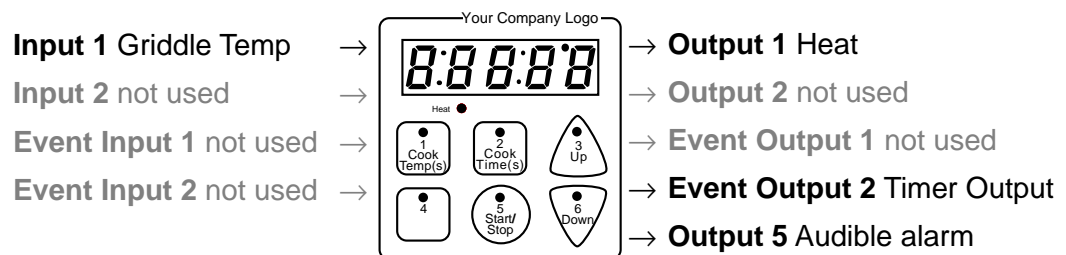

Note: For details, see wiring instructions in the *Hardware & Software Setup Guide*.

Configuration Mode Quick Reference

These are the functions, parameters and values included in the Configuration Mode for this application. You must select Application 23 to access them. For directions, see the *Hardware & Software Setup Guide*. The Appendix of that guide includes an explanation of all parameters and values.

Function	Parameter	Value	Your Settings
EqUPE Equipment-Type	APPL Application Number	1 - 28	23
	A_Loc Application Number Security Lock	Yes, No	
SEtUP Setup	tOUt Timer Output	No, Yes	
	t_F Temperature Display Format	°C or °F	
	t_rFE Time Display Format	MMM:SS, HH:MM, H:MM:SS (H=Hours, M=Minutes, S=Seconds)	
	ChirP Key Chirp	On, Off	
	tC Thermocouple Type	J, K (shown as H), E	
	rtd RTD Curve	DIN, JIS	
	tconP WatCurve™ Temperature Compensation	On, Off	
	OFFSEt 1 Temperature Offset, Channel 1	-99 to 99°F (-55 to 55°C)	
	t_r Lo Temperature Range Low	0°F (-18°C) for rtd inputs, 32°F (0°C) for tc inputs to t_r Hi	
	t_r Hi Temperature Range High	t_r Lo to 1200°F (649°C)	
	rERADY Preheat Ready Feature	Yes, No	
	rband Ready Band	1 to 1200°F (649°C)	
	tLoc Real Time Clock Display	Yes, No	
	PLoSS Power Loss Menu Resume	Yes, No	
	AL 1 Alarms for channel 1	None, Dev, Proc, Both	
	AL P 1 Absolute Process Alarm 1	100 to 1200°F (38 to 649°C)	
	AL dL 1 Low Deviation Alarm 1	-999 to 0°F (-555 to 0°C)	
AL dH 1 High Deviation Alarm 1	0 to 999°F (0 to 555°C)		
tHErL Thermal	tYPE Temperature Control Type	PID, On-Off	
	HYSL 1 Hysteresis 1	1 to 99°F (1 to 55°C)	
	Pid U PID Units	SI, US	
	tUNE 1 Auto-tuning 1	on, OFF	
	ProP 1 Proportional Band 1	1 to 999°F (1 to 555°C)	
	rSEt 1 Reset (integral) Gain 1	0.00 to 9.99 repeats/minute	
	int 1 Integral Gain 1	0.00 to 99.99 minutes/repeat	
	rAtE 1 Rate (derivative) Gain 1	0.00 to 9.99 minutes	
	dEr 1 Derivative Gain 1	0.00 to 9.99 minutes	
	CYCL 1 PID Cycle Time 1	1 to 60 seconds	
	dAG WatHelp Diagnostics	Used for equipment troubleshooting and testing. Not used when programming. See the <i>Hardware & Software Setup Guide</i> .	

Auto-tuning Note:

Before auto-tuning Application 23, **tEMP1** in the operations menu must first be set to a value that is typical of your application (See the *Hardware & Software Setup Guide* for information on programming menus.). Then set **tHERL / tUnE1** to **on**. After you accept **on**, by pressing “Enter,” the controller will display **tUnE** while auto-tuning is taking place.

The controller will cancel the auto-tuning process if it cannot be completed in 80 minutes. You can cancel the auto-tuning process at any time by pressing either key C or key D and accepting **OFF**, by pressing “Enter,” when it appears.

Step 7 Design a Faceplate Overlay

To complete the installation, you must apply a graphic membrane to the front panel of the controller. The following artwork will help you design and create a membrane for this application. For more dimensions and guidelines, see the *Hardware & Software Setup Guide*.

Suggested End-user Overlay:

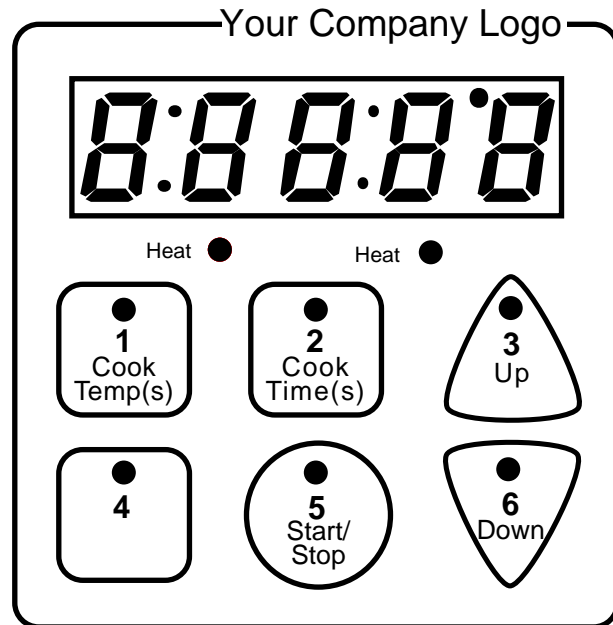

This Prototyping and Training Membrane Overlay will help you with the configuration and programming steps. To order it, see the Ordering Information at the back of this guide.

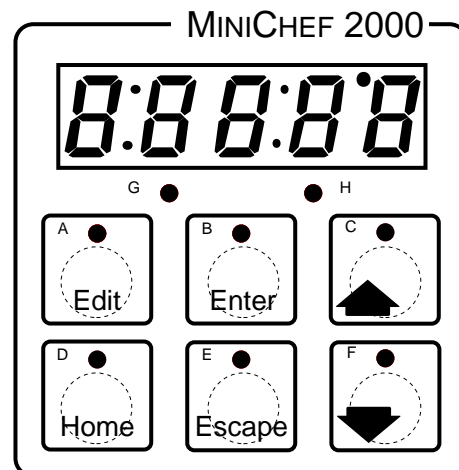

Step 8 Operate the Controller

Summary of Key Functions in Operation Mode

Key	Operation Function
A	Cook Temp
B	Cook Time
C	Up (Increment)
D	Not Used
E	Start/Stop
F	Down (Decrement)

Startup

Apply power to the griddle.

idLE will appear on the display.

If the Real-time Clock option is installed and **SETUP / CLoc** = **YES** the present time of day will appear on the display.

Set the Menu

Set the cooking temperatures.

1. Press the Cook Temp key for **TEMP 1** and then the cooking temperature value will appear on the display.
2. Press the Up-arrow or Down-arrow key until the value you want appears on the display.
3. Press the Cook Temp key again.
The cooking temperature has been set.

idLE will appear on the display.

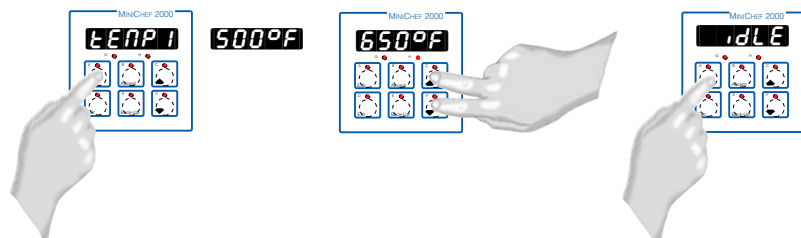

Set the cooking time.

1. Press the Cook Time key **TIME 1** and then the cooking time value will appear on the display.
2. Press the Up-arrow or Down-arrow key until the value you want appears on the display.

- Press the Cook Time key again.

The cooking time has been set.

idLE will appear on the display.

Five Second Timeout

When using the up or down keys to change a value, if you do not press any key for 5 seconds, the controller will automatically be set to the last value on the display and return to **idLE**.

Preheat

If the **rEAdy** parameter under the **SEtUP** function in the Configuration mode is set to **YES**, the controller will detect temperatures and preheat to operating temperature (above set point minus the ready band).

Note: The controller will not respond if Time1 is set to 0.

The menu you have chosen becomes the current menu for controller operation. Until the menu is completed or canceled, the indicator light above the Start/Stop key will light up (flashing or steady).

- If the griddle is not at operating temperature, it will preheat. Meanwhile:

The word **PrE- HEAt** will appear on the display for a few moments.

The menu key indicator light will flash slowly.

The temperature of Channel 1 will be displayed until the operating temperature for both channels is reached.

The heat output indicator light (G, just below the display) will light up whenever the controller is calling for heat.

When the channel is at operating temperature (set points minus the ready band) **rEAdy** will appear on the display and the Start/Stop key indicator light will flash rapidly. You are now ready to cook.

- If the griddle is at operating temperature, the display goes directly to **rEAdy** without indicating preheat or temperature.

Run a Menu (with preheat feature)

This procedure describes how to run the menu when the preheat feature is active (when the **rEAdy** parameter in the **SEtUP** function of the Configuration Mode is set to **YES**).

- Set the menu as shown earlier.
- With **idLE** or time of day on the display, press the Start/Stop key.

If the preheat condition (temperatures \geq set point minus the ready band) has not been met, the griddle will preheat until **rEAdy** appears on the display.

If the griddle is at operating temperature **rEAdy** will appear on the display.

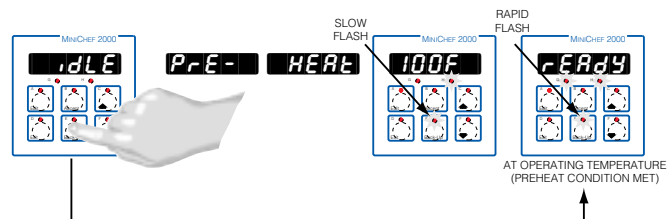

- With **rEAdy** on the display, place the food on the griddle and press the Start/Stop key (indicated by the rapidly flashing indicator light).

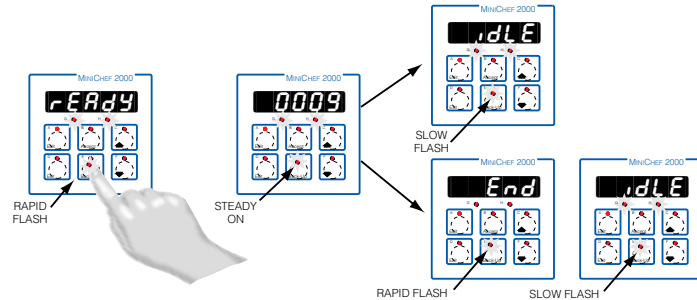

The Start/Stop indicator light will light up. Time will count down on the display.

- When the cooking cycle is finished, the controller goes into idle and the Start/Stop key indicator light will switch off. The controller will continue to regulate to the set-point.
- Remove the food from the griddle.
- To repeat cooking, repeat steps 2 through 5.

Run a Menu (without preheat feature)

This procedure describes how to run the menu when the preheat feature is inactive (when the **rEAdy** parameter in the **SEtUP** function of the Configuration Mode is set to **no**).

- Set the menu as shown earlier.
- With **idLE** or time of day on the display, press the Start/Stop key.
- The Start/Stop indicator light will light up. Time will count down on the display.

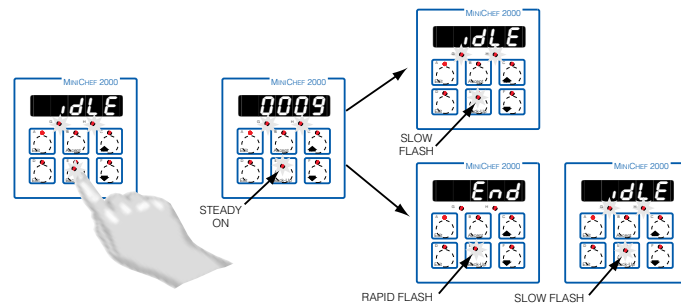

- When the cooking cycle is finished, the controller goes into idle and the Start/Stop key indicator light will switch off. The controller will continue to regulate to the set-point.
- Remove the food from the griddle.
- To repeat cooking, repeat steps 2 through 5.

Adjust a Menu While Cooking

You can adjust the temperature and time settings during the cooking and hold sequences by performing the actions shown under “Set the Menu” earlier in this section.

Changes can be made to temperature and time only during the portion of the cooking sequence in which they are active. For example: a change to the first cooking temperature **EETP1** can be made only when the first cooking temperature is being run during the cooking sequence.

Temperature changes made while cooking are saved and become part of the permanent menu. Time changes are not saved and do not become part of the permanent menu.

Cancel a Menu

Canceling a menu stops controller operation completely. The controller does not maintain set point temperatures or run time. You cancel a menu to run another menu, stop menu operation for any reason, or are preparing to shut off the griddle.

- Press the Start/Stop for 2 seconds.
Heat outputs will switch off. The heat output indicator light will switch off. **idLE** or the time of day will be on display.

Change Menus or Restart

1. If the controller is preheating or running a menu, cancel the menu by pressing and holding the Start/Stop for 2 seconds. If the controller is in **idLE** go to 2.
2. Press the key for the menu you want to run.
Based on its programming, the unit will run the menu in one of the ways described earlier.

Timer Output

If **EETYPE** / **EOUT** in the Configuration Mode is set to **YES**, when time is counting down Event Output 2 is on. It is off during **PAUSE**, **idLE** or **Hold**.

Temperature Alarms

The controller will alert you to temperature alarm conditions if they occur. If an alarm occurs, take action as determined by your supervisor. See the Appendix in the *Hardware & Software Setup Guide* for Troubleshooting Chart and a summary of temperature alarms.

Errors

The controller will alert you to errors if they occur. Errors are critical problems that shut down the unit. If an error occurs, an error message will appear on the display. You should switch off the power and call for service.

See the Appendix in the *Hardware & Software Setup Guide* for a Troubleshooting Chart and a summary of errors.

Specifications (1032)

Control Mode

- Single and dual heat channels, PID or on/off.¹
- Microprocessor-based, programmable, reverse-acting control outputs.
- User-selectable embedded application software defines operation of display, keys, inputs, outputs, timing action.
- One-step auto-tuning, WatHelp diagnostics, WatCurve temperature compensation.

Agency

- CE approved:
 - 89/336/EEC Electromagnetic Compatibility Directive
 - EN 50081-1: Emissions
 - EN 50082-1: Immunity
 - 73/23/EEC Low-Voltage Directive
 - EN 60730-1 and EN 60730-2-9: Safety
- NSF Listed, Criteria 2.⁵
- AGA: UL tested to AGA standard Z21.23, UL File #E43684.
- UL and C-UL recognized, UL 197, 873, 991 and CSA standard C22.2-24, File # E43684.

Operator Interface

- Membrane overlay, contamination and water resistant, (supplied by customer).
- LED display, 5-digit, 0.56 in high, red.
- Displays times, temperatures, user prompts and diagnostic codes.
- User-selectable time and temperature display formats.
- Temperature display formats—°F or °C.
- Time display formats—H:MM:SS, HH:MM, or MMM:SS.
- 8 discrete indicator LEDs, red.
- 6 tactile feedback keys.
- Menu-driven operation and manual modes available.
- WatHelp diagnostics.
- Real-time clock option displays time of day.

Accuracy

- Calibration accuracy and sensor conformity²: $\pm 2.0^\circ\text{F}$ for Type J thermocouple and RTD, $\pm 0.35\%$ of span for Type K and E thermocouples, ± 1 LSD, $77^\circ\text{F} \pm 5^\circ\text{F}$ ambient and rated line voltage of $\pm 10\%$.
- Accuracy span: 1000°F (540°C) minimum.
- Temperature stability: $\pm 0.15^\circ\text{F}/^\circ\text{F}$ ($0.15^\circ\text{C}/^\circ\text{C}$) change in ambient typical.

Sensors/Inputs

- Contact inputs, TTL compatible with internal pull-up resistor, two available.
- Thermocouple,³ software selectable Type J, K or E, 32 to 1200°F . (Dual-channel applications require at least one ungrounded thermocouple).
- RTD,³ 2- or 3-wire, platinum, 100, 500, 1000 Ω , at 0°C , software selectable DIN or JIS curves, 0 to 1200°F (3-wire will function as 2-wire).
- Input A/D resolution: 15 bit.

Output Options

- Solid-state relay, 0.4A, with or without contact suppression.
- Switched dc signal, 4.5V to 5.25V, 30mA maximum output, minimum load resistance $> 150\Omega$, non-isolated.

Audible Output Options

- Switched dc signal, 4.5V to 5.25V, 30mA maximum output, minimum load resistance $> 150\Omega$, non-isolated.
- Internal audible alarm, 75dB at 10 cm.

Connectors

- Sensor Input Terminal Strip⁴: RIACON, 6-position, quick-connect.
- Power Supply & Input/Output Terminal⁴: AMP, 15-position, quick-connect.

Power/Line Voltage

- 20.4 to 26.4V~ (ac), 47 to 63Hz.
- 15VA maximum.
- For CE applications, input power must be limited to 15W external to the control.
- Program retention upon power failure via non-volatile memory.
- Battery/real-time clock option: 6-year lithium battery, provides power backup upon power failure, operation resumption after power recovery, ability to display time of day.

Operating Environment

- 32 to 176°F (0 to 80°C), 0 to 90% RH, non-condensing.

Storage Temperature

- -40 to 176°F (-40 to 80°C).

Mechanical

- Case: polycarbonate Lexan with adjustable mounting collar (vertical or horizontal orientation), designed for mounting on 16-, 18-, 20- and 22-gauge panels.
- Internal panel mounting requires a specified panel cutout and four #6-32 studs or equivalent.
- Overall width x height x depth: horizontal - 4.13 in x 3.25 in x 2.00 in; vertical - 3.25 in x 4.13 in x 2.00 in (Assumes mating connectors are attached. Does not include wire bundle space requirements.).
- Vibration: 2g, 10 to 150Hz, applied in any one of three axes.
- Weight: 6.50oz maximum.

Program Storage

- All non-embedded user and factory programs are stored in non-volatile memory. Can be changed by reprogramming.

Sample/Update Rates

- 1 input: 4Hz.
- 2 inputs: 4Hz.
- PID: 1Hz.
- Control outputs: 100Hz.
- Display: 10Hz.

¹ The MINICHEF 2000 controller is to be used in systems with an external high temperature limiting device.

² Thermocouple lead resistance of 200Ω causes $< 1^\circ\text{C}$ error. RTD, 22 gauge wire will not contribute more than 0.086°F error/ft.

³ Dual channel applications require either two thermocouple sensors or two identical RTD sensor types.

⁴ For mating connector information, see Ordering Information Accessory section.

⁵ Certified for thermometer accuracy (oven and hot food holding applications from 32°F to 60°F) when used with RTD or type J thermocouple probes.

Ordering Information

(1033)

F 2 H A - 1 - A A

MINICHEF™ 2000

Cooking controller with numerous food equipment application software sets, single and dual channel on/off or PID temperature regulation, timer and machine-function control, microprocessor-based, programmable, auto-tuning, WatCurve, WatHelp diagnostics, 24V~ (ac) power input, agency approved, flush mounted (membrane faceplate supplied by customer).

Inputs

- 1 = Dual thermocouple, Type J, K or E
- 2 = Dual RTD, platinum, 100Ω, curve selectable
- 3 = Dual RTD, platinum, 500Ω, curve selectable
- 4 = Dual RTD, platinum, 1000Ω, curve selectable

Note: All models include two event inputs, switched dc logic signal, non-isolated.

Output Number 1

- 1 = Switched dc, 5V nominal, 30mA, non-isolated
- 2 = Solid-state relay, Form A, 0.4A, without RC suppression
- 3 = Solid-state relay, Form A, 0.4A, with RC suppression

Output Number 2

- 1 = Switched dc, 5V nominal, 30mA, non-isolated
- 2 = Solid-state relay, Form A, 0.4A, without RC suppression
- 3 = Solid-state relay, Form A, 0.4A, with RC suppression

Event Outputs 1 and 2

- 1 = 2 event outputs, switched dc, 5V nominal, 30mA, non-isolated

Battery and Real-time Clock

- 0 = None
- 1 = Includes battery and real-time clock

Audible Alarm

- 0 = Alarm signal available at connector, switched dc, 5V nominal, 30mA, non-isolated
- 1 = Internal alarm included

Software

- AA = Standard Food Equipment Application Software Set
- XX = Custom Set-up parameters or Made-To-Order custom software. Consult your local Watlow Sales Engineer. Code number assigned by factory.

Ordering Information: Part Numbers & Accessories

MINICHEF 2000 Accessories

0836-0442-0000	Sensor Input Mating Connector, (RIACON #31007106), 6-position, quick-connect terminal, screw connection for 28-14 AWG wires, tighten to 7 in/lb
A001-0298-0000	Power Supply and I/O Mating Connector Kit. Includes: – 1 AMP #1-640523-0, 15-position, quick-connect terminal – 15 AMP #641300-1 crimp pins
0238-0679-0000	Prototyping & Training Membrane Overlay, adhesive-backed, 4.75 in x 4.75 in
0830-0479-0000	Prototyping EPROM Extraction Tool, AMP #821980-1
A001-0249-0001	120V~ to 24V~ (ac), stepdown transformer, class 2, quick-connect terminals included
A001-0249-0002	208/240V~ to 24V~ (ac), step-down transformer, class 2, quick-connect terminals included

MINICHEF 2000 Documentation

WMC2-XUGN-0000	The Complete MINICHEF 2000 User Guide
WMC2-XADN-0000	The Complete MINICHEF 2000 User Guide on CD
WMC2-XTDN-0000	MINICHEF 2000 Tutorial Disk
WMC2-XSGN-0000	Hardware & Software Setup Guide
WMC2-XAGN-0001	Cook & Hold Oven Application Guide
WMC2-XAGN-0002	Convection Oven Application Guide
WMC2-XAGN-0003	Deepfat Fryer Application Guide
WMC2-XAGN-0004	Griddle Application Guide
WMC2-XAGN-0005	Timer Application Guide
WMC2-XAGN-0006	Shelf-Timer Application Guide
WMC2-XAGN-0007	Rotisserie Oven Application Guide

Recommended Sources of Supply for Miscellaneous Items

DURA-TECH, Inc. LaCrosse, WI (608) 781-2570	• <i>Custom Membrane Faceplates</i>
AMP, Inc. Harrisburg, PA 1-800-522-6752	• <i>Prototyping EPROM Extraction Tool</i> Part No. 821980-1 • <i>Pin Crimping Hand Tools</i> Part No. 90325-1 or 58514-1 • <i>Pin Extraction Hand Tool</i> Part No. 455822-2
RIA Electronic, Inc. Eatontown, NJ (908) 389-1300	• <i>RIACON Connectors</i>

Watlow Controls

Watlow Controls is a division of Watlow Electric Mfg. Co., St. Louis, Missouri, a manufacturer of industrial electric heating products since 1922. Watlow begins with a full set of specifications and completes an industrial product that is manufactured totally in-house, in the U.S.A. Watlow products include electric heaters, sensors, controls and switching devices. The Winona operation has been designing solid state electronic control devices since 1962, and has earned the reputation as an excellent supplier to original equipment manufacturers. These OEMs depend upon Watlow Controls to provide compatibly engineered controls that they can incorporate into their products with confidence. Watlow Controls resides in a 100,000-square-foot marketing, engineering and manufacturing facility in Winona, Minnesota.

Technical Assistance

If you encounter a problem with your Watlow controller, refer to the Troubleshooting Chart in this guide. Also review all of your configuration information for each step of the setup to verify that your selections are consistent with your applications.

If the problem persists after checking all the steps, you can get technical assistance by calling Watlow Controls at (507) 454-5300, between 7 a.m. and 5 p.m. CST, and asking for an applications engineer. When you call have the following information on hand: the controller's part number, date code, serial number, software revision number, and application number. Much of this information is available on the controller case. All of this information is also available via the MINICHEF 2000 main display by accessing the WatHelp Diagnostics Function under **d,189** in the Configuration Mode.

We Value Your Feedback

Your comments and suggestions on this manual are welcome. Please send them to, Technical Writer, Watlow Controls, 1241 Bundy Blvd., P.O. Box 5580, Winona, MN 55987-5580 or call (507) 454-5300 or fax (507) 452-4507.

Contact

- Phone: (507) 454-5300.
- Fax: (507) 452-4507.
- For technical support, ask for an Applications Engineer.
- To place an order, ask for Customer Service.
- To discuss a custom option, ask for the MINICHEF 2000 Product Manager.

Warranty

The MINICHEF 2000 is warranted to be free of defects in material and workmanship for 36 months after delivery to the first purchaser for use, providing that the unit has not been misapplied. Since Watlow has no control over its use, or misuse, we cannot guarantee against failure. Watlow's obligations hereunder, at Watlow's option, are limited to replacement or refund of purchase price of a unit which upon examination proves to be defective within the warranty period. This warranty does not apply to damage resulting from transportation, alteration, misuse, or abuse.

Returns

- Call or fax Customer Service for a Return Material Authorization (RMA) number before returning a control.
- Put the RMA number on the shipping label, and also on a description of the problem.
- 20% of net price restocking charge applies to all standard units returned to stock.

Note: All documentation of the MINICHEF 2000 is subject to change without notice.

Notes

Watlow MINICHEF™ 2000 Griddle Applications Guide

Watlow Controls, 1241 Bundy Blvd., P.O. Box 5580, Winona, MN U.S.A. 55987-5580 Phone: (507) 454-5300, Fax: (507) 452-4507