

MINICHEF™ 2000

Applications 10 - 19

Deepfat Fryer Applications Guide

Programming & Operating Steps



Watlow Controls

1241 Bundy Blvd.
P.O. Box 5580
Winona, Minnesota U.S.A. 55987-5580
(507) 454-5300, Fax (507) 452-4507

CE 97

TOTAL
CUSTOMER
SATISFACTION

ISO 9001



WMC2-XAGN-0003-Rev A
May 1997

\$5.00
Made in the U.S.A.

Table of Contents



<i>Application 10</i> <i>Automatic Deepfat Fryer with Autolift Control</i>	<i>1</i>
<i>Application 11</i> <i>Automatic Deepfat Fryer with Autolift Control</i>	<i>11</i>
<i>Application 12</i> <i>Manual Deepfat Fryer with Autolift Control</i>	<i>23</i>
<i>Application 13</i> <i>Pressurized Automatic Deepfat Fryer</i>	<i>35</i>
<i>Application 14</i> <i>Pressurized Automatic Deepfat Fryer</i>	<i>45</i>
<i>Application 15</i> <i>Pressurized Manual Deepfat Fryer</i>	<i>55</i>
<i>Application 16</i> <i>Automatic Deepfat Fryer</i>	<i>65</i>
<i>Application 17</i> <i>Automatic Deepfat Fryer</i>	<i>75</i>
<i>Application 18</i> <i>Automatic Deepfat Fryer</i>	<i>83</i>
<i>Application 19</i> <i>Manual Deepfat Fryer</i>	<i>95</i>
<i>Ordering Information</i>	<i>106</i>

Application 10

Automatic Deepfat Fryer with Autolift Control

Single Heat Channel, Four Menus

<i>Introduction to Application 10</i>	<i>1</i>
<i>Configuration Mode Quick Reference</i>	<i>3</i>
<i>Program Mode Quick Reference</i>	<i>4</i>
<i>Step 7 Design a Faceplate Overlay</i>	<i>5</i>
<i>Step 8 Operate the Controller</i>	<i>6</i>

Application 10 allows you to program as many as four menu keys, each of which can control one heat channel, one cooking time, a mid-point alarm and autolift capability. The application includes up to four menus that control fryer temperatures and cooking time.

Overview of Key Steps

1. Install the MINICHEF 2000.
2. Wire the controller.
3. Configure the controller.
4. Program the menus.
5. Set the controller security.
6. Set the Real-time Clock.

For instructions on Steps 1, 2, 3, 4, 5 and 6, see the *Hardware & Software Setup Guide*.

7. Design, manufacture and apply faceplate overlay for end-users. (For a suggested design to suit this application, see this section. For overlay dimensions and guidelines, see the *Hardware & Software Setup Guide*.)
8. Operate the controller. (See this application guide.)

Key Functions in Configuration Mode



Key Functions in Operation Mode

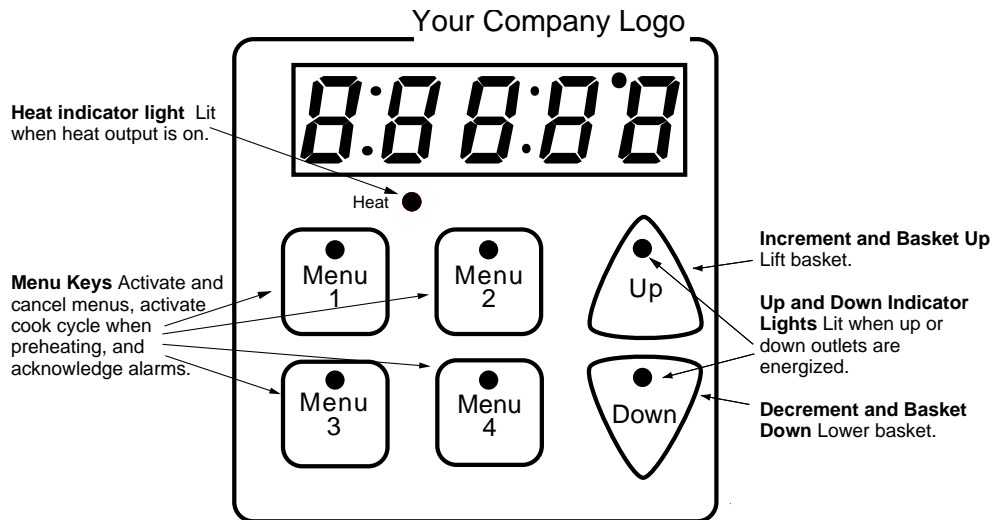

WARNING: The Basket Up and Basket Down Keys cause or initiate motion. Appropriate reasonable care should be taken to prevent personal injury or machine damage as a result of operator initiated or unexpected machine motion.

Summary of Input/Output Functions

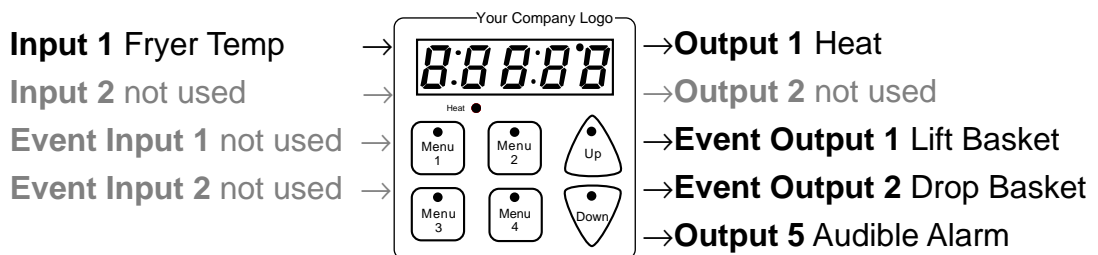

Note: For details, see wiring instructions in the *Hardware & Software Setup Guide*.

Configuration Mode Quick Reference

These are the functions, parameters and values included in the Configuration Mode for this application. You must select Application 10 to access them. For directions, see the *Hardware & Software Setup Guide*. The Appendix of that guide includes an explanation of all parameters and values.

Function	Parameter	Value	Your settings
ETYPE Equipment-Type	APPL Application Number	1 - 28	10
	A_Loc Application Number Security Lock	Yes, No	
	Sound Audible Alarm	0 - 5	
	btime Basket Travel Time	0 - 30 seconds	
	PREHE Initial Preheat	Range low to range high	
	MELT Oil Melt Cycle	On, Off	
	°C or °F		
SETUP Setup	TCF Temperature Display Format	°C or °F	
	TIME Time Display Format	MMM:SS, HH:MM, H:MM:SS	
	Chirp Key Chirp	On, Off	
	Loc Menu Security Lock	Yes, No	
	tc Thermocouple Type	J, K (shown as H), E	
	rtd RTD Curve	DIN, JIS	
	tcconP WatCurve™ Temperature Compensation	On, Off	
	Offset1 Temperature Offset, Channel 1	-99 to 99°F (-55 to 55°C)	
	ErLo Temperature Range Low	0° F (-18° C) for RTD inputs, 32°F (0°C) for tc inputs to ErHi	
	ErHi Temperature Range High	ErLo to 1200°F (649°C)	
	rERdy Preheat Ready Feature	Yes, No	
	rbrnd Ready Band	1 to 1200°F (649°C)	
	CLoc Real Time Clock Display	Yes, No	
	PLoss Power Loss Menu Resume	Yes, No	
	AL1 Alarms for Channel 1	None, Dev, Proc, Both	
	ALP1 Absolute Process Alarm 1	100 to 1200°F (649°C)	
	ALdL1 Low Deviation Alarm 1	-999 to 0°F (-555 to 0°C)	
ALdH1 High Deviation Alarm 1	0 to 999°F (0 to 555°C)		
ThERL Thermal	TYPE Type of Temperature Control	PID, On-Off	
	HYSL1 Hysteresis 1*	1 to 99°F (1 to 55°C)	
	PidU PID Units	SI, US	
	tunE1 Auto-tuning 1	on, OFF	
	PROP1 Proportional Band 1	1 to 999°F (1 to 555°C)	
	rSEt1 Reset (integral) Gain 1**	0.00 to 9.99 repeats/minute	
	int1 Integral Gain 1	0.00 to 99.99 minutes/repeat	
	rAtE1 Rate (derivative) Gain 1**	0.00 to 9.99 minutes	
	dEr1 Derivative Gain 1	0.00 to 9.99 minutes	
	Cycl1 PID Cycle Time 1	1 to 60 seconds	

d.A9 WatHelp Diagnostics Used for equipment troubleshooting and testing. Not used when programming. See the *Hardware & Software Setup Guide*.

*Note: Available only when controller is on/off.

**Note: Available only when PID units are set to US.

Program Mode Quick Reference

These are the functions, parameters and values included in the Program Mode for this application. You must select Application 10 to access them. For menu programming directions, see the *Hardware & Software Setup Guide*. The Appendix of that guide includes a detailed explanation of all parameters and values.

Function	Parameter	Value	Your Settings
99 Menu Numbers 1 - 4	SETP1 Set point 1 Temperature of channel 1.	Format varies based on configuration.	
	TME1 Time 1 Menu run time.	Format varies based on configuration. Setting at 0 invalidates selected menu.	
	ALARM Mid-menu alarm setting.	Stir, Add, FLIP, Turn, ALERt, NonE	
	ALnE Mid-menu alarm time.*	0 to TME1 .	

*Note: Applies only when the alarm is not set to **nonE**.

Auto-tuning note:

Before auto-tuning Application 10, Set Point 1 of Menu 1 must first be set to a value that is typical of your application. (See the *Hardware & Software Setup Guide* for information on programming menus.) Then set **THErL / tUNE1** to **on**. After you accept this **on** setting, the display will present **tUNE** when the auto-tuning is taking place.

The controller will cancel the auto-tuning process if it cannot be completed in 80 minutes. You can cancel the auto-tuning process at any time by pressing either key C or Key D and accepting **OFF** when it appears.

Step 7 Design a Faceplate Overlay

To complete the installation, you must apply a graphic membrane to the front panel of the controller. The following artwork will help you design and create a membrane for this application. For more dimensions and guidelines, see the *Hardware & Software Setup Guide*.

Suggested End-user Overlay:

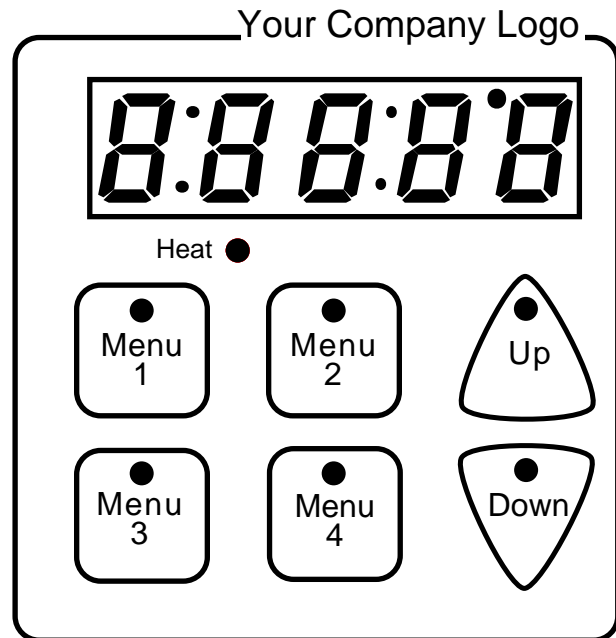

This Prototyping and Training Membrane Overlay will help you with the configuration and programming steps. To order it, see the Ordering Information at the back of this guide.

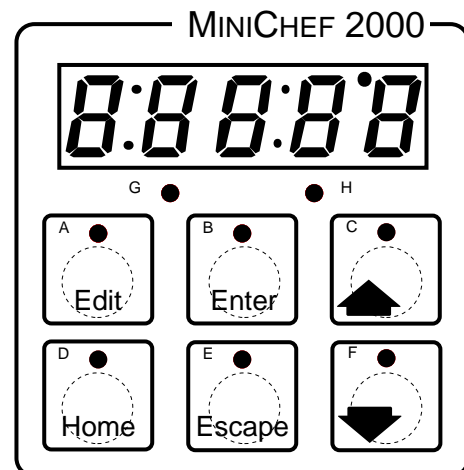

Step 8 Operate the Controller

Summary of Key Functions in Operation Mode

Key	Function
A	Menu 1
B	Menu 2
C	Basket up
D	Menu 3
E	Menu 4
F	Basket down

Startup

Apply power to the fryer and add cooking oil if necessary.

Initial Preheat

At power-up, the unit will preheat to the temperature value set in the Configuration Mode **TEMP** / **PREHEAT**. The display will show **PRE-HEAT** followed by oil temperature as the oil heats up.



When the unit reaches initial preheat temperature, **rEAdy** will flash once on the display and an audible tone will sound for 2 seconds. Then **idLE** will appear on the display. If the Real-time Clock option is installed and **SETUP / CLocK** is set to **YES**, the time of day will appear on the display.

If the preheat condition is met before power-up, the controller goes directly to idle, and does not display **rEAdy** or sound an audible tone.

Preheat

If in the Configuration Mode **SETUP / rEAdy** has been set to yes, the controller will detect temperatures and preheat to operating temperature (above relative set point minus the ready band) as required.

- Activate the menu by pressing the Start/Stop key.

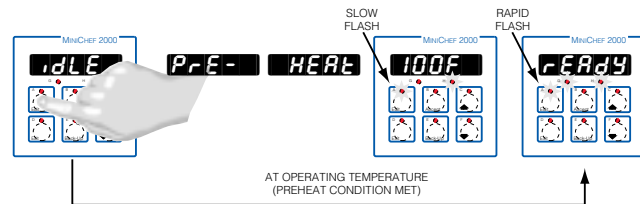

If the fryer is not at operating temperature, it will preheat. Meanwhile:

The word **PRE-HEAT** will appear on the display for a few moments. The

Start/Stop key indicator light will flash slowly. The temperature of Channel 1 will be displayed until the operating temperature is reached.

The heat output indicator light - G, just below the display- will light up whenever the controller is calling for heat.

When the fryer is at operating temperature (above relative set point minus the ready band) **rEAdy** will appear on the display and the Start/Stop key indicator light will flash rapidly. You are now ready to cook with the active menu.

If the fryer is at operating temperature, the display goes directly to **rEAdy** without indicating preheat or temperature.

The Melt Cycle

To avoid burning congealed oil (shortening), a slow heating action may be necessary. If this is desired, be sure that in the Configuration Mode **ELyPE** / **rTtELt** has been set to **on**. Then, when the oil temperature is below 212 °F the heat output will be limited to 10% of full power. This reduces the chance of burning congealed oil while it is heating.

Run a Menu (with preheat feature)

This procedure describes how to run an active menu when the preheat feature is inactive — in other words, when the **rEAdy** parameter in the **SEtUP** function of the Configuration Mode is set to **YES**.

1. With **idle** on the display (or time of day displayed if available), press the key for the menu you want to run.

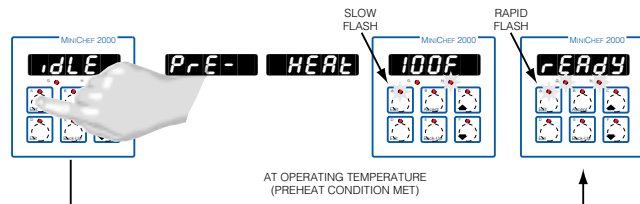

If the selected menu's preheat condition (setpoint minus the ready band) has not been met, the fryer will preheat until **rEAdy** appears on the display. If the fryer is at operating temperature **rEAdy** will immediately appear on the display.

2. With **rEAdy** on the display, place the food in the basket and press the action menu key (indicated by the flashing red light.) The menu key indicator light will light up, the basket will lower automatically. Time will count down on the display.

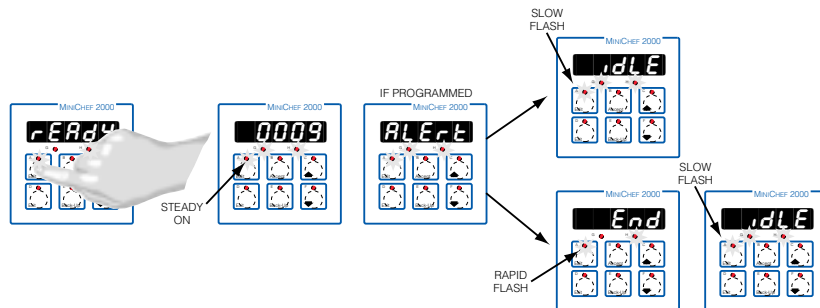

3. If programmed, as the time counts down, a mid-menu alarm message will appear on

the display. (The message, which varies based on programming at **P7** / **ALARM** will appear for ten seconds.)

An audible tone will sound for five seconds. Time will continue to count down on the display.

- When the cooking cycle is finished the basket will rise automatically. One of the following will happen, depending on the way the controller was programmed at **ETYPE** / **Sound**:

With Sound set to 0: The controller automatically switches to idle, where the controller maintains the temperatures at set point and does not run time. **idle** or time of day will appear on the display. The menu key indicator light will flash slowly.

With Sound set to 1, 2, or 3, **End** will appear on the display and an audible tone will be emitted. The menu key indicator light will flash rapidly. You can acknowledge and silence the tone by pressing the active menu key or it will time out in 1 to 20 seconds and go into idle. The menu key indicator light will flash slowly.

With Sound set to 4 or 5, **End** will appear on the display and the menu key indicator light will flash rapidly. You must acknowledge the audible tone by pressing the active menu key. Once acknowledged, the tone is silenced and the controller goes into idle. The menu key indicator light will flash slowly.

- Remove the food from the basket. The controller will continue to regulate to the last set point. The menu key indicator light will flash slowly.
- To repeat cooking, repeat steps 1 through 5.

Run a Menu (without preheat feature)

This procedure describes how to run a menu when the preheat function is inactive — that is, when the **READY** parameter in the **SETUP** function of the Configuration Mode is set to **no** — and initial preheat power-up has been completed.

- With **idle** on the display, place the food in the basket.

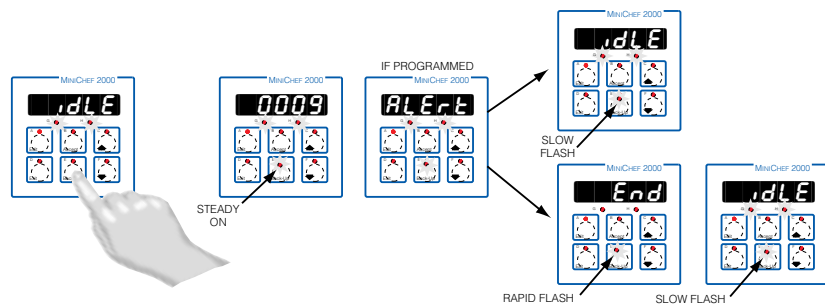

- Press the key for the menu you want to run. The menu key will light up, the basket will lower automatically, and then time will count down on the display.:
- If programmed, as the time counts down, a mid-menu alarm message **P7** / **ALARM** will appear on the display.

The alarm message, which varies based on programming, will appear for ten seconds.

An audible tone will sound for five seconds. Time will continue to count down on the display.

- When the cooking cycle is finished, the basket will rise automatically. One of the fol-

lowing will happen, depending on the way the controller was programmed at **ETYPE / Sound**:

With Sound set to 0: The controller automatically switches to idle, where the controller maintains the temperatures at set point and does not run time. **idLE** or time of day will appear on the display. The menu key indicator light will flash slowly.

With Sound set to 1, 2, or 3: **End** will appear on the display and an audible tone will be emitted. The menu key indicator light will flash rapidly. You can acknowledge and silence the tone by pressing the active menu key or it will time out in 1 to 20 seconds and go into idle. The menu key indicator light will flash slowly.

With Sound set to 4 or 5: **End** will appear on the display and the menu key indicator light will flash rapidly. You must acknowledge the audible tone by pressing the active menu key. Once acknowledged the tone is silenced and the controller goes into idle. The menu key indicator light will flash slowly.

- 5 Remove the food from the basket. The controller will continue to regulate at the last set point. The menu indicator light will flash slowly.
6. To repeat cooking, repeat steps 1 through 5.

Cancel a Menu

Canceling a menu stops controller operation completely. The controller does not maintain set point temperatures or run time. Users may cancel a menu in order to run another one, to stop menu operation for any reason, or when preparing to shut off the fryer.

- Press the active menu key for 2 seconds.

Heat outputs will switch off. Heat output indicator lights will switch off. The display presents **idLE** or the time of day will appear on the display.

Change or Restart Menus

- With the controller in idle, press the key for the menu you want to run.

Manual Basket Lift

You can raise or lower the basket manually at any time by pressing the Down-arrow key (to lower) or the Up-arrow key (to raise). If you raise the basket while cooking, the timer will pause. Countdown time will resume when you lower the basket or when you press the active menu key.



WARNING: The Basket Up and Basket Down Keys cause or initiate motion. Appropriate reasonable care should be taken to prevent personal injury or machine damage as a result of operator initiated or unexpected machine motion.

Event Outputs

While running a menu:

Event output 1 is activated to lift the basket for the length of time programmed in Configuration Mode **ETYPE / bt.nE**.

Event output 2 is activated to lower the basket for the length of time programmed in Configuration Mode **ETYPE / bt.nE**.

Only one output can be on at a time.

Temperature Alarms

The controller will alert you to temperature alarm conditions if they occur. If an alarm occurs, take action as determined by your supervisor. See the Appendix in the *Hardware & Software Setup Guide* for a Troubleshooting Chart and a summary of temperature alarms.

Errors

The controller will alert you to errors if they occur. Errors are critical problems that shut down the unit. If an error occurs, an error message will appear on the display. You should switch off the power and call for service.

See the Appendix in the *Hardware & Software Setup Guide* for a Troubleshooting Chart and a summary of errors.

Application 11

Automatic Deepfat Fryer with Autolift Control

Single Heat Channel, 40 Menus

<i>Introduction to Application 11</i>	<i>11</i>
<i>Configuration Mode Quick Reference</i>	<i>13</i>
<i>Program Mode Quick Reference</i>	<i>14</i>
<i>Step 7 Design a Faceplate Overlay</i>	<i>15</i>
<i>Step 8 Operate the Controller</i>	<i>16</i>

Application 11 is designed for the operation of a deep fat fryer. It includes one heat channel, one cooking time, a mid-point alarm and autolift capability. The application includes up to forty menus that control fryer temperatures and cooking time.

Overview of Key Steps

1. Install the MINICHEF 2000.
 2. Wire the controller.
 3. Configure the controller.
 4. Program the menus.
 5. Set the controller security.
 6. Set the Real-time Clock.
- For instructions on Steps 1, 2, 3, 4, 5 and 6, see the *Hardware & Software Setup Guide*.
7. Design, manufacture and apply faceplate overlay for end-users. (For a suggested design to suit this application, see this section. For overlay dimensions and guidelines, see the *Hardware & Software Setup Guide*.)
 8. Operate the controller. (See this application guide.)

Key Functions in Configuration Mode



Key Functions in Operation Mode

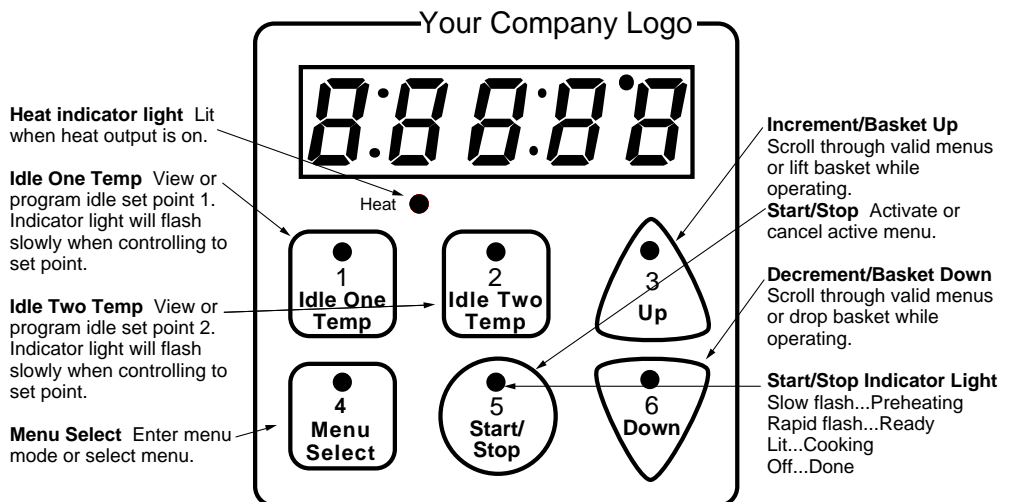

WARNING: The Basket Up and Basket Down Keys cause or initiate motion. Appropriate reasonable care should be taken to prevent personal injury or machine damage as a result of operator initiated or unexpected machine motion.

Summary of Input/Output Functions

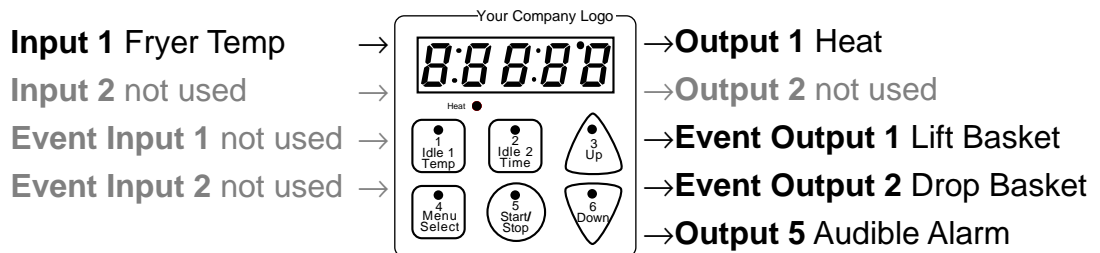

Note: For details, see wiring instructions in the *Hardware & Software Setup Guide*.

Configuration Mode Quick Reference

These are the functions, parameters and values included in the Configuration Mode for this application. You must select Application 11 to access them. For directions, see the *Hardware & Software Setup Guide*. The Appendix of that guide includes an explanation of all parameters and values.

Function	Parameter	Value	Your Settings	
ETYPE Equipment-Type	APPL Application Number	1 - 28	11	
	A_Loc Application Number Security Lock	Yes, No		
	Sound Audible Alarm Sound	0 - 5		
	bt trE Basket Travel Time	0 - 30 seconds		
	idLE1 Channel 1 Idle Temperature	Temperature range low to range high		
	idLE2 Channel 2 Idle Temperature	Temperature range low to range high		
	OMELE Oil Melt Temperature	On, Off		
	SETUP Setup	C_F Temperature Display Format		°C or °F
		E_TME Time Display Format		MMM:SS, HH:MM, H:MM:SS (H=Hours, M=Minutes, S=Seconds)
		ChirP Key Chirp		On, Off
		Loc Menu Security Lock		Yes, No
tc Thermocouple Type		J, K (shown as H), E		
rtD RTD Curve		DIN, JIS		
tcOnP WatCurve™ Temperature Compensation		On, Off		
OFFSE1 Temperature Offset, Channel 1		-99 to 99°F (-55 to 55°C)		
tr Lo Temperature Range Low		0°F (-18° C) for RTD inputs, 32°F (0°C) for tc inputs to tr HI		
tr HI Temperature Range High		tr Lo to 1200°F (649°C)		
rEADY Preheat Ready Feature		Yes, No		
rbRNd Ready Band		1 to 1200°F (649°C)		
CLoc Real Time Clock Display		Yes, No		
PLOSS Power Loss Menu Resume		Yes, No		
ETHERL Thermal		AL Alarms for channel 1	None, Dev, Proc, Both	
	AL P1 Absolute Process Alarm 1	100 to 1200°F (38° to 649°C)		
	ALdL1 Low Deviation Alarm 1	-999 to 0°F (-555 to 0°C)		
	ALdH1 High Deviation Alarm 1	0 to 999°F (0 to 555°C)		
	TYPE Temperature Control Type	PID, On-Off		
	HYSLE1 Hysteresis 1	1 to 99°F (1 to 55°C)		
	P_id U PID Units	SI, US		
	tunE1 Auto-tuning 1	on, OFF		
	ProP1 Proportional Band 1	1 to 999°F (1 to 555°C)		
	rSEt1 Reset (integral) Gain 1	0.00 to 9.99 repeats/minute		
d.A9 WatHelp Diagnostics	int 1 Integral Gain 1	0.00 to 99.99 minutes/repeat		
	rAtE1 Rate (derivative) Gain 1	0.00 to 9.99 minutes		
	dEr 1 Derivative Gain 1	0.00 to 9.99 minutes		
	CYcL1 PID Cycle Time 1	1 to 60 seconds		
		Used for equipment troubleshooting and testing. Not used when programming. See the <i>Hardware & Software Setup Guide</i> ..		

Program Mode Quick Reference

These are the functions, parameters and values included in the Program Mode for this application. You must select Application 11 to access them. For menu programming directions, see the *Hardware & Software Setup Guide*. The Appendix of that guide includes a detailed explanation of all parameters and values.

Function	Parameter	Value
PF -- Menu Numbers 1 - 40	SETP1 Set point 1 Temperature for set point 1	Temperature range low to range high
	TIME1 Time 1 Run time of set point 1	Setting Time 1 to 0 invalidates selected menu. Format varies based on configuration.
	ALARM Mid-menu alarm setting	Stir, Add, Flip, Turn, Alert, None
	ALTIME Mid-menu alarm time (not visible when alarm set to None)	0 to Time 1

Auto-tuning note:

Before auto-tuning Application 11, Setpoint 1 must first be set to a value that is typical of your application. (See the *Hardware & Software Setup Guide* for information on programming menus.) Then set **TEMP1** / **TUNE1** to **on**. After you accept this **on** setting, by pressing “Enter,” the display will present **TUNE** when the auto-tuning is taking place.

The controller will cancel the auto-tuning process if it cannot be completed in 80 minutes. You can cancel the auto-tuning process at any time by pressing either key C or Key D and accepting **OFF**, by pressing “Enter,” when it appears.

Step 7 Design a Faceplate Overlay

To complete the installation, you must apply a graphic membrane to the front panel of the controller. The following artwork will help you design and create a membrane for this application. For more dimensions and guidelines, see the *Hardware & Software Setup Guide*.

Suggested End-user Overlay:

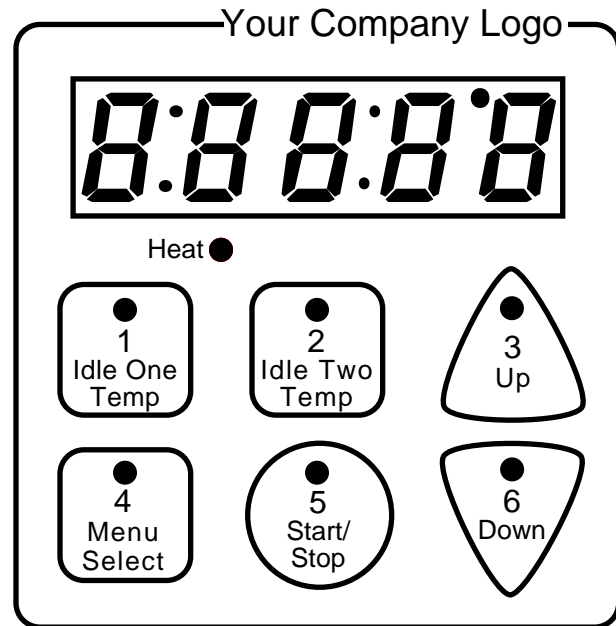

This Prototyping and Training Membrane Overlay will help you with the configuration and programming steps. To order it, see the Ordering Information at the back of this guide.

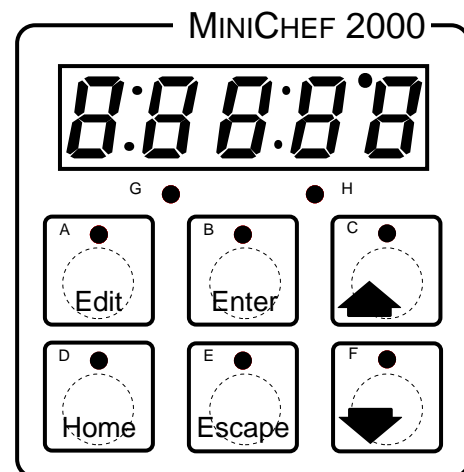

Step 8 Operate the Controller

Summary of Key Functions in Operation Mode

Key	Operation Function
A	Idle Temperature Number One
B	Idle Temperature Number Two
C	Increment and Basket Up
D	Menu Select
E	Start/Stop
F	Decrement and Basket Down

Start-up

Apply power to the fryer and add cooking oil if necessary.

Select a Menu

1. Press the Menu Select key.

The controller will display the currently selected menu. If no menus have been programmed the word **none** will appear on the display.

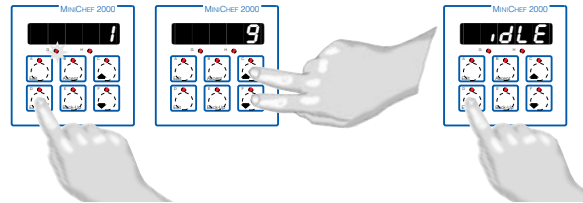

2. Press the Up-arrow or Down-arrow key until the menu you want appears on the display.

The controller will only display valid menus (those for which Time 1 for the menu is set to greater than 0).

3. Press the Menu Select key again.

The menu you have chosen becomes the current menu for controller operation.

Initial Preheat

At power-up, the unit will preheat to the temperature value set in the Configuration Mode **TYPE / PREHEAT**. The display will show **PRE- HEAT** followed by oil temperature as the oil heats.



When the unit reaches initial preheat temperature, **READY** will flash once on the display and an audible tone will sound for 2 seconds. Then **idle** will appear on the display. If Real Time Clock option is installed and **SETUP / CLoc** is set to **YES**, the time of day will appear on the display.

Preheat

If in the Configuration Mode **SETUP / READY** has been set to yes, the controller will detect temperatures and preheat to operating temperature (above relative set point minus the ready band) as required.

- Activate the menu by pressing the Start/Stop key.

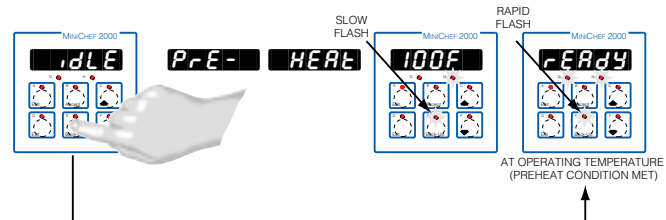

If the fryer is not at operating temperature, it will preheat. Meanwhile:

The word **PRE- HEAT** will appear on the display for a few moments. The Start/Stop key indicator light will flash slowly. The temperature of Channel 1 will be displayed until the operating temperature is reached.

The heat output indicator light - G, just below the display- will light up whenever the controller is calling for heat.

When the fryer is at operating temperature (above relative set point minus the ready band) **READY** will appear on the display and the Start/Stop key indicator light will flash rapidly. You are now ready to cook with the active menu.

If the fryer is at operating temperature, the display goes directly to **READY** without indicating preheat or temperature.

The Melt Cycle

To avoid burning, congealed oil requires a slow heating action. If, in the Configuration Mode, **TYPE / MELT** has been set to on, when the oil temperature is below 212°F the heat output will be limited to 10% of full power.

Run a Menu (with preheat feature)

This procedure describes how to run an active menu when the preheat feature is inactive — in other words, when the **READY** parameter in the **SETUP** function of the Configuration Mode is set to **YES**.

1. Select the menu you want to run as shown earlier in “Select a Menu”.
2. With **idle** or time of day on the display, press the Start/Stop key.

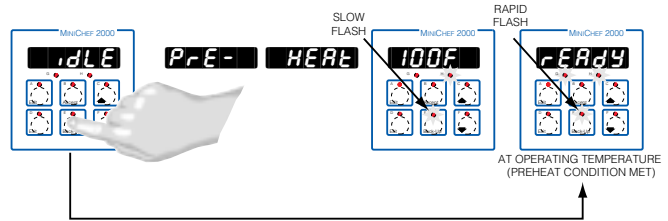

If the preheat condition has not been met, the fryer will preheat until **rEAdy** appears on the display. If the fryer is at operating temperature **rEAdy** will immediately appear on the display.

3. With ready on the display, place the food in the basket.

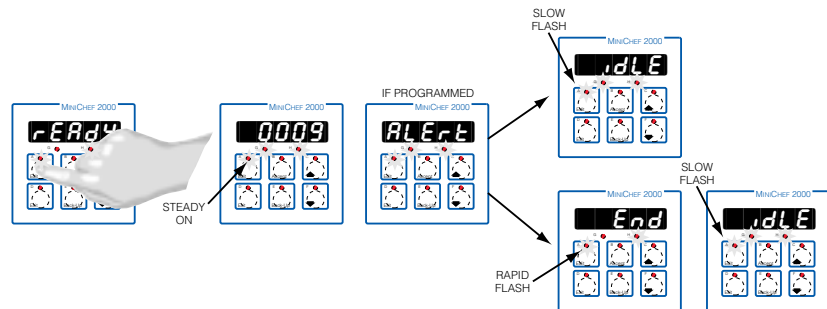

4. Press the Start/Stop key. The basket will lower automatically for the amount of time set in the Configuration Mode under **ETyPE** / **bEtInE**.
The Start/Stop key indicator light will light up. Time will count down on the display.
5. If programmed, as the time counts down, a mid-point alarm will appear on the display.
The alarm messages which varies based on programming will appear for ten seconds.
An audible will sound for five seconds. Time will continue to count down on the display.
6. When the cooking cycle is finished one of the following will happen, depending on the way the controller was programmed at **ETyPE** / **Sound**:

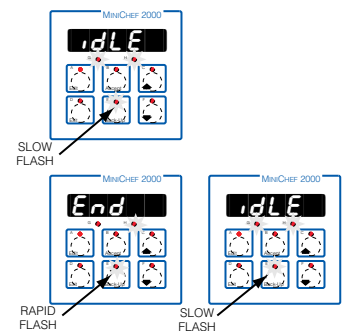

With Sound set to 0: The controller automatically switches to idle. **idle** or current time will appear on the display. The Start/Stop key indicator light will flash slowly. The controller will maintain temperature at the programmed set point.

With Sound set to 1, 2, or 3: **End** will appear on the display and an audible tone will be emitted. The Start/Stop key indicator light will flash rapidly. You can acknowledge and silence the tone by pressing the Start/Stop key or it will automatically time out within 2 seconds for setting 1 or 20 seconds for settings 2 or 3 and then go into idle. The Start/Stop key indicator light will flash slowly. The controller will maintain temperature at the programmed set point.

With sound set to 4 or 5: **Alert** will appear on the display and the Start/Stop key indicator light will flash rapidly. You must acknowledge the audible tone by pressing the Start/Stop key. Once acknowledged the audible tone is silenced and the controller goes into idle. The Start/Stop key indicator light will flash slowly. The controller will maintain temperature at the programmed set point.

7. The basket will raise automatically based on the value programmed in the Configuration Mode **ETYPE** / **bt inE**.
8. To repeat cooking, repeat steps 1 through 7.

Run a Menu (with no preheat feature)

This procedure describes how to run an active menu when the preheat feature is inactive - in other words, when the **ready** parameter in the **SETUP** function of the Configuration Mode is set to **no**.

1. Select the menu you want to run as shown earlier in "Select a Menu".
2. With **idle** or time of day on the display, place the food in the basket.

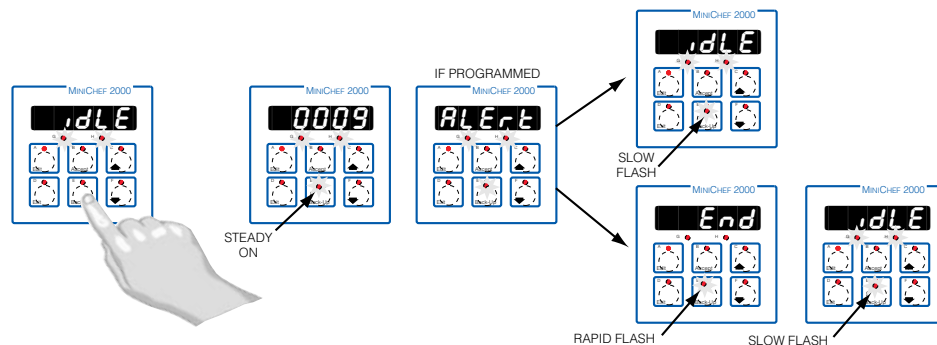

3. Press the Start/Stop key. The basket will lower automatically for the amount of time set in the Configuration Mode under **ETYPE** / **bt inE**.

The Start/Stop key indicator light will light up. Time will count down on the display.

4. If programmed, as the time counts down, a mid-point alarm will appear on the display.

The alarm message which varies based on programming will appear for ten seconds.

An audible will sound for five seconds. Time will continue to count down on the display.

5. When the cooking cycle is finished one of the following will happen, depending on the way the controller was programmed at **ETYPE** / **Sound**:

With Sound set to 0: The controller automatically switches to idle. **idle** or cur-

rent time will appear on the display. The Start/Stop key indicator light will flash slowly. The controller will maintain temperature at the programmed set point.

With Sound set to 1, 2, or 3: **End** will appear on the display and an audible tone will be emitted. The Start/Stop key indicator light will flash rapidly. You can acknowledge and silence the tone by pressing the Start/Stop key or it will automatically time out within 2 seconds for setting 1 or 20 seconds for settings 2 or 3 and then go into idle. The Start/Stop key indicator light will flash slowly. The controller will maintain temperature at the programmed set point.

With sound set to 4 or 5: **End** will appear on the display and the Start/Stop key indicator light will flash rapidly. You must acknowledge the audible tone by pressing the Start/Stop key. Once acknowledged the audible tone is silenced and the controller goes into idle. The Start/Stop key indicator light will flash slowly. The controller will maintain temperature at the programmed set point.

6. The basket will raise automatically based on the value programmed in the Configuration Mode **ETYPE** / **btInE**.
7. To repeat cooking, repeat steps 1 through 6.

Auxiliary Idle Set Points

In some cases you may want to control at some non-cooking temperature such as during cleaning, preheating or to preserve the life of the oil. The controller is equipped with the capability of two auxiliary idle set points: Idle 1 and Idle 2.

To program either of the set points:

1. Press and hold down the Idle 1 Temp or Idle 2 Temp key.
2. While holding down the key, use the Up-arrow or Down-arrow key to adjust the set point temperature.
3. Release all of the keys.
The idle temperature has been set.
4. Program the other Idle temperature if desired by repeating 1 through 3 using the other Idle Temp key.

To run the fryer at an auxiliary idle set point:

- With the fryer in idle (not running a menu) press either the Idle1Temp or Idle2 Temp key.

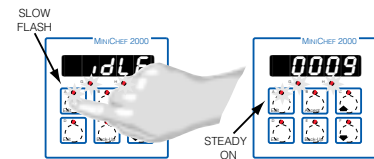

The indicator light over the Idle Temp key will flash slowly.

The fryer will run at the idle set point until you run a menu by pressing the Start/Stop key or you press the other Idle Temp key.

Manual Basket Lift

At any time you can raise or lower the basket manually by using the Down-arrow key (to lower) or the Up-arrow key (to raise). If you raise the basket manually while cooking, the timer will pause. Countdown time will resume when you manually lower the basket or when you press the active menu key.



WARNING: The Basket Up and Basket Down Keys cause or initiate motion. Appropriate reasonable care should be taken to prevent personal injury or machine damage as a result of operator initiated or unexpected machine motion.

Event Outputs

While running a menu:

Event output 1 is activated to lift the basket for the length of time programmed in Configuration Mode **ETYPE** / **btime**.

Event output 2 is activated to lower the basket for the length of time programmed in Configuration Mode **ETYPE** / **btime**.

Only one output can be on at a time.

Cancel a Menu

Canceling a menu stops controller completely. The controller does not maintain set point temperatures or run time. You cancel a menu to run another menu, stop menu operation for any reason, or are preparing to shut off the oven.

- Press the Start/Stop key for 2 seconds. Heat outputs will switch off. The heat output indicator light will switch off. IdLE or time of day will be on the display.

Restart a Menu

1. If the controller is preheating or running a menu, cancel the menu by pressing and holding the Start/Stop key for 2 seconds. If the controller is in **IdLE**, go to 2.
2. Press the Start/Stop key.

Based on its programming, the unit will run the menu in one of the ways described earlier.

Change Menus

1. With the controller in idle, select the menu you want to run by performing the procedure under “Select a Menu” earlier in this section.
2. Press the Start/Stop key.

Based on its programming, the unit will run the menu in one of the ways described earlier.

Temperature Alarms

The controller will alert you to temperature alarm conditions if they occur. If an alarm occurs, take action as determined by your supervisor. See the Appendix in the *Hardware & Software Setup Guide* for a Troubleshooting Chart and a summary of temperature alarms.

Errors

The controller will alert you to errors if they occur. Errors are critical problems that shut down the unit. If an error occurs, an error message will appear on the display. You should switch off the power and call for service.

See the Appendix in the *Hardware & Software Setup Guide* for a Troubleshooting Chart and a summary of errors.

Application 12

Manual Deepfat Fryer with Autolift Control

Single Heat Channel, One Menu

<i>Introduction to Application 12</i>	23
<i>Configuration Mode Quick Reference</i>	25
<i>Step 7 Design a Faceplate Overlay</i>	27
<i>Step 8 Operate the Controller</i>	28

Application 12 allows you to program a menu to control one temperature channel and cooking time for a manual deepfat fryer.

Overview of Key Steps

1. Install the MINICHEF 2000.
 2. Wire the controller.
 3. Configure the controller.
 4. Program the menu.
 5. Set the controller security.
 6. Set the Real-time Clock.
- For instructions on Steps 1, 2, 3, 4, 5 and 6, see the *Hardware & Software Setup Guide*.
7. Design, manufacture and apply faceplate overlay for end-users. (For a suggested design to suit this application, see this section. For overlay dimensions and guidelines, see the *Hardware & Software Setup Guide*.)
 8. Operate the controller. (See this application guide.)

Key Functions in Configuration Mode



Key Functions in Operation Mode

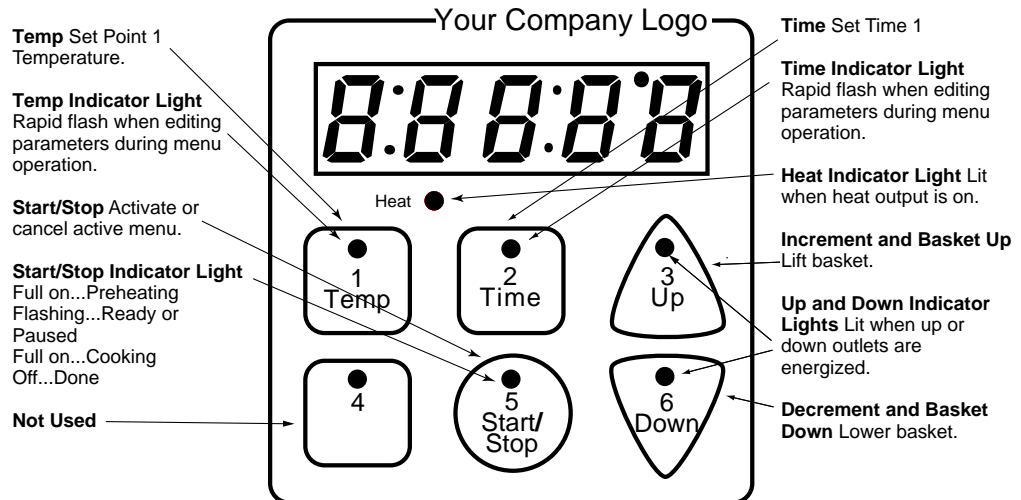

WARNING: The Basket Up and Basket Down Keys cause or initiate motion. Appropriate reasonable care should be taken to prevent personal injury or machine damage as a result of operator initiated or unexpected machine motion.

Summary of Input/Output Functions

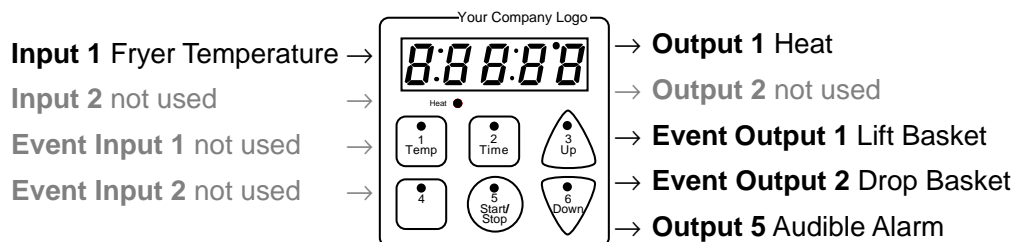

Note: For details, see wiring instructions in the *Hardware & Software Setup Guide*.

Configuration Mode Quick Reference

These are the functions, parameters and values included in the Configuration Mode for this application. You must select Application 12 to access them. For directions, see the *Hardware & Software Setup Guide*. The Appendix of that guide includes an explanation of all parameters and values.

Function	Parameter	Value	Your Settings
E E Y P E Equipment-Type	A P P L Application Number	1 - 28	12
	A _ L o c Application Number Security Lock	Yes, No	
	b t r n E Basket Travel Time	0 - 30	
	r n E L E Oil Melt Cycle	On, Off	
S E E T U P Setup	° C _ F Temperature Display Format	°C or °F	
	E _ i _ r _ n E Time Display Format	MMM:SS, HH:MM, H:MM:SS (H=Hours, M=Minutes, S=Seconds)	
	Chirp Key Chirp	On, Off	
	t c Thermocouple Type	J, K (shown as H), E	
	r t d RTD Curve	DIN, JIS	
	t c o n P WatCurve™ Temperature Compensation	On, Off	
	O F S E T 1 Temperature Offset, Channel 1	-99 to 99°F (-55° to 55°C)	
	t r L o Temperature Range Low	0°F (-18°C) for RTD inputs, 32°F (0°C) for tc inputs to t r H i	
	t r H i Temperature Range High	t r L o to 1200°F (649°C)	
	r E A D Y Preheat Ready Feature	Yes, No	
	r b A n d Ready Band	1 to 1200°F (649°C)	
	C L o c Real Time Clock Display	Yes, No	
	P L O S S Power Loss Menu Resume	Yes, No	
	A L Alarms for channel 1	None, Dev, Proc, Both	
	A L P 1 Absolute Process Alarm 1	100 to 1200°F (38 to 649°C)	
	A L d L 1 Low Deviation Alarm 1	-999 to 0°F (-555 to 0°C)	
A L d H 1 High Deviation Alarm 1	0 to 999°F (0 to 555°C)		
t H E r L Thermal	t Y P E Temperature Control Type	PID, On-Off	
	H Y S T 1 Hysteresis 1	1 to 99°F (1 to 55°C)	
	P i d U PID Units	SI, US	
	t u n E 1 Auto-tuning 1	on, OFF	
	P r o P 1 Proportional Band 1	1 to 999°F (1 to 555°C)	
	r S E T 1 Reset (integral) Gain 1	0.00 to 9.99 repeats/minute	
	i n t 1 Integral Gain 1	0.00 to 99.99 minutes/repeat	
	r R A T E 1 Rate (derivative) Gain 1	0.00 to 9.99 minutes	
	d E r 1 Derivative Gain 1	0.00 to 9.99 minutes	
	C Y c L 1 PID Cycle Time 1	1 to 60 seconds	
d i A G WatHelp Diagnostics	Used for equipment troubleshooting and testing. Not used when programming. See the <i>Hardware & Software Setup Guide</i> .		

Auto-tuning Note:

Before auto-tuning Application 12, **tENP 1** in the operations menu must first be set to a value that is typical of your application. (See the *Hardware & Software Setup Guide* for information on programming menus.) Then set **tHERL / tUnE 1** to **on**. After you accept **on**, by pressing “Enter,” the controller will display **tUnE** while auto-tuning is taking place.

The controller will cancel the auto-tuning process if it cannot be completed in 80 minutes. You can cancel the auto-tuning process at any time by pressing either key C or key D and accepting **OFF**, by pressing “Enter,” when it appears.

Step 7 Design a Faceplate Overlay

To complete the installation, you must apply a graphic membrane to the front panel of the controller. The following artwork will help you design and create a membrane for this application. For more dimensions and guidelines, see the *Hardware & Software Setup Guide*.

Suggested End-user Overlay:

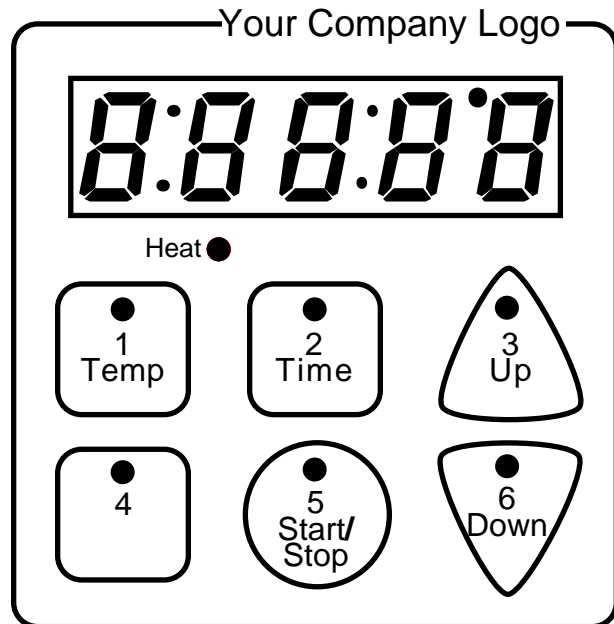

This Prototyping and Training Membrane Overlay will help you with the configuration and programming steps. To order it, see the Ordering Information at the back of this guide.

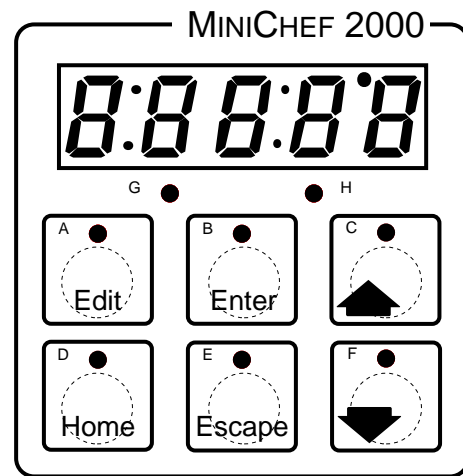

Step 8 Operate the Controller

Summary of Key Functions in Operation Mode

Key	Function
A	Temp
B	Time
C	Increment & Basket Up
D	Not Used
E	Start/Stop
F	Decrement & Basket Down

Startup

Apply power to the fryer and add cooking oil if necessary.

Set the Menu

Set the cooking temperature.

1. Press the Temp key **TEMP 1** and then the cooking temperature value will appear on the display.
2. Press the Up-arrow or Down-arrow key until the value you want appears on the display.
3. Press the Temp key again.

The cooking temperature has been set.

idle will appear on the display.

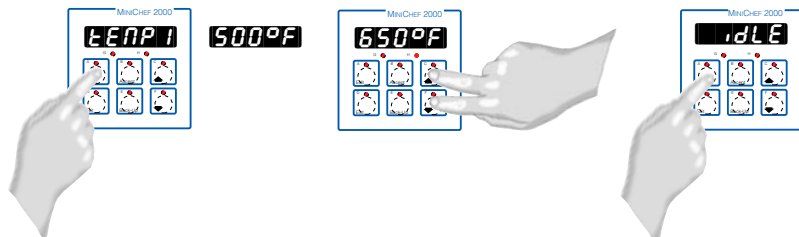

Set the cooking time.

1. Press the Time key **TIME 1** and then the cooking time value will appear on the display.
2. Press the Up-arrow or Down-arrow key until the value you want appears on the display.
3. Press the Time key again.

The cooking time has been set.

idle will appear on the display.

Five Second Timeout

When using the up or down keys to change a value, if you do not press any key for 5 seconds, the controller will automatically be set to the last value on the display and return to **.iDL E**.

Initial Preheat

At power-up, the unit will preheat to the temperature value set in the Configuration Mode **ETYP E** / **PREHE**. The display will show **PRE- HEAT** followed by oil temperature as the oil heats up.



When the unit reaches initial preheat temperature, **rEAdY** will flash once on the display and an audible tone will sound for 2 seconds. Then **.iDL E** will appear on the display. If the Real-time Clock option is installed and **SETUP / CLoc** is set to **YES**, the time of day will appear on the display.

If the preheat condition is met before power-up, the controller goes directly to idle, and does not display **rEAdY** or sound an audible tone.

Preheat

If in the Configuration Mode **SETUP / rEAdY** has been set to yes, the controller will detect temperatures and preheat to operating temperature (above relative set point minus the ready band) as required.

- Activate the menu by pressing the Start/Stop key.

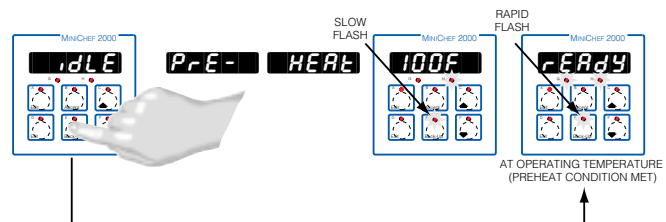

If the fryer is not at operating temperature, it will preheat. Meanwhile:

The word **PRE- HEAT** will appear on the display for a few moments. The Start/Stop key indicator light will flash slowly. The temperature of Channel 1 will be displayed until the operating temperature is reached.

The heat output indicator light - G, just below the display- will light up whenever the controller is calling for heat.

When the fryer is at operating temperature (above relative set point minus the ready band) **rEAdY** will appear on the display and the Start/Stop key indicator light will flash rapidly. You are now ready to cook with the active menu.

If the fryer is at operating temperature, the display goes directly to **rEAdY** without indicating preheat or temperature.

The Melt Cycle

To avoid burning congealed oil (shortening), a slow heating action may be necessary. If this is desired, be sure that in the Configuration Mode **TYPE / MELT** has been set to **on**. Then, when the oil temperature is below 212 °F the heat output will be limited to 10% of full power. This reduces the chance of burning congealed oil while it is heating.

Run a Menu (with preheat feature)

This procedure describes how to run an active menu when the preheat feature is inactive — in other words, when the **READY** parameter in the **SETUP** function of the Configuration Mode is set to **YES**.

1. Set the cooking time and temperature as shown earlier.
2. With **idle** or time of day on the display, press the Start/Stop key.

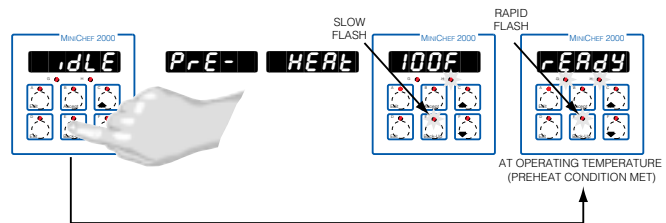

If the control's preheat condition has not been met, the fryer will preheat until **READY** appears on the display. If the fryer is at operating temperature **READY** will immediately appear on the display.

3. With **READY** on the display, place the food in the basket and press the Start/Stop key (indicated by the flashing red light). The Start/Stop indicator will light up, the basket will lower automatically. Time will count down on the display.

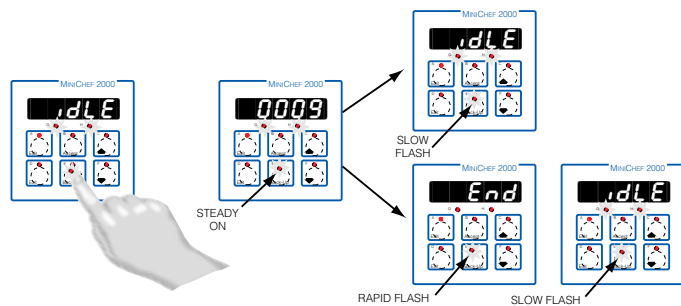

4. When the cooking cycle is finished the basket will rise automatically. One of the following will happen, depending on the way the controller was programmed at **TYPE / Sound**:

With Sound set to 0: The controller automatically switches to idle, where the controller maintains the temperatures at set point and does not run time. **idle** or time of day will appear on the display. The Start/Stop indicator light will flash slowly.

With Sound set to 1, 2, or 3, **End** will appear on the display and an audible tone will be emitted. The Start/Stop indicator light will flash rapidly. You can acknowledge and silence the tone by pressing the Start/Stop key or it will time out in 1 to 20 seconds and go into idle. The Start/Stop indicator light will flash slowly.

With Sound set to 4 or 5, **End** will appear on the display and the Start/Stop indicator light will flash rapidly. You must acknowledge the audible tone by pressing the Start/Stop key. Once acknowledged, the tone is silenced and the controller goes into idle. The Start/Stop indicator light will flash slowly.

- Remove the food from the basket. The controller will continue to regulate to the last set point. The Start/Stop indicator light will flash slowly.
- To repeat cooking, repeat steps 1 through 6.

Run a Menu (without preheat feature)

This procedure describes how to run the control when the preheat function is inactive — that is, when the **rERdy** parameter in the **SETUP** function of the Configuration Mode is set to **no** — and initial preheat power-up has been completed.

- Set the cook time and temperature as shown earlier.
- With **idle** or time of day on the display, press the Start/Stop key

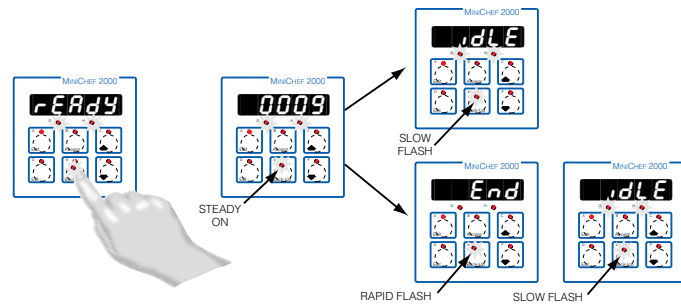

The Start/Stop will light up, the basket will lower automatically, and then time will count down on the display.

- When the cooking cycle is finished, the basket will rise automatically. One of the following will happen, depending on the way the controller was programmed at **ETYPE / Sound**:

With Sound set to 0: The controller automatically switches to idle, where the controller maintains the temperatures at set point and does not run time. **idle** or time of day will appear on the display.

With Sound set to 1, 2, or 3: **End** will appear on the display and an audible tone will be emitted. The Start/Stop indicator light will flash rapidly. You can acknowledge and silence the tone by pressing the Start/Stop key or it will time out in 1 to 20 seconds and go into idle.

With Sound set to 4 or 5: **End** will appear on the display and the Start/Stop key indicator light will flash rapidly. You must acknowledge the audible tone by pressing the Start/Stop key. Once acknowledged the tone is silenced and the controller goes into idle.

- Remove the food from the basket. The controller will continue to regulate at the last set point.

5. To repeat cooking, repeat steps 1 through 5.

Adjust a Menu While Cooking

You can adjust the temperature and time settings during the cooking and hold sequences by performing the actions shown under “Set the Menu” earlier in this section.

Changes can be made to temperature and time only during the portion of the cooking sequence in which they are active. For example: a change to the first cooking temperature **TEMP1** can be made only when the first cooking temperature is being run during the cooking sequence.

Temperature changes made while cooking are saved and become part of the permanent menu. Time changes are not saved and do not become part of the permanent menu.

Cancel a Menu

Canceling the menu stops controller operation completely. The controller does not maintain set point temperatures or run time. Users may cancel the control operation in order to run another one, to stop control operation for any reason, or when preparing to shut off the fryer.

- Press the Start/Stop key for 2 seconds.

Heat outputs will switch off. Heat output indicator lights will switch off. The display presents **IDLE** or the time of day will appear on the display.

Change or Restart Menus

1. Set time and temperature as shown earlier.
2. Press the Start/Stop key.

Manual Basket Lift

You can raise or lower the basket manually at any time by pressing the Down-arrow key (to lower) or the Up-arrow key (to raise). If you raise the basket while cooking, the timer will pause. Countdown time will resume when you lower the basket or when you press the active menu key.



WARNING: The Basket Up and Basket Down Keys cause or initiate motion. Appropriate reasonable care should be taken to prevent personal injury or machine damage as a result of operator initiated or unexpected machine motion.

Event Outputs

While running a menu:

Event output 1 is activated to lift the basket for the length of time programmed in Configuration Mode **ETYPE** / **bt inE**.

Event output 2 is activated to lower the basket for the length of time programmed in Configuration Mode **ETYPE** / **bt inE**.

Only one output can be on at a time.

Temperature Alarms

The controller will alert you to temperature alarm conditions if they occur. If an alarm occurs, take action as determined by your supervisor. See the Appendix in the *Hardware*

& Software Setup Guide for a Troubleshooting Chart and a summary of temperature alarms.

Errors

The controller will alert you to errors if they occur. Errors are critical problems that shut down the unit. If an error occurs, an error message will appear on the display. You should switch off the power and call for service.

See the Appendix in the *Hardware & Software Setup Guide* for a Troubleshooting Chart and a summary of errors.

Notes

Application 13

Pressurized Automatic Deepfat Fryer

Single Heat Channel, Six Menus

<i>Introduction to Application 13</i>	35
<i>Configuration Mode Quick Reference</i>	37
<i>Program Mode Quick Reference</i>	38
<i>Step 7 Design a Faceplate Overlay</i>	39
<i>Step 8 Operate the Controller</i>	40

Application 13 allows you to program as many as six menus, each of which will control one heat channel, one cooking time and a pressure release time.

Overview of Key Steps

1. Install the MINICHEF 2000.
2. Wire the controller.
3. Configure the controller.
4. Program the menus.
5. Set the controller security.
6. Set the Real-time Clock.
For instructions on Steps 1, 2, 3, 4, 5 and 6, see the *Hardware & Software Setup Guide*.
7. Design, manufacture and apply faceplate overlay for end-users. (For a suggested design to suit this application, see this section. For overlay dimensions and guidelines, see the *Hardware & Software Setup Guide*.)
8. Operate the controller. (See this application guide.)

Key Functions in Configuration Mode



Key Functions in Operation Mode

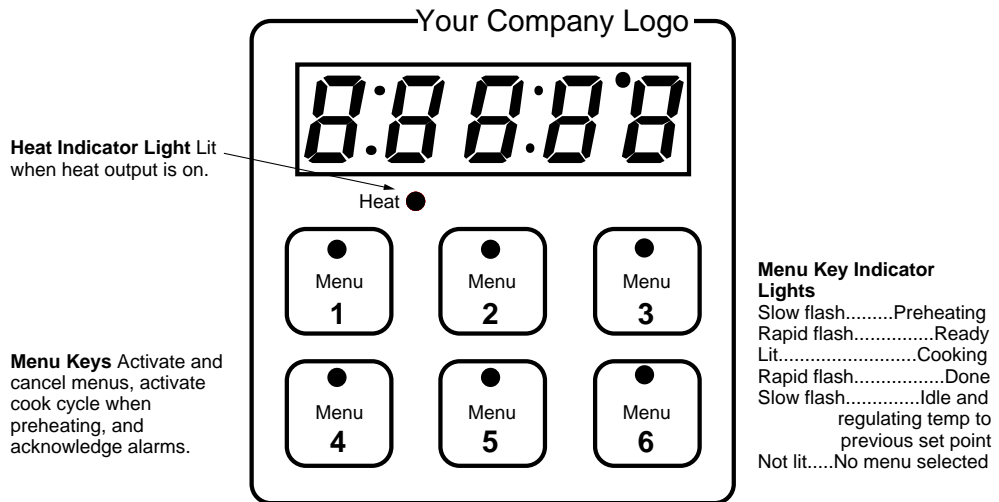

Summary of Input/Output Functions

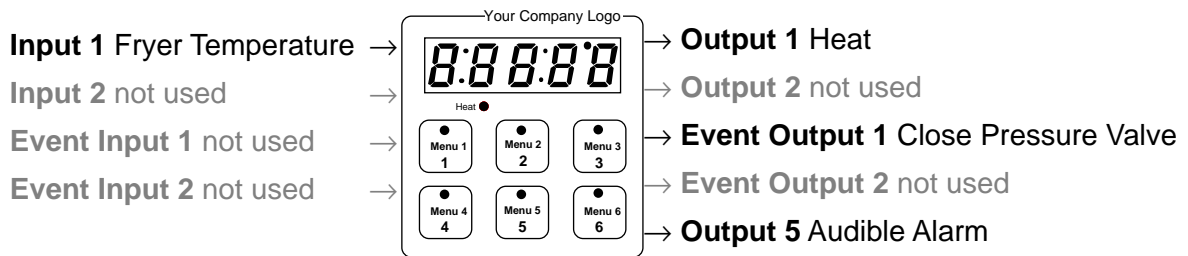

Note: For details, see wiring instructions in the *Hardware & Software Setup Guide*.

Configuration Mode Quick Reference

These are the functions, parameters and values included in the Configuration Mode for this application. You must select Application 13 to access them. For directions, see the *Hardware & Software Setup Guide*. The Appendix of that guide includes an explanation of all parameters and values.

Function	Parameter	Value	Your settings		
EQUIP Equipment-Type	APPL Application Number	1 - 28	13		
	A_Loc Application Number Security Lock	Yes, No			
	Sound Audible Alarm Sound	0 - 5			
	PrTime Pressure Release Time	1 - 120 seconds			
	PrEHT Initial Preheat Temperature	Range low to range high			
	PrMELT Oil Melt Cycle	On, Off			
SETUP Setup	TEMP Temperature Display Format	°C or °F			
	TIME Time Display Format	MM:SS, HH:MM, H:MM:SS (H=Hours, M=Minutes, S=Seconds)			
	Chirp Key Chirp	On, Off			
	Loc Menu Security Lock	Yes, No			
	TC Thermocouple Type	J, K (shown as H), E			
	RTD RTD Curve	DIN, JIS			
	TCOMP WatCurve™ Temperature Compensation	On, Off			
	Offset1 Temperature Offset, Channel 1	-99 to 99°F (-55 to 55°C)			
	TrLo Temperature Range Low	0°F (-18°C) for RTD inputs 32°F (0°C) for tc inputs to TrHi			
	TrHi Temperature Range High	TrLo to 1200°F (649°C)			
	READY Preheat Ready Feature	Yes, No			
	ReadyBnd Ready Band	1 to 1200°F (649°C)			
	CLoc Real Time Clock Display	Yes, No			
	PLoss Power Loss Menu Resume	Yes, No			
	AL1 Alarms for channel 1	None, Dev, Proc, Both			
	ALP1 Absolute Process Alarm 1	100 to 1200°F (38 to 649°C)			
	ALDL1 Low Deviation Alarm 1	-999 to 0°F (-555 to 0°C)			
	ALDH1 High Deviation Alarm 1	0 to 999°F (0 to 555°C)			
	THERM Thermal	TYPE Temperature Control Type		PID, On-Off	
		HYS1 Hysteresis 1		1 to 99°F (1 to 55°C)	
PIDU PID Units		SI, US			
TUNE1 Auto-tuning 1		on, OFF			
PROP1 Proportional Band 1		1 to 999°F (1 to 555°C)			
RSET1 Reset (integral) Gain 1		0.00 to 9.99 repeats/minute			
INT1 Integral Gain 1		0.00 to 99.99 minutes/repeat			
RATE1 Rate (derivative) Gain 1		0.00 to 9.99 minutes			
DER1 Derivative Gain 1		0.00 to 9.99 minutes			
CYCL1 PID Cycle Time 1		1 to 60 seconds			
diag WatHelp Diagnostics	Used for equipment troubleshooting and testing. Not used when programming. See the <i>Hardware & Software Setup Guide</i> .				

Program Mode Quick Reference

These are the functions, parameters and values included in the Program Mode for this application. You must select Application 13 to access them. For menu programming directions, see the *Hardware & Software Setup Guide*. The Appendix of that guide includes a detailed explanation of all parameters and values.

Function	Parameter	Value	Your Settings
PF1 Menu Numbers 1-6	SETE1 Setpoint 1 Temperature of channel 1.	Temp range low to temp range high	
	TUNE1 Time 1 Menu run time.	Format varies based on configuration. Setting at 0 invalidates selected menu.	

Auto-tuning Note:

Before auto-tuning Application 13, Set Point 1 of Menu 1 must first be set to a value that is typical of your application. (See *Hardware & Software Setup Guide* for information on programming menus.). Then set **THERL** / **TUNE1** to **on**. After you accept **on**, by pressing “Enter,” the controller will display **TUNE** while auto-tuning is taking place.

The controller will cancel the auto-tuning process if it cannot be completed in 80 minutes. You can cancel the auto-tuning process at any time by pressing either key C or key D and accepting **OFF**, by pressing “Enter,” when it appears.

Step 7 Design a Faceplate Overlay

To complete the installation, you must apply a graphic membrane to the front panel of the controller. The following artwork will help you design and create a membrane for this application. For more dimensions and guidelines, see the *Hardware & Software Setup Guide*.

Suggested End-user Overlay:

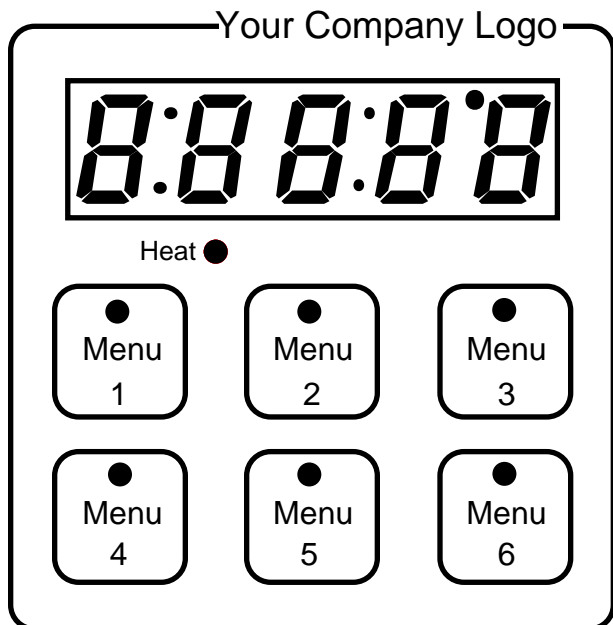

This Prototyping and Training Membrane Overlay will help you with the configuration and programming steps. To order it, see the Ordering Information at the back of this guide.



Step 8 Operate the Controller

Summary of Key Functions in Operation Mode

Key	Function
A	Menu 1
B	Menu 2
C	Menu 3
D	Menu 4
E	Menu 5
F	Menu 6

Startup

1. Apply power to the fryer and add cooking oil if necessary.

Initial Preheat

At power-up, the unit will preheat to the temperature value set in the Configuration Mode **SETUP** / **PREHEAT**. The display will show **PRE- HEAT** followed by oil temperature as the oil heats.



When the unit reaches initial preheat temperature, **READY** will flash once on the display and an audible tone will sound for 2 seconds. Then **IDLE** will appear on the display. (If Real Time Clock option is installed and **SETUP** / **CLOCK** is set to **YES**, the time of day will appear on the display).

Preheat

If in the Configuration Mode **SETUP** / **READY** has been set to yes, the controller will detect temperatures and preheat to operating temperature (above relative set point minus the ready band) as required.

- Activate the menu by pressing the Start/Stop key.

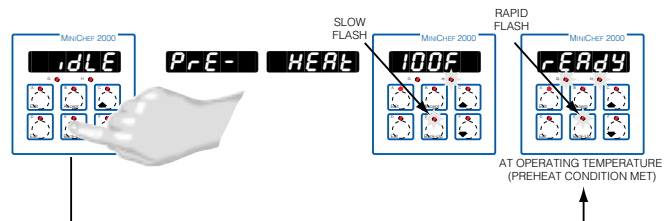

If the fryer is not at operating temperature, it will preheat. Meanwhile:

The word **PRE- HEAT** will appear on the display for a few moments. The Start/Stop key indicator light will flash slowly. The temperature of Channel 1 will be displayed until the operating temperature is reached.

The heat output indicator light - G, just below the display- will light up whenever the controller is calling for heat.

When the fryer is at operating temperature (above relative set point minus the ready band) **rEAdy** will appear on the display and the Start/Stop key indicator light will flash rapidly. You are now ready to cook with the active menu.

If the fryer is at operating temperature, the display goes directly to **rEAdy** without indicating preheat or temperature.

The Melt Cycle

To avoid burning congealed oil (shortening), a slow heating action may be necessary. If this is desired be sure that in the Configuration Mode **ELtYPE** / **rMELt** has been set to **on**. Then, when the oil temperature is below 212°F the heat output will be limited to 10% of full power. This reduces the chance of burning congealed oil while it is melting.

Run a Menu (with preheat feature)

This procedure describes how to run an active menu when the preheat feature is inactive — in other words, when the **rEAdy** parameter in the **SEtUP** function of the Configuration Mode is set to **YES**

1. With **idle** on the display, press the key for the menu you want to run.

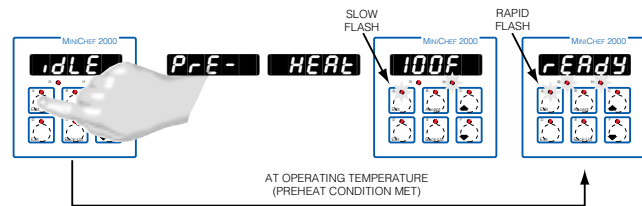

If the selected menu's preheat condition has not been met, the fryer will preheat until **rEAdy** appears on the display. If the fryer is at operating temperature, **rEAdy** will immediately appear on the display.

2. With **rEAdy** on the display, place the food in the pressure fryer and secure the lid on the pressure vessel.

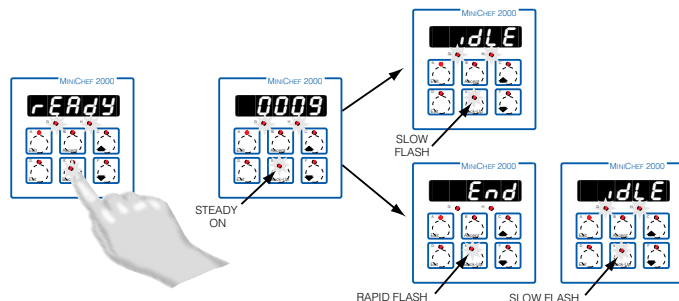

3. Press the active menu key (indicated by the rapidly flashing indicator light).
The menu key indicator light will light up. Time will count down on the display. When the menu cycle nears completion, pressure will be released from the fryer based on the time programmed in Configuration Mode, **ELtYPE** / **PrE tInE**
4. When the cooking cycle is finished, one of the following will happen, depending on

the way the controller was programmed at **ETYPE / Sound**:

With Sound set to 0: The controller automatically switches to **idLE**, where the controller maintains the temperatures at set point and does not run time. **idLE** or current time of day will appear on the display. The menu key indicator light flashes slowly.

With Sound set to 1, 2, or 3, **End** will appear on the display and an audible tone will be emitted. The menu key indicator light will flash rapidly. You can acknowledge and silence the tone by pressing the active menu key or it will time out in 1 to 20 seconds and go into idle. The menu key indicator light will flash slowly.

With Sound set to 4 or 5, **End** will appear on the display and the menu key indicator light will flash rapidly. You must acknowledge the audible tone by pressing the active menu key. Once acknowledged, the tone is silenced and the controller goes into idle. The menu key indicator light will flash slowly.

5. After pressure release time is complete, open lid and carefully and safely remove the food. The controller will continue to regulate at the last setpoint. The menu key indicator light will flash slowly.
6. To repeat cooking, repeat steps 1 through 5.

Run A Menu (without preheat feature)

This procedure describes how to run a menu when the preheat function is inactive — in other words, when the **rEAdy** parameter in the **SEtUP** function of the Configuration Mode is set to **no** — and initial preheat power-up has been completed.

1. With **idLE** on the display, place the food in the pressure fryer and secure the lid on the pressure vessel.

The menu key indicator light will light up. Time will count down on the display.

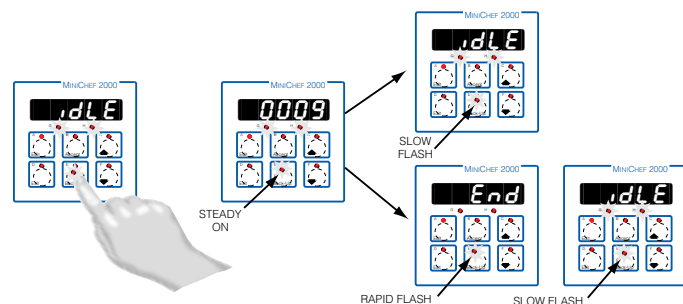

2. Press the key for the menu you want to run.

The indicator above the selected menu key will light up. Time will countdown on the display.

When the menu cycle nears completion, pressure will be released from the fryer based on the time programmed in Configuration Mode **ETYPE / PtInE**.

3. When the cooking cycle is finished, one of the following will happen, depending on the way the controller was programmed at **ETYPE / Sound**:

With Sound set to 0: The controller automatically switches to **idLE**, where the controller maintains the temperatures at set point and does not run time. **idLE** or current time of day will appear on the display. The menu key indicator light

flashes slowly.

With Sound set to 1, 2, or 3: **End** will appear on the display and an audible tone will be emitted. The menu key indicator light will flash rapidly. You can acknowledge and silence the tone by pressing the active menu key or it will time out in 1 to 20 seconds and go into **idLE**. The menu key indicator light will flash slowly.

With Sound set to 4 or 5: **End** will appear on the display and the menu key indicator light will flash rapidly. You must acknowledge the audible tone by pressing the active menu key. Once acknowledged, the tone is silenced and the controller goes into **idLE**. The menu key indicator light will flash slowly.

4. Remove the food carefully and safely.

The controller will continue to regulate at the last set point. The menu key indicator light will flash slowly.

5. To repeat cooking, repeat steps 1 through 3.

Event outputs

Event output 1 assists in controlling pressure.

Event output 1 will switch on when a menu starts and switch off when the time remaining is equal to the value programmed in Configuration Mode under **ETYPE** / **PrnE**.

If a menu is cancelled, Event output 1 switches off immediately.

Cancel a menu

Canceling a menu stops controller operation completely. The controller does not maintain set point temperatures or run time. Users may cancel a menu in order to run another one, to stop menu operation for any reason, or when preparing to shut off the fryer.

Press the active menu key for 2 seconds.

Heat outputs will switch off. Heat output indicator lights will switch off. The display presents **idLE** or the time of day will appear on the display.

Change menus or restart

With the controller in idle, close pressure vessel or ensure pressure vessel is closed. Press the key for the menu you want to run.

Temperature Alarms

The controller will alert you to temperature alarm conditions if they occur. If an alarm occurs, take action as determined by your supervisor. See the Appendix in the *Hardware & Software Setup Guide* for a Troubleshooting Chart and a summary of temperature alarms.

Errors

The controller will alert you to errors if they occur. Errors are critical problems that shut down the unit. If an error occurs, an error message will appear on the display. You should switch off the power and call for service.

See the Appendix in the *Hardware & Software Setup Guide* for a Troubleshooting Chart and a summary of errors.

Notes

Application 14

Pressurized Automatic Deepfat Fryer

One Heat Channel, 40 Menus

<i>Introduction to Application 14</i>	<i>45</i>
<i>Configuration Mode Quick Reference</i>	<i>47</i>
<i>Program Mode Quick Reference</i>	<i>48</i>
<i>Step 7 Design a Faceplate Overlay</i>	<i>49</i>
<i>Step 8 Operate the Controller</i>	<i>50</i>

Application 14 allows you to program as many as forty menus to control one temperature channel, a fan and cooking time for a pressurized automatic deepfat fryer.

Overview of Key Steps

1. Install the MINICHEF 2000.
2. Wire the controller.
3. Configure the controller.
4. Program the menus.
5. Set the controller security.
6. Set the Real-time Clock.

For instructions on Steps 1, 2, 3, 4, 5 and 6, see the *Hardware & Software Setup Guide*.

7. Design, manufacture and apply faceplate overlay for end-users. (For a suggested design to suit this application, see this section. For overlay dimensions and guidelines, see the *Hardware & Software Setup Guide*.)
8. Operate the controller. (See this application guide.)

Key Functions in Configuration Mode



Key Functions in Operation Mode

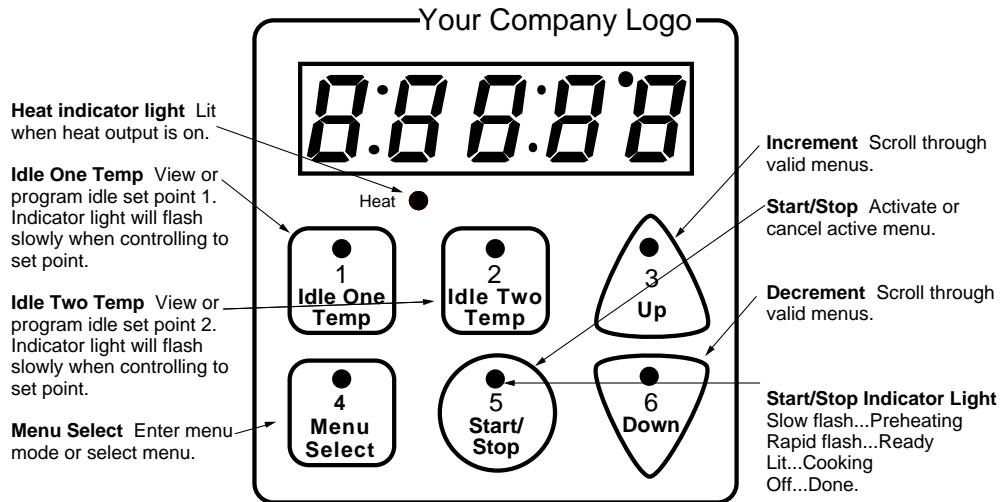

Summary of Input/Output Functions

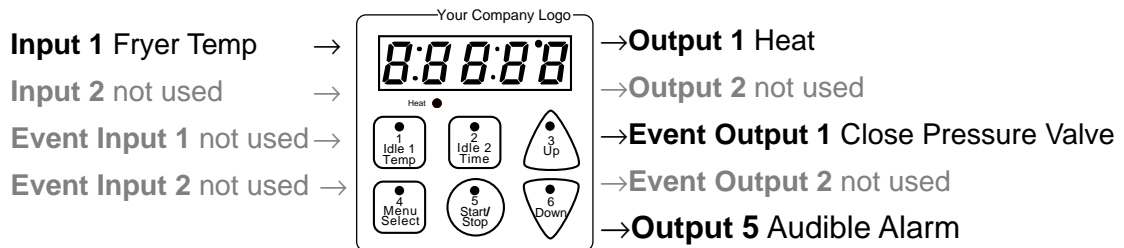

Note: For details, see wiring instructions in the *Hardware & Software Setup Guide*.

Configuration Mode Quick Reference

These are the functions, parameters and values included in the Configuration Mode for this application. You must select Application 14 to access them. For directions, see the *Hardware & Software Setup Guide*. The Appendix of that guide includes an explanation of all parameters and values.

Function	Parameter	Value	Your Settings
E E Y P E Equipment-Type	A P P L Application Number	1 - 28	14
	A _ L o c Application Number Security Lock	Yes, No	
	S o u n d Audible Alarm Sound	0 - 5	
	P r e l e a s e Pressure Release Time	1 - 120 seconds	
	P r e h e a t Preheat Temperature	range low to range high	
	I d l e 1 Channel 1 Idle Temperature	range low to range high	
	I d l e 2 Channel 2 Idle Temperature	range low to range high	
	O i l M e l t Oil Melt Cycle	On, Off	
S E T U P Setup	C _ F Temperature Display Format	°C or °F	
	T i m e Time Display Format	MMM:SS, HH:MM, H:MM:SS (H=Hours, M=Minutes, S=Seconds)	
	C h i r p Key Chirp	On, Off	
	L o c Menu Security Lock	Yes, No	
	T c Thermocouple Type	J, K (shown as H), E	
	r t d RTD Curve	DIN, JIS	
	t c o n p WatCurve™ Temperature Compensation	On, Off	
	O F S E T 1 Temperature Offset, Channel 1	-99 to 99°F (-55 to 55°C)	
	t r L o Temperature Range Low	0°F (-18°C) for RTD inputs, 32°F (0°C) for tc inputs to t r H i	
	t r H i Temperature Range High	t r L o to 1200°F (649°C)	
	r e a d y Preheat Ready Feature	Yes, No	
	r b a n d Ready Band	1 to 1200°F (649°C)	
	C l o c k Real Time Clock Display	Yes, No	
	P L O S S Power Loss Menu Resume	Yes, No	
	A L 1 Alarms for channel 1	None, Dev, Proc, Both	
	A L P 1 Absolute Process Alarm 1	100 to 1200°F (38 to 649°C)	
	A L D L 1 Low Deviation Alarm 1	-999 to 0°F (-555 to 0°C)	
	A L D H 1 High Deviation Alarm 1	0 to 999°F (0 to 555°C)	
	T H E R M Thermal	T y p e Temperature Control Type	PID, On-Off
		H y s t e r Hysteresis 1	1 to 99°F (1 to 55°C)
P i d U PID Units		SI, US	
t u n e 1 Auto-tuning 1		on, OFF	
P r o p 1 Proportional Band 1		1 to 999°F (1 to 555°C)	
r s e t 1 Reset (integral) Gain 1		0.00 to 9.99 repeats/minute	
i n t 1 Integral Gain 1		0.00 to 99.99 minutes/repeat	
r a t e 1 Rate (derivative) Gain 1		0.00 to 9.99 minutes	
d e r 1 Derivative Gain 1		0.00 to 9.99 minutes	
C y c l e 1 PID Cycle Time 1		1 to 60 seconds	
d i a g WatHelp Diagnostics		Used for equipment troubleshooting and testing. Not used when programming. See the <i>Hardware & Software Setup Guide</i> .	

Program Mode Quick Reference

These are the functions, parameters and values included in the Program Mode for this application. You must select Application 14 to access them. For menu programming directions, see the *Hardware & Software Setup Guide*. The Appendix of that guide includes a detailed explanation of all parameters and values.

Function	Parameter	Value	Your Settings
P7 Menu Numbers 1 - 40	SEPt 1 Set point 1 Temperature of set point 1.	Temp range low to temp range high.	
	TIME 1 Time 1 Run time of set point 1.	Format varies based on configuration.	

Auto-tuning Note:

Before auto-tuning Application 14, the Set Point 1 of Menu 1 must first be set to a value that is typical of your application. (See *Hardware & Software Setup Guide* for information on programming menus.) Then set **tHERL / tUnE 1** to **on**. After you accept **on**, by pressing “Enter,” the controller will display **tUnE** while auto-tuning is taking place.

The controller will cancel the auto-tuning process if it cannot be completed in 80 minutes. You can cancel the auto-tuning process at any time by pressing either key C or key D and accepting **OFF**, by pressing “Enter,” when it appears.

Step 7 Design a Faceplate Overlay

To complete the installation, you must apply a graphic membrane to the front panel of the controller. The following artwork will help you design and create a membrane for this application. For more dimensions and guidelines, see the *Hardware & Software Setup Guide*.

Suggested End-user Overlay:

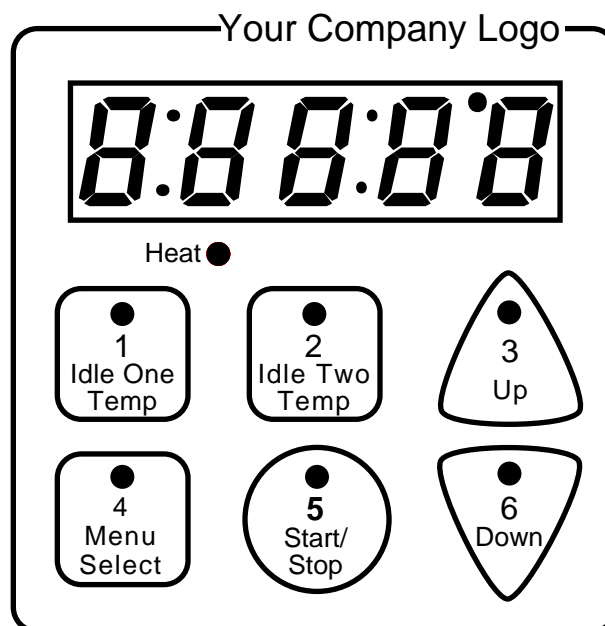

This Prototyping and Training Membrane Overlay will help you with the configuration and programming steps. To order it, see the Ordering Information at the back of this guide.

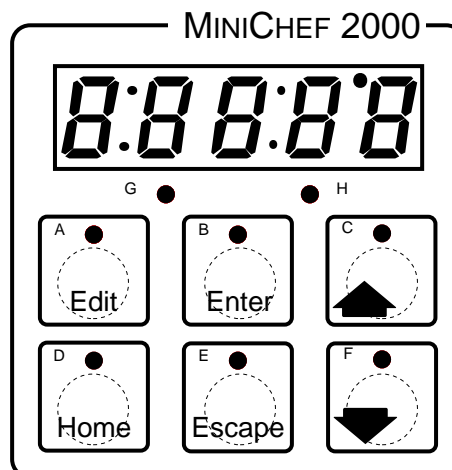

Step 8 Operate the Controller

Summary of Key Functions in Operation Mode

Key	Function
A	Idle one temperature
B	Idle two temperature
C	Increment
D	Menu select
E	Start/Stop
F	Decrement

Start-up

Apply power to the fryer and add cooking oil if necessary.

Select a Menu

1. Press the Menu Select key.

The controller will display the currently selected menu. If no menus have been programmed the word **none** will appear on the display.

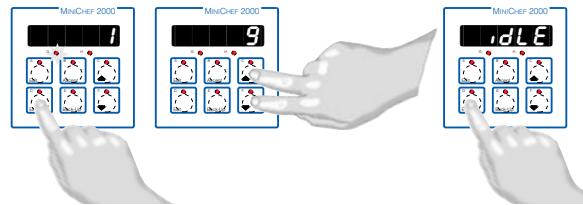

2. Press the Up-arrow or Down-arrow key until the menu you want appears on the display.

The controller will only display valid menus (those for which Time1 for the menu is set to greater than 0).

3. Press the Menu Select key again.

The menu you have chosen becomes the current menu for controller operation.

Initial Preheat

At power-up, the unit will preheat to the temperature value set in the Configuration Mode **TEMP** / **PREHE**. The display will show **PRE- HEAT** followed by oil temperature as the oil heats up.



When the unit reaches initial preheat temperature, **rEAdy** will flash once on the display and an audible tone will sound for 2 seconds. Then **idLE** will appear on the display. (If the Real-time Clock option is installed and **SEtUP / CLocK** is set to **YES**, the time of day will appear on the display.)

If the preheat condition is met before power-up, the controller goes directly to idle, and does not display **rEAdy** or sound an audible tone.

Preheat

If in the Configuration Mode **SEtUP / rEAdy** has been set to yes, the controller will detect temperatures and preheat to operating temperature (above relative set point minus the ready band) as required.

- Activate the current menu by pressing the Start/Stop key.

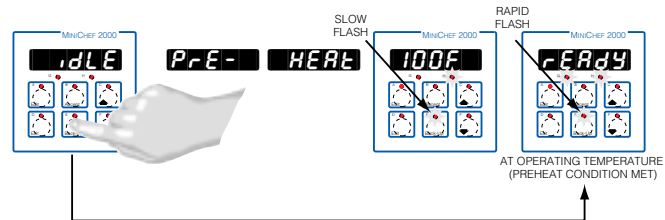

If the fryer is not at operating temperature, it will preheat. Meanwhile:

The word **PrE- HEAt** will appear on the display for a few moments. The Start/Stop key indicator light will flash slowly. The temperature of Channel 1 will be displayed until the operating temperature is reached.

The heat output indicator light - G, just below the display- will light up whenever the controller is calling for heat.

When the fryer is at operating temperature (above relative set point minus the ready band) **rEAdy** will appear on the display and the Start/Stop key indicator light will flash rapidly. You are now ready to cook with the active menu.

If the fryer is at operating temperature, the display goes directly to **rEAdy** without indicating preheat or temperature.

The Melt Cycle

To avoid burning, congealed oil requires a slow heating action. If in the Configuration Mode, **EtYpE / MElT** has been set to on, when the oil temperature is below 212°F the heat output will be limited to 10% of full power.

Run a Menu (with preheat feature)

This procedure describes how to run an active menu when the preheat feature is active — in other words, when the **rEAdy** parameter in the **SEtUP** function of the Configuration Mode is set to **YES**.

1. Select the menu you want to run as shown earlier in “Select a Menu”.
2. With **idLE** or time of day on the display, press the Start/Stop key.

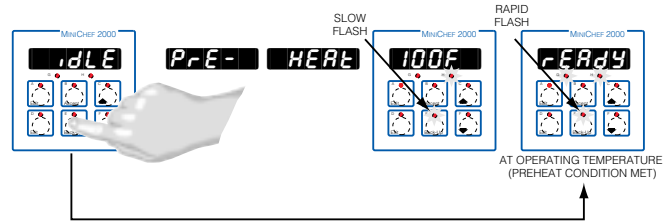

If the preheat condition has not been met, the fryer will preheat until **rEAdy** appears on the display. If the fryer is at operating temperature **rEAdy** will immediately appear on the display.

- With **rEAdy** on the display, place the food in the pressure fryer and secure the lid on the pressure vessel.

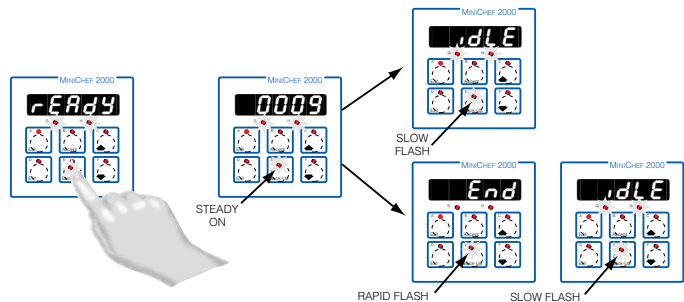

- Press the Start/Stop key. The Start/Stop key indicator light will light up. Time will count down on the display.

When the menu cycle nears completion, pressure will be released from the fryer based on the time programmed in Configuration Mode, **EtYpE** / **Pt inE**

- When the cooking cycle is finished, one of the following will happen, depending on the way the controller was programmed at **EtYpE** / **Sound**:

With Sound set to 0: The controller automatically switches to **idLE**, where the controller maintains the temperatures at set point and does not run time. **idLE** or current time of day will appear on the display. The Start/Stop Key(E) indicator light flashes slowly.

With Sound set to 1, 2, or 3, **End** will appear on the display and an audible tone will be emitted. The menu key indicator light will flash rapidly. You can acknowledge and silence the tone by pressing the active menu key or it will time out in 1 to 20 seconds and go into idle. The start/stop key indicator light will flash slowly.

With Sound set to 4 or 5, **End** will appear on the display and the menu key indicator light will flash rapidly. You must acknowledge the audible tone by pressing the active menu key. Once acknowledged, the tone is silenced and the controller goes into idle. The Start/Stop key indicator light will flash slowly.

- Carefully and safely remove the food. The controller will continue to regulate at the last setpoint. The Start/Stop key indicator light will flash slowly.
- To repeat cooking, repeat steps 1 through 6.

Run A Menu (without preheat feature)

This procedure describes how to run a menu when the preheat function is inactive — in other words, when the **rEAdy** parameter in the **SEtUP** function of the Configuration Mode is set to **no** — and initial preheat power-up has been completed.

1. Select the menu you want to run as shown earlier in “Select a Menu.”
2. With **idLE** or time of day on the display, place food in the pressure fryer and secure the lid on the pressure vessel.

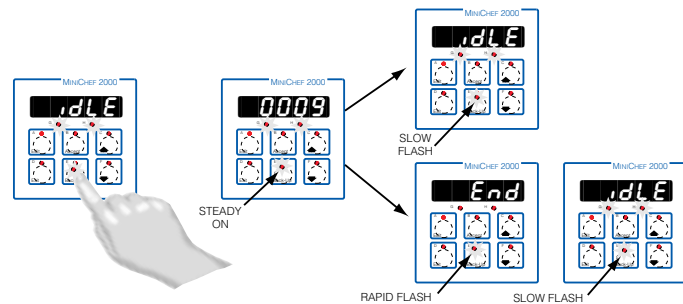

3. Press the Start/Stop key. The Start/Stop key will light up and time will count down on the display.

When the menu cycle nears completion, pressure will be released from the fryer based on the time programmed in Configuration Mode **EtYPE** / **PtInE**.

4. When the cooking cycle is finished, one of the following will happen, depending on the way the controller was programmed at **EtYPE** / **Sound**.

With **Sound** set to 0: The controller automatically switches to **idLE**, where the controller maintains the temperatures at set point and does not run time. **idLE** or current time of day will appear on the display. The Start/Stop key indicator light flashes slowly.

With **Sound** set to 1, 2, or 3: **End** will appear on the display and an audible tone will be emitted. The menu key indicator light will flash rapidly. You can acknowledge and silence the tone by pressing the active Start/Stop key or it will time out in 1 to 20 seconds and go into **idLE**. The Start/Stop key indicator light will flash slowly.

With **Sound** set to 4 or 5: **End** will appear on the display and the menu key indicator light will flash rapidly. You must acknowledge the audible tone by pressing the active menu key. Once acknowledged, the tone is silenced and the controller goes into **idLE**. The Start/Stop key indicator light will flash slowly.

5. Remove the food carefully and safely.
The controller will continue to regulate at the last set point. The Start/Stop key indicator light will flash slowly.
6. To repeat cooking, repeat steps 1 through 5.

Event outputs

Event output 1 assists in controlling pressure.

Event output 1 will switch on when a menu starts and switch off when the time remaining is equal to the value programmed in the Configuration Mode under **ETYPE** / **PTIME**.

If a menu is cancelled, Event output 1 switches off immediately.

Cancel a menu

Canceling a menu stops the controller operation completely. The controller does not maintain set point temperatures or run time. Users may cancel a menu in order to run another one, to stop menu operation for any reason, or when preparing to shut off the fryer.

- Press the active Start/Stop key for 2 seconds.

Heat outputs will switch off. Heat output indicator lights will switch off. Event 1 also switches off, releasing pressure. The display presents **IDLE** or the time of day will appear on the display.

Change menus or restart

With the controller in idle, select a menu as shown earlier, and press the Start/Stop key.

Temperature Alarms

The controller will alert you to temperature alarm conditions if they occur. If an alarm occurs, take action as determined by your supervisor. See the Appendix in the *Hardware & Software Setup Guide* for a Troubleshooting Chart and a summary of temperature alarms.

Errors

The controller will alert you to errors if they occur. Errors are critical problems that shut down the unit. If an error occurs, an error message will appear on the display. You should switch off the power and call for service.

See the Appendix in the *Hardware & Software Setup Guide* for a Troubleshooting Chart and a summary of errors.

Application 15

Pressurized Manual Deepfat Fryer

One Heat Channel

<i>Introduction to Application 15</i>	<i>55</i>
<i>Configuration Mode Quick Reference</i>	<i>57</i>
<i>Step 7 Design a Faceplate Overlay</i>	<i>59</i>
<i>Step 8 Operate the Controller</i>	<i>60</i>

Application 15 allows you to program one temperature channel and cooking time for a pressurized manual deepfat fryer.

Overview of Key Steps

1. Install the MINICHEF 2000.
2. Wire the controller.
3. Configure the controller.
4. Program the menu.
5. Set the controller security.
6. Set the Real-time Clock.
For instructions on Steps 1, 2, 3, 4, 5 and 6, see the *Hardware & Software Setup Guide*.
7. Design, manufacture and apply faceplate overlay for end-users. (For a suggested design to suit this application, see this section. For overlay dimensions and guidelines, see the *Hardware & Software Setup Guide*.)
8. Operate the controller. (See this application guide.)

Key Functions in Configuration Mode



Key functions in Operation Mode

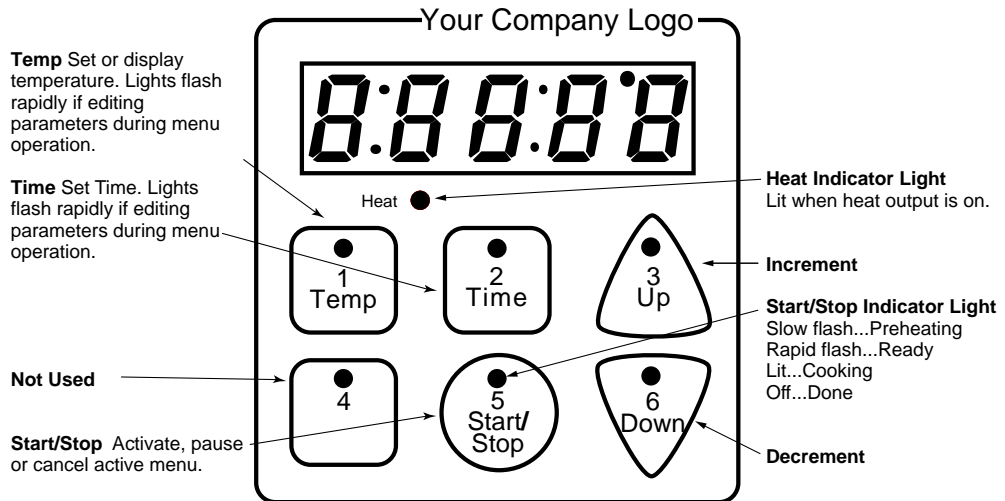

Summary of Input/Output Functions

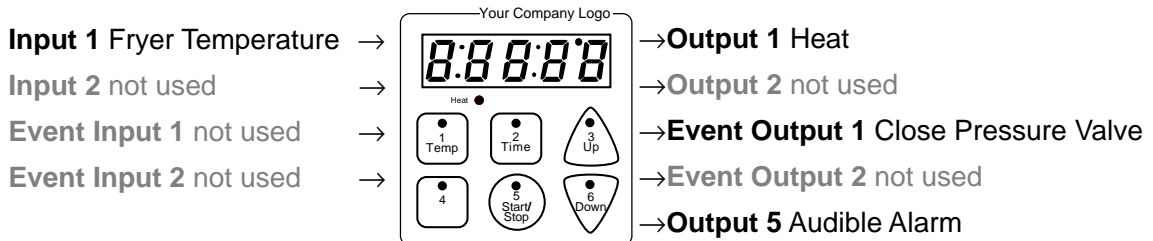

Note: For details, see wiring instructions in the *Hardware & Software Setup Guide*.

Configuration Mode Quick Reference

These are the functions, parameters and values included in the Configuration Mode for this application. You must select Application 15 to access them. For directions, see the *Hardware & Software Setup Guide*. The Appendix of that guide includes an explanation of all parameters and values.

Function	Parameter	Value	Your Settings
E E Y P E Equipment-Type	A P P L Application Number	1 - 28	15
	A L L o c Application Number Security Lock	Yes, No	
	P R e l e Pressure Release Time	1 - 120 seconds	
	O i l M e l t C y c l e Oil Melt Cycle	On, Off	
S E T U P Setup	C F Temperature Display Format	C or °F	
	T i m e Time Display Format	MM:SS, HH:MM, H:MM:SS (H=Hours, M=Minutes, S=Seconds)	
	C h i r p Key Chirp	On, Off	
	t c Thermocouple Type	J, K (shown as H), E	
	r t d RTD Curve	DIN, JIS	
	W a t C u r v e WatCurve™ Temperature Compensation	On, Off	
	O F S E T 1 Temperature Offset, Channel 1	-99 to 99°F (-55 to 55°C)	
	T e m p e r a t u r e R a n g e L o w	0°F (-18°C) for RTD inputs, 32°F (0°C) for tc inputs to T e m p e r a t u r e R a n g e H i g h	
	T e m p e r a t u r e R a n g e H i g h	T e m p e r a t u r e R a n g e L o w to 1200°F (649°C)	
	P r e h e a t R e a d y F e a t u r e	Yes, No	
	R e a d y B a n d	1 to 1200°F (649°C)	
	R e a l T i m e C l o c k D i s p l a y	Yes, No	
	P o w e r L o s s M e n u R e s u m e	Yes, No	
	A l a r m s f o r c h a n n e l 1	None, Dev, Proc, Both	
	A b s o l u t e P r o c e s s A l a r m 1	100 to 1200°F (38 to 649°C)	
L o w D e v i a t i o n A l a r m 1	-999 to 0°F (-555 to 0°C)		
H i g h D e v i a t i o n A l a r m 1	0 to 999°F (0 to 555°C)		
T H E R M Thermal	T y p e Temperature Control Type	PID, On-Off	
	H y s t e r e s i s 1	1 to 99°F (1 to 55°C)	
	P I D U n i t s	SI, US	
	A u t o - t u n i n g 1	on, OFF	
	P r o p o r t i o n a l B a n d 1	1 to 999°F (1 to 555°C)	
	R e s e t (i n t e g r a l) G a i n 1	0.00 to 9.99 repeats/minute	
	I n t e g r a l G a i n 1	0.00 to 99.99 minutes/repeat	
	R a t e (d e r i v a t i v e) G a i n 1	0.00 to 9.99 minutes	
	D e r i v a t i v e G a i n 1	0.00 to 9.99 minutes	
	P I D C y c l e T i m e 1	1 to 60 seconds	
d i a g WatHelp Diagnostics	Used for equipment troubleshooting and testing. Not used when programming. See the <i>Hardware & Software Setup Guide</i> .		

Auto-tuning Note:

Before auto-tuning Application 15, **tENP 1** in the operations menu must first be set to a value that is typical of your application. (See *Hardware & Software Setup Guide* for information on programming menus.) Then set **tHERt / tUnE 1** to **on**. After you accept **on**, by pressing “Enter,” the controller will display **tUnE** while auto-tuning is taking place.

The controller will cancel the auto-tuning process if it cannot be completed in 80 minutes. You can cancel the auto-tuning process at any time by pressing either key C or key D and accepting **OFF**, by pressing “Enter,” when it appears.

Step 7 Design a Faceplate Overlay

To complete the installation, you must apply a graphic membrane to the front panel of the controller. The following artwork will help you design and create a membrane for this application. For more dimensions and guidelines, see the *Hardware & Software Setup Guide*.

Suggested End-user Overlay:

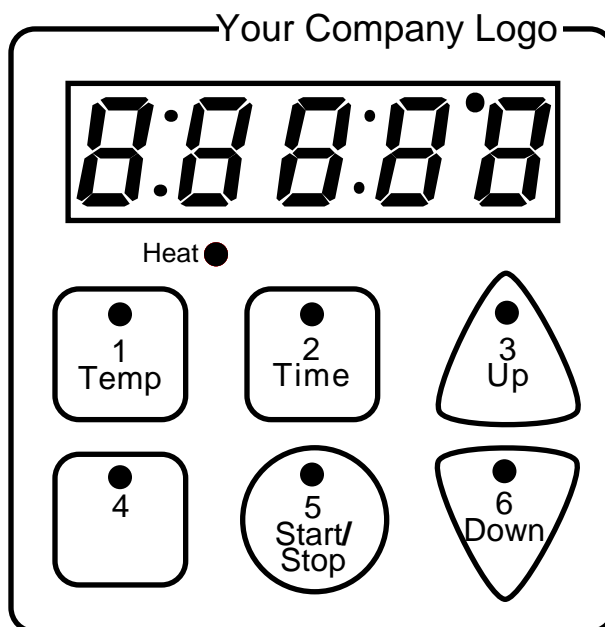

This Prototyping and Training Membrane Overlay will help you with the configuration and programming steps. To order it, see the Ordering Information at the back of this guide.

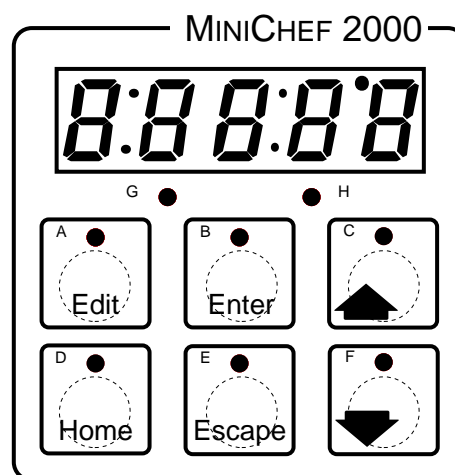

Step 8 Operate the Controller

Summary of Key Functions in Operation Mode

Key	Function
A	Temp
B	Time
C	Increment
D	Not Used
E	Start/Stop
F	Decrement

Startup

Apply power to the fryer and add cooking oil if necessary.

Set the Menu

Set the cooking temperature.

1. Press the Temp key **TEMP** and then the cooking temperature value will appear on the display.
2. Press the Up-arrow or Down-arrow key until the value you want appears on the display.
3. Press the Temp key again.

The cooking temperature has been set.

idle will appear on the display.

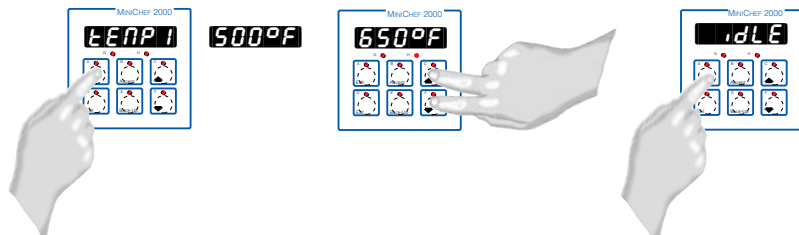

Set the cooking time.

1. Press the Time key **TIME** and then the cooking time value will appear on the display.
2. Press the Up-arrow or Down-arrow key until the value you want appears on the display.
3. Press the Time key again.

The cooking time has been set.

idle will appear on the display.

Five Second Timeout

When using the up or down keys to change a value, if you do not press any key for 5 seconds, the controller will automatically be set to the last value on the display and return to **idLE**.

Initial Preheat

At power-up, the unit will preheat to the temperature value set in the Configuration Mode **SETUP** / **rEAdy**. The display will show **PrE- HEAt** followed by oil temperature as the oil heats up.



When the unit reaches initial preheat temperature, **rEAdy** will flash once on the display and an audible tone will sound for 2 seconds. Then **idLE** will appear on the display. If the Real-time Clock option is installed and **SETUP** / **CLocK** is set to **YES**, the time of day will appear on the display.

If the preheat condition is met at power-up, the controller goes directly to idle, and does not display **rEAdy** or sound an audible tone.

Preheat

If in the Configuration Mode **SETUP** / **rEAdy** has been set to yes, the controller will detect temperatures and preheat to operating temperature (above relative set point minus the ready band) as required.

- Activate the current menu by pressing the Start/Stop key.

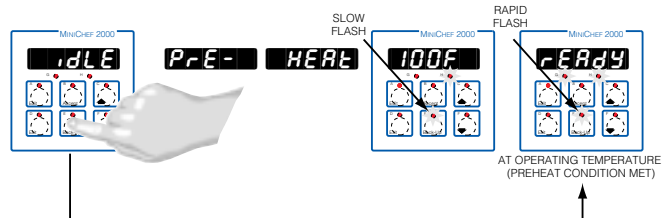

If the fryer is not at operating temperature, it will preheat. Meanwhile:

The word **PrE- HEAt** will appear on the display for a few moments. The Start/Stop key indicator light will flash slowly. The temperature of Channel 1 will be displayed until the operating temperature is reached.

The heat output indicator light - G, just below the display- will light up whenever the controller is calling for heat.

When the fryer is at operating temperature (above relative set point minus the ready band) **rEAdy** will appear on the display and the Start/Stop key indicator light will flash rapidly. You are now ready to cook with the active menu.

If the fryer is at operating temperature, the display goes directly to **rEAdy** without indicating preheat or temperature.

The Melt Cycle

To avoid burning congealed oil (shortening), a slow heating action may be necessary. If this is desired, be sure that in the Configuration Mode **HEATTYPE** / **PREHEAT** has been set to **ON**. Then, when the oil temperature is below 212°F the heat output will be limited to 10% of full power. This reduces the chance of burning congealed oil while it is heating.

Run a Menu (with preheat feature)

This procedure describes how to run an active menu when the preheat feature is active — in other words, when the **READY** parameter in the **SETUP** function of the Configuration Mode is set to **YES**.

1. Set the menu as shown earlier.
2. With **idle** or time of day on the display, press the Start/Stop key.

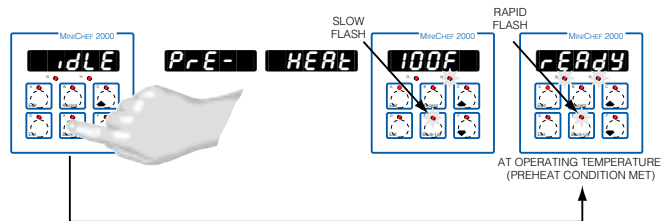

If the menu's preheat condition has not been met, the fryer will preheat until **rEAdy** appears on the display. If the fryer is at operating temperature, **rEAdy** will immediately appear on the display.

2. With **rEAdy** on the display, place the food in the pressure fryer and secure the lid on the pressure vessel.

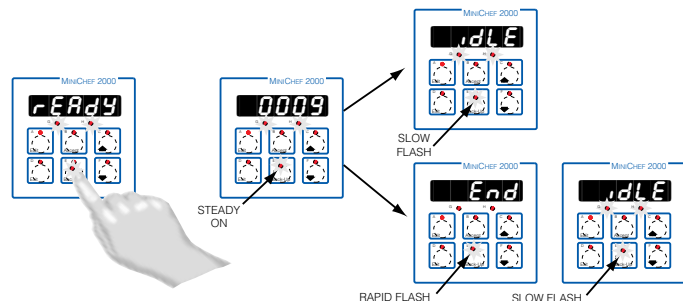

3. Press the Start/Stop key (indicated by the rapidly flashing indicator light).
The Start/Stop indicator light will light up. Time will count down on the display.
When the menu cycle nears completion, pressure will be released from the fryer based on the time programmed in Configuration Mode, **HEATTYPE** / **PREHEAT**.
4. When the cooking cycle is finished, the controller goes into idle and the Start/Stop key indicator light and heat output will switch off.
5. After pressure release time is complete, open lid and carefully and safely remove the food. The controller will continue to regulate at the last setpoint. The menu key indicator light will flash slowly.
6. To repeat cooking, repeat steps 1 through 5.

Run A Menu (without preheat feature)

This procedure describes how to run a menu when the preheat function is inactive — in other words, when the **rEAdy** parameter in the **SEtUP** function of the Configuration Mode is set to **no** — and initial preheat power-up has been completed.

1. With **idLE** on the display, place the food in the pressure fryer and secure the lid on the pressure vessel.

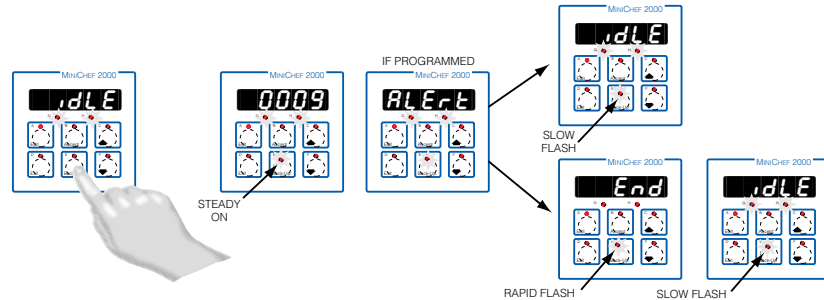

2. Press the Start/Stop key.
The Start/Stop indicator light will light up. Time will count down on the display. When the menu cycle nears completion, pressure will be released from the fryer based on the time programmed in Configuration Mode **EtYPE** / **Pt inE**.
3. When the cooking cycle is finished, the controller goes into idle and the Start/Stop key indicator light will switch off. The controller will continue to regulate the set point temperature.
4. Remove the food carefully and safely.
5. To repeat cooking, repeat steps 1 through 4.

Adjust a Menu While Cooking

You can adjust the temperature and time settings during the cooking and hold sequences by performing the actions shown under “Set the Menu” earlier in this section.

Changes can be made to temperature and time only during the portion of the cooking sequence in which they are active. For example: a change to the first cooking temperature **EtAP 1** can be made only when the first cooking temperature is being run during the cooking sequence.

Temperature changes made while cooking are saved and become part of the permanent menu. Time changes are not saved and do not become part of the permanent menu.

Event outputs

Event output 1 assists in controlling pressure.

Event output 1 will switch on when a menu starts and switch off when the time remaining is equal to the value programmed in the Configuration Mode under **EtYPE** / **Pt inE**.

If a menu is cancelled, Event output 1 switches off immediately.

Cancel a menu

Canceling the menu stops controller operation completely. The controller does not maintain set point temperatures or run time. Users may cancel the menu in order to run another one, to stop menu operation for any reason, or when preparing to shut off the fryer.

Press the Start/Stop for 2 seconds.

Heat outputs will switch off. Heat output indicator lights will switch off. The display presents **Idle** or the time of day will appear on the display.

Change menus or restart

1. Set menu as shown earlier.
2. Press Start/Stop key.

Temperature Alarms

The controller will alert you to temperature alarm conditions if they occur. If an alarm occurs, take action as determined by your supervisor. See the Appendix in the *Hardware & Software Setup Guide* for a Troubleshooting Chart and a summary of temperature alarms.

Errors

The controller will alert you to errors if they occur. Errors are critical problems that shut down the unit. If an error occurs, an error message will appear on the display. You should switch off the power and call for service.

See the Appendix in the *Hardware & Software Setup Guide* for a Troubleshooting Chart and a summary of errors.

Application 16 Automatic Deepfat Fryer

One Heat Channel, Six Menus

<i>Introduction to Application 16</i>	<i>65</i>
<i>Configuration Mode Quick Reference</i>	<i>67</i>
<i>Program Mode Quick Reference</i>	<i>68</i>
<i>Step 7 Design a Faceplate Overlay</i>	<i>69</i>
<i>Step 8 Operate the Controller</i>	<i>70</i>

Application 16 allows you to program as many as six menu keys to control one temperature channel and cooking time for an automatic deepfat fryer.

Overview of Key Steps

1. Install the MINICHEF 2000.
2. Wire the controller.
3. Configure the controller.
4. Program the menus.
5. Set the controller security.
6. Set the Real-time Clock.
For instructions on Steps 1, 2, 3, 4, 5 and 6, see the *Hardware & Software Setup Guide*.
7. Design, manufacture and apply faceplate overlay for end-users. (For a suggested design to suit this application, see this section. For overlay dimensions and guidelines, see the *Hardware & Software Setup Guide*.)
8. Operate the controller. (See this application guide.)

Key Functions in Configuration Mode



Key Functions in Operation Mode

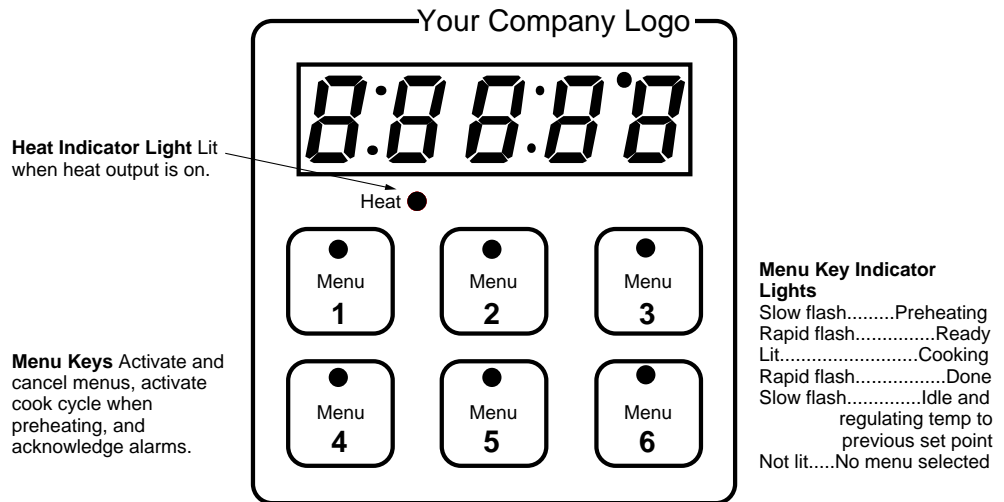

Summary of Input/Output Functions

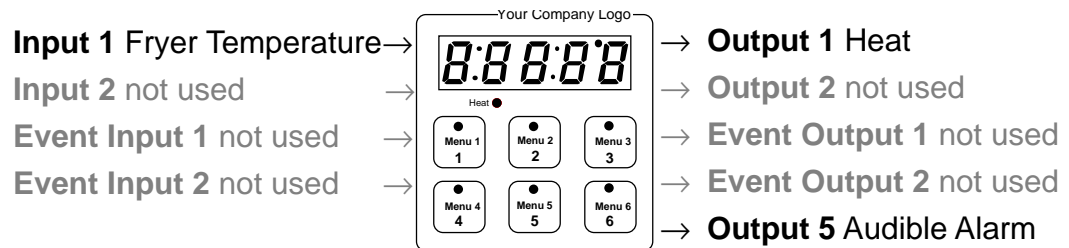

Note: For details, see wiring instructions in the *Hardware & Software Setup Guide*.

Configuration Mode Quick Reference

These are the functions, parameters and values included in the Configuration Mode for this application. You must select Application 16 to access them. For directions, see the *Hardware & Software Setup Guide*. The Appendix of that guide includes an explanation of all parameters and values.

Function	Parameter	Value	Your Settings
EEYPE Equipment-Type	APPL Application Number	1 - 28	16
	R_Loc Application Number Security Lock	Yes, No	
	Sound Audible Alarm Sound	0 - 5	
	PREHt Preheat Temperature	Temperature range low to range hi	
	MELT Oil Melt Cycle	On, Off	
SETUP Setup	CF Temperature Display Format	°C or °F	
	TIME Time Display Format	MMM:SS, HH:MM, H:MM:SS (H=Hours, M=Minutes, S=Seconds)	
	ChirP Key Chirp	On, Off	
	Loc Menu Security Lock	Yes, No	
	tc Thermocouple Type	J, K (shown as H), E	
	rtD RTD Curve	DIN, JIS	
	tcOnP WatCurve™ Temperature Compensation	On, Off	
	OFFSt 1 Temperature Offset, Channel 1	-99 to 99°F (-55 to 55°C)	
	Er Lo Temperature Range Low	0°F (-18°C) for RTD inputs, 32°F (0°C) for tc inputs to Er Hi	
	Er Hi Temperature Range High	Er Lo to 1200°F (649°C)	
	rEADy Preheat Ready Feature	Yes, No	
	rbAnd Ready Band	1 to 1200°F (649°C)	
	CLoc Real Time Clock Display	Yes, No	
	PLoss Power Loss Menu Resume	Yes, No	
	AL 1 Alarms for channel 1	None, Dev, Proc, Both	
	AL P 1 Absolute Process Alarm 1	100 to 1200°F (38 to 649°C)	
	AL dL 1 Low Deviation Alarm 1	-999 to 0°F (-555 to 0°C)	
	AL dH 1 High Deviation Alarm 1	0 to 999°F (0 to 555°C)	
	THErL Thermal	TYPE Temperature Control Type	PID, On-Off
		HYSSt 1 Hysteresis 1	1 to 99°F (1 to 55°C)
Pid U PID Units		SI, US	
tunE 1 Auto-tuning 1		on, OFF	
ProP 1 Proportional Band 1		1 to 999°F (1 to 555°C)	
rSEt 1 Reset (integral) Gain 1		0.00 to 9.99 repeats/minute	
int 1 Integral Gain 1		0.00 to 99.99 minutes/repeat	
rAtE 1 Rate (derivative) Gain 1		0.00 to 9.99 minutes	
dEr 1 Derivative Gain 1		0.00 to 9.99 minutes	
CyCL 1 PID Cycle Time 1		1 to 60 seconds	
d,AG WatHelp Diagnostics	Used for equipment troubleshooting and testing. Not used when programming. See the <i>Hardware & Software Setup Guide</i> .		

Program Mode Quick Reference

These are the functions, parameters and values included in the Program Mode for this application. You must select Application 16 to access them. For menu programming directions, see the *Hardware & Software Setup Guide*. The Appendix of that guide includes a detailed explanation of all parameters and values.

Function	Parameter	Value	Your Settings
P7 Menu Numbers 1 - 6	SETE1 Set point 1 Temperature of set point 1.	Temperature range low to range high.	
	TIME1 Time 1 Run time of set point 1.	Format varies based on configuration.	
	ALARM Mid-menu Alarm	Stir, Add, Flip, Turn, Alert, None	
	ALt1nE Mid-menu alarm time.	0 to TIME1 .	

Auto-tuning Note:

Before auto-tuning Application 16, the Set Point 1 of Menu 1 must first be set to a value that is typical of your application. (See *Hardware & Software Setup Guide* for information on programming menus.) Then set **tHErL** / **tunE1** to **on**. After you accept **on**, by pressing “Enter,” the controller will display **tunE** while auto-tuning is taking place.

The controller will cancel the auto-tuning process if it cannot be completed in 80 minutes. You can cancel the auto-tuning process at any time by pressing either key C or key D and accepting **OFF**, by pressing “Enter,” when it appears.

Step 7 Design a Faceplate Overlay

To complete the installation, you must apply a graphic membrane to the front panel of the controller. The following artwork will help you design and create a membrane for this application. For more dimensions and guidelines, see the *Hardware & Software Setup Guide*.

Suggested End-user Overlay:

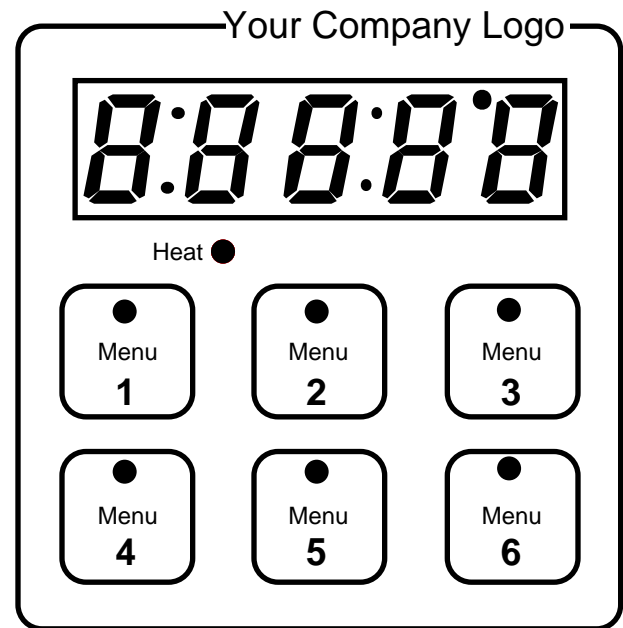

This Prototyping and Training Membrane Overlay will help you with the configuration and programming steps. To order it, see the Ordering Information at the back of this guide.



Step 8 Operate the Controller

Summary of Key Functions in Operation Mode

Key	Function
A	Menu 1
B	Menu 2
C	Menu 3
D	Menu 4
E	Menu 5
F	Menu 6

Startup

Apply power to the fryer and add cooking oil if necessary.

Initial Preheat

At power-up, the unit will preheat to the temperature value set in the Configuration Mode **SETUP** / **PREHE**. The display will show **PRE- HEAT** followed by oil temperature as the oil heats up.



When the unit reaches initial preheat temperature, **rEAdy** will flash once on the display and an audible tone will sound for 2 seconds. Then **idLE** will appear on the display. If the Real-time Clock option is installed and **SETUP** / **CLoc** is set to **YES**, the time of day will appear on the display.

If the preheat condition is met before power-up, the controller goes directly to idle, and does not display **rEAdy** or sound an audible tone.

Preheat

If in the Configuration Mode **SETUP** / **rEAdy** has been set to yes, the controller will detect temperatures and preheat to operating temperature (above relative set point minus the ready band) as required.

- Activate the menu by pressing the menu key.

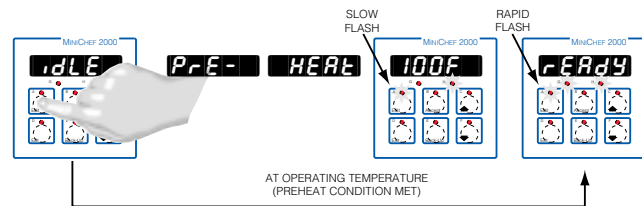

If the fryer is not at operating temperature, it will preheat. Meanwhile:

The word **PrE- HEAt** will appear on the display for a few moments. The menu key indicator light will flash slowly. The temperature of Channel 1 will then be displayed until the operating temperature is reached.

The heat output indicator light - G, just below the display- will light up whenever the controller is calling for heat.

When the fryer is at operating temperature (above relative set point minus the ready band) **rEAdy** will appear on the display and the menu key indicator light will flash rapidly. You are now ready to cook with the active menu.

If the fryer is at operating temperature, the display goes directly to **rEAdy** without indicating preheat or temperature.

The Melt Cycle

To avoid burning congealed oil (shortening), a slow heating action may be necessary. If this is desired, be sure that in the Configuration Mode **EEtYPE / P7tELL** has been set to **on**. Then, when the oil temperature is below 212 °F the heat output will be limited to 10% of full power. This reduces the chance of burning congealed oil while it is heating.

Run a Menu (with preheat feature)

This procedure describes how to run an active menu when the preheat feature is active — in other words, when the **rEAdy** parameter in the **SEtUP** function of the Configuration Mode is set to **YES**.

1. With **idle** on the display, press the key for the menu you want to run.

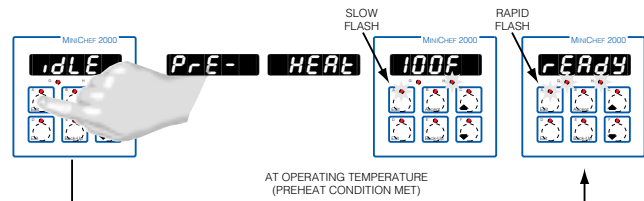

If the selected menu's preheat condition has not been met, the fryer will preheat until **rEAdy** appears on the display. If the fryer is at operating temperature **rEAdy** will immediately appear on the display.

2. With **rEAdy** on the display, place the food in the fryer and press the action menu key (indicated by the flashing red light.) The menu key indicator light will light up. Time will count down on the display.

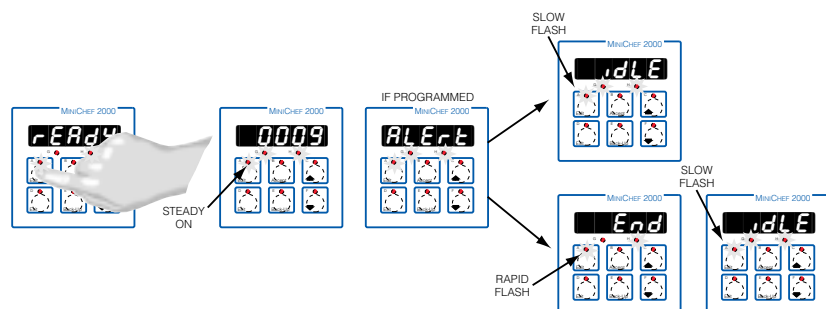

3. If programmed, as the time counts down, a mid-menu alarm message will appear on

the display. (The message, which varies based on programming at **P9** / **ALArn** will appear for ten seconds.)

An audible tone will sound for five seconds. Time will continue to count down on the display.

4. When the cooking cycle is finished one of the following will happen, depending on the way the controller was programmed at **ETYPE** / **Sound**.

With Sound set to 0: The controller automatically switches to idle, where the controller maintains the temperatures at set point and does not run time. **idle** or time of day will appear on the display. The menu key indicator light will flash slowly.

With Sound set to 1, 2, or 3, **End** will appear on the display and an audible tone will be emitted. The menu key indicator light will flash rapidly. You can acknowledge and silence the tone by pressing the active menu key or it will time out in 1 to 20 seconds and go into idle. The menu key indicator light will flash slowly.

With Sound set to 4 or 5, **End** will appear on the display and the menu key indicator light will flash rapidly. You must acknowledge the audible tone by pressing the active menu key. Once acknowledged, the tone is silenced and the controller goes into idle. The menu key indicator light will flash slowly.

5. Remove the food from the fryer. The controller will continue to regulate to the last set point. The menu key indicator light will flash slowly.
6. To repeat cooking, repeat steps 1 through 5.

Run a Menu (without preheat feature)

This procedure describes how to run a menu when the preheat function is inactive — that is, when the **rEADY** parameter in the **SETUP** function of the Configuration Mode is set to **no** — and initial preheat power-up has been completed.

1. With **idle** on the display, place the food in the fryer.

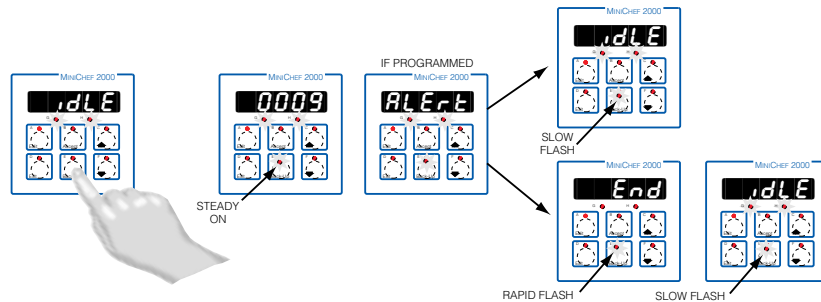

2. Press the key for the menu you want to run. The menu key will light up and then time will count down on the display:

3. If programmed, as the time counts down, a mid-menu alarm message **P9** / **ALArn** will appear on the display.

The alarm message, which varies based on programming, will appear for ten seconds.

An audible tone will sound for five seconds. Time will continue to count down on the display.

4. When the cooking cycle is finished one of the following will happen, depending on

the way the controller was programmed at **ETYPE** / **Sound**:

With Sound set to 0: The controller automatically switches to idle, where the controller maintains the temperatures at set point and does not run time. **idLE** or time of day will appear on the display. The menu key indicator light will flash slowly.

With Sound set to 1, 2, or 3: **End** will appear on the display and an audible tone will be emitted. The menu key indicator light will flash rapidly. You can acknowledge and silence the tone by pressing the active menu key or it will time out in 1 to 20 seconds and go into idle. The menu key indicator light will flash slowly.

With Sound set to 4 or 5: **End** will appear on the display and the menu key indicator light will flash rapidly. You must acknowledge the audible tone by pressing the active menu key. Once acknowledged the tone is silenced and the controller goes into idle. The menu key indicator light will flash slowly.

5. Remove the food from the fryer. The controller will continue to regulate at the last set point. The menu indicator light will flash slowly.
6. To repeat cooking, repeat steps 1 through 5.

Cancel a Menu

Canceling a menu stops controller operation completely. The controller does not maintain set point temperatures or run time. Users may cancel a menu in order to run another one, to stop menu operation for any reason, or when preparing to shut off the fryer.

- Press the active menu key for 2 seconds.
Heat outputs will switch off. Heat output indicator lights will switch off. The display presents **idLE** or the time of day will appear on the display.

Change or Restart Menus

- With the controller in idle, press the key for the menu you want to run.

Temperature Alarms

The controller will alert you to temperature alarm conditions if they occur. If an alarm occurs, take action as determined by your supervisor. See the Appendix in the *Hardware & Software Setup Guide* for a Troubleshooting Chart and a summary of temperature alarms.

Errors

The controller will alert you to errors if they occur. Errors are critical problems that shut down the unit. If an error occurs, an error message will appear on the display. You should switch off the power and call for service.

See the Appendix in the *Hardware & Software Setup Guide* for a Troubleshooting Chart and a summary of errors.

Notes

Application 17

Automatic Deepfat Fryer

One Heat Channel, Four Menus

<i>Introduction to Application 17</i>	75
<i>Configuration Mode Quick Reference</i>	77
<i>Program Mode Quick Reference</i>	78
<i>Step 7 Design a Faceplate Overlay</i>	79
<i>Step 8 Operate the Controller</i>	80

Application 17 allows you to program as many as four menu keys to control one temperature channel and dual cooking time for an automatic deepfat fryer.

Overview of Key Steps

1. Install the MINICHEF 2000.
2. Wire the controller.
3. Configure the controller.
4. Program the menus.
5. Set the controller security.
6. Set the Real-time Clock.
For instructions on Steps 1, 2, 3, 4, 5 and 6, see the *Hardware & Software Setup Guide*.
7. Design, manufacture and apply faceplate overlay for end-users. (For a suggested design to suit this application, see this section. For overlay dimensions and guidelines, see the *Hardware & Software Setup Guide*.)
8. Operate the controller. (See this application guide.)

Key Functions in Configuration Mode



Key Functions in Operation Mode

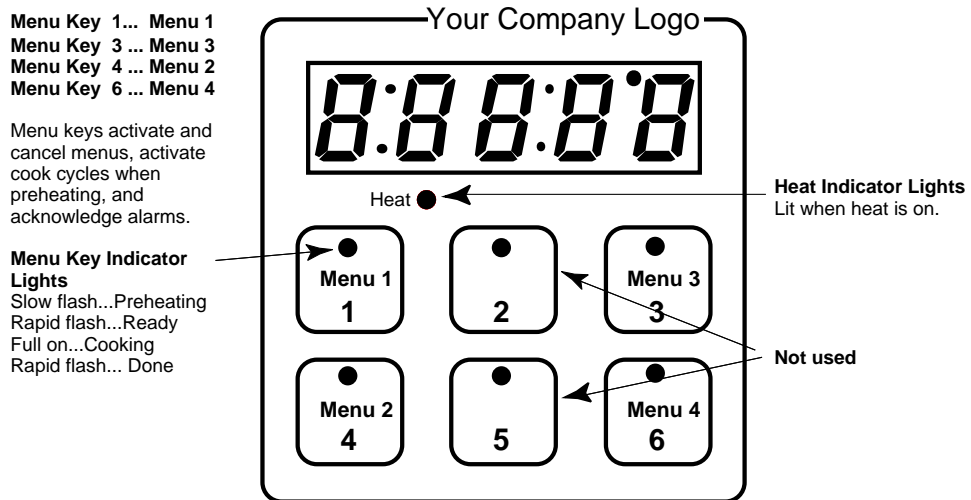

Summary of Input/Output Functions

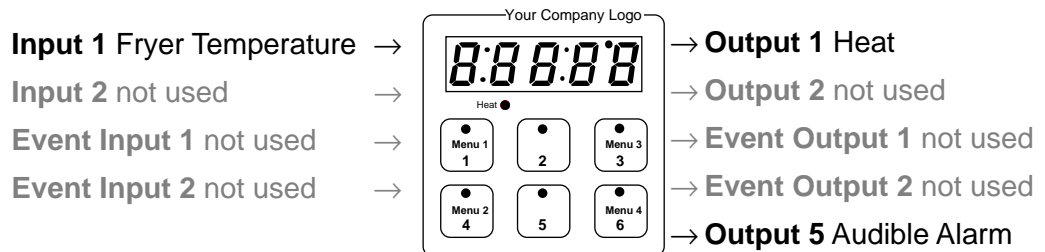

Note: For details, see wiring instructions in the *Hardware & Software Setup Guide*.

Configuration Mode Quick Reference

These are the functions, parameters and values included in the Configuration Mode for this application. You must select Application 17 to access them. For directions, see the *Hardware & Software Setup Guide*. The Appendix of that guide includes an explanation of all parameters and values.

Function	Parameter	Value	Your Settings
E E Y P E Equipment-Type	A P P L Application Number	1 - 28	17
	A _ L o c Application Number Security Lock	Yes, No	
	S o u n d Audible Alarm Sound	0 - 5	
	M e l t Oil Melt Cycle	On, Off	
	S e t P t Set point	E r L o to E r H i	
	S E T U P Setup	C _ F Temperature Display Format	
T i m e Time Display Format		MMM:SS, HH:MM, H:MM:SS (H=Hours, M=Minutes, S=Seconds)	
C h i r p Key Chirp		On, Off	
L o c Menu Security Lock		Yes, No	
t c Thermocouple Type		J, K (shown as H), E	
r t d RTD Curve		DIN, JIS	
t c o n p WatCurve™ Temperature Compensation		On, Off	
O F S e t 1 Temperature Offset, Channel 1		-99 to 99°F (-55 to 55°C)	
E r L o Temperature Range Low		0°F (-18° C) for RTD inputs 32°F (0°C) for tc inputs to E r H i	
E r H i Temperature Range High		E r L o to 1200°F(649°C)	
r e a d y Preheat Ready Feature		Yes, No	
r b a n d Ready Band		1 to 1200°F (649°C)	
C l o c Real Time Clock Display		Yes, No	
P L O S S Power Loss Menu Resume		Yes, No	
A L 1 Alarms for channel 1		None, Dev, Proc, Both	
A L P 1 Absolute Process Alarm 1		100 to 1200°F (38 to 649°C)	
A L d L 1 Low Deviation Alarm 1		-999 to 0°F (-555 to 0°C)	
A L d H 1 High Deviation Alarm 1	0 to 999°F (0 to 555°C)		
T H E R M Thermal	T Y P E Temperature Control Type	PID, On-Off	
	H Y S T 1 Hysteresis 1	1 to 99°F (1 to 55°C)	
	P i d U PID Units	SI, US	
	t u n e 1 Auto-tuning 1	on, OFF	
	P r o P 1 Proportional Band 1	1 to 999°F (1 to 555°C)	
	r S E T 1 Reset (integral) Gain 1	0.00 to 9.99 repeats/minute	
	i n t 1 Integral Gain 1	0.00 to 99.99 minutes/repeat	
	r A T E 1 Rate (derivative) Gain 1	0.00 to 9.99 minutes	
	d E r 1 Derivative Gain 1	0.00 to 9.99 minutes	
	C y c L 1 PID Cycle Time 1	1 to 60 seconds	
d i A G WatHelp Diagnostics	Used for equipment troubleshooting and testing. Not used when programming. See the <i>Hardware & Software Setup Guide</i> .		

Program Mode Quick Reference

These are the functions, parameters and values included in the Program Mode for this application. You must select Application 17 to access them. For menu programming directions, see the *Hardware & Software Setup Guide*. The Appendix of that guide includes a detailed explanation of all parameters and values

Function	Parameter	Value	Your Settings
P7 Menu Numbers 1 - 4	T1 Time 1 Run time of set point.	Format varies based on configuration.	
	ALARM Mid-menu Alarm	Stir, Add, Flip, Turn, Alert, None	
	ALTIME Mid-menu alarm time.	0 to T1 .	

Auto-tuning Note:

Before auto-tuning Application 17, set point parameter at **ETYPE** / **SETPt** must first be set to a value that is typical of your application. (See the *Hardware & Software Setup Guide* for information on programming menus.) Then set **TEMP** / **TUNE 1** to **on**. After you accept **on**, by pressing “Enter,” the controller will display **TUNE** while auto-tuning is taking place.

The controller will cancel the auto-tuning process if it cannot be completed in 80 minutes. You can cancel the auto-tuning process at any time by pressing either key C or key D and accepting **OFF**, by pressing “Enter,” when it appears.

Step 7 Design a Faceplate Overlay

To complete the installation, you must apply a graphic membrane to the front panel of the controller. The following artwork will help you design and create a membrane for this application. For more dimensions and guidelines, see the *Hardware & Software Setup Guide*.

Suggested End-user Overlay:

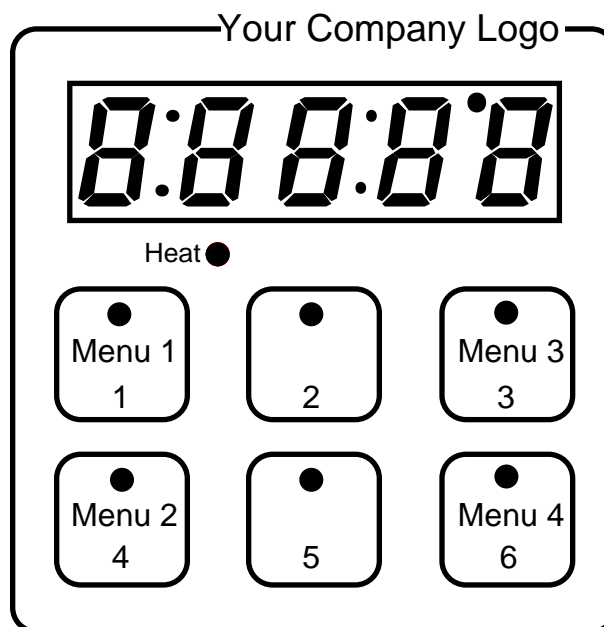

This Prototyping and Training Membrane Overlay will help you with the configuration and programming steps. To order it, see the Ordering Information at the back of this guide.

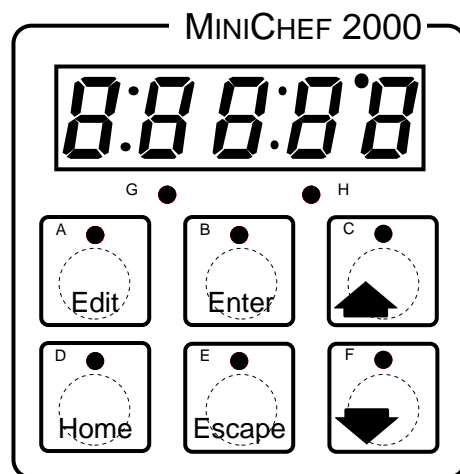

Step 8 Operate the Controller

Summary of Key Functions in Operation Mode

Key	Function
A	Menu 1
B	Not Used
C	Menu 2
D	Menu 3
E	Not Used
F	Menu 4

Startup

Apply power to the fryer and add cooking oil if necessary.

Initial Preheat

At power-up, the unit will preheat to the temperature value set in the Configuration Mode **TEMP** / **SETP**. The display will show **PRE-HEAT** followed by oil temperature as the oil heats up.



When the unit reaches initial preheat temperature, **rEAdy** will flash once on the display and an audible tone will sound for 2 seconds. Then **idLE** will appear on the display. If the Real-time Clock option is installed and **SETUP / CLoc** is set to **YES**, the time of day will appear on the display.

If the preheat condition is met before power-up, the controller goes directly to idle, and does not display **rEAdy** or sound an audible tone.

Preheat

If in the Configuration Mode **SETUP / rEAdy** has been set to yes, the controller will detect temperatures and preheat to operating temperature (above relative set point minus the ready band) as required.

- Activate the menu by pressing the desired menu key.

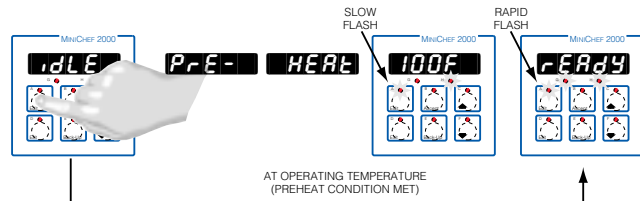

If the fryer is not at operating temperature, it will preheat. Meanwhile:

The word **PRE-HEAT** will appear on the display for a few moments. The menu key indicator light will flash slowly. The temperature of Channel 1 will be displayed until the operating temperature is reached.

The heat output indicator light – G, just below the display – will light up whenever the controller is calling for heat.

When the fryer is at operating temperature (above relative set point minus the ready band) **READY** will appear on the display and the menu key indicator light will flash rapidly. You are now ready to cook with the active menu.

If the fryer is at operating temperature, the display goes directly to **READY** without indicating preheat or temperature.

The Melt Cycle

To avoid burning congealed oil (shortening), a slow heating action may be necessary. If this is desired, be sure that in the Configuration Mode **TYPE / MELT** has been set to **on**. Then, when the oil temperature is below 212 °F the heat output will be limited to 10% of full power. This reduces the chance of burning congealed oil while it is heating.

Run a Menu

1. With **idle** on the display, place the food in the fryer and press the key(s) for the menu(s) you want to run. The menu key indicator light(s) that you selected will light up. You will be able to select only two menus to run simultaneously. Menu 1 can be active with either 3 or 4, or Menu 2 can be active with either 3 or 4. The remaining time for the menu with the shortest countdown time will be shown on the display.

If the preheat condition has not been met you will not be able to select a menu until **READY** flashes once on the display followed by **idle**. If the fryer is at operating temperature **idle** will immediately appear on the display.

2. If programmed, as the time counts down, a mid-menu alarm message will appear on the display. (The message, which varies based on programming at **PR -- / ALARM** will appear for ten seconds.)

An audible tone will sound for five seconds. Time will continue to count down on the display.

3. When a menu cycle is finished one of the following will happen, depending on the way the controller was programmed at **TYPE / Sound**:

With Sound set to 0: The controller displays **End** and the menu key indicator light will flash rapidly until acknowledged, by pressing that key. The controller maintains the temperatures at set point and displays the remaining time of the menu with the shortest countdown time. If there are no running menus, **idle** or time of day will appear on the display.

With Sound set to 1, 2, or 3, **End** will appear on the display and an audible tone will be emitted. The menu key indicator light will flash rapidly. You can acknowledge and silence the tone by pressing the active menu key or it will time out in 1 to 20 seconds and go into idle.

With Sound set to 4 or 5, **End** will appear on the display and the menu key indicator light will flash rapidly. You must acknowledge the audible tone by pressing the active menu key. Once acknowledged, the tone is silenced and the controller goes into idle.

4. Remove the food from the fryer. The controller will continue to regulate to the set point. The menu key indicator light will be off.
5. To repeat cooking, repeat steps 1 through 4.

Cancel a Menu

Canceling a menu stops controller timing for that menu. The controller may still be running time for another menu. Users may cancel a menu in order to run another one, to stop menu operation for any reason, or when preparing to shut off the fryer.

- Press the active menu key for 2 seconds.

The display presents time remaining if another menu is active, otherwise **idle** or the time of day.

Change or Restart Menus

- With the controller in idle, press the key for the menu you want to run.

Temperature Alarms

The controller will alert you to temperature alarm conditions if they occur. If an alarm occurs, take action as determined by your supervisor. See the Appendix in the *Hardware & Software Setup Guide* for a Troubleshooting Chart and a summary of temperature alarms.

Errors

The controller will alert you to errors if they occur. Errors are critical problems that shut down the unit. If an error occurs, an error message will appear on the display. You should switch off the power and call for service.

See the Appendix in the *Hardware & Software Setup Guide* for a Troubleshooting Chart and a summary of errors.

Application 18 Automatic Deepfat Fryer

One Heat Channel, 40 Menus

<i>Introduction to Application 18</i>	<i>83</i>
<i>Configuration Mode Quick Reference</i>	<i>85</i>
<i>Program Mode Quick Reference</i>	<i>86</i>
<i>Step 7 Design a Faceplate Overlay</i>	<i>87</i>
<i>Step 8 Operate the Controller</i>	<i>88</i>

Application 18 allows you to program as many as forty menus to control one temperature channel and cooking time for an automatic deepfat fryer.

Overview of Key Steps

1. Install the MINICHEF 2000.
2. Wire the controller.
3. Configure the controller.
4. Program the menus.
5. Set the controller security.
6. Set the Real-time Clock.
For instructions on Steps 1, 2, 3, 4, 5 and 6, see the *Hardware & Software Setup Guide*.
7. Design, manufacture and apply faceplate overlay for end-users. (For a suggested design to suit this application, see this section. For overlay dimensions and guidelines, see the *Hardware & Software Setup Guide*.)
8. Operate the controller. (See this application guide.)

Key Functions in Configuration Mode



Key Functions in Operation Mode

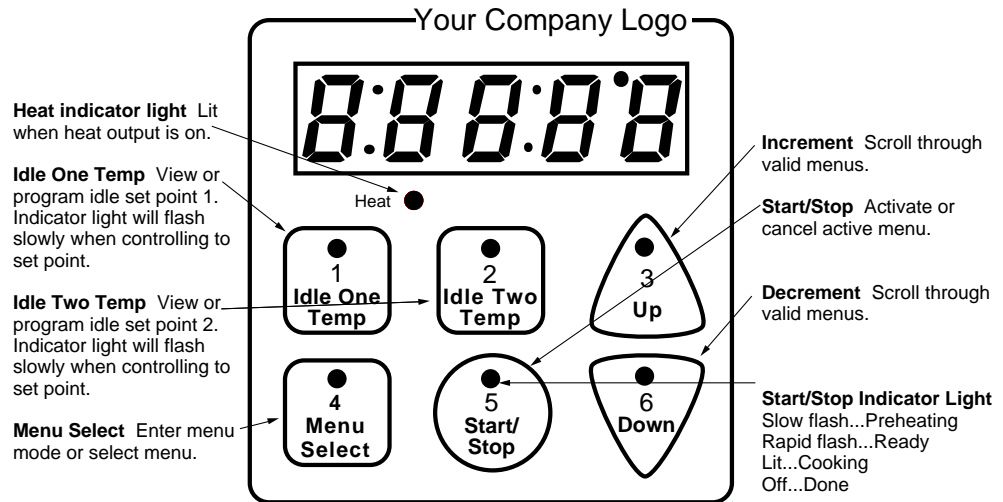

Summary of Input/Output Functions

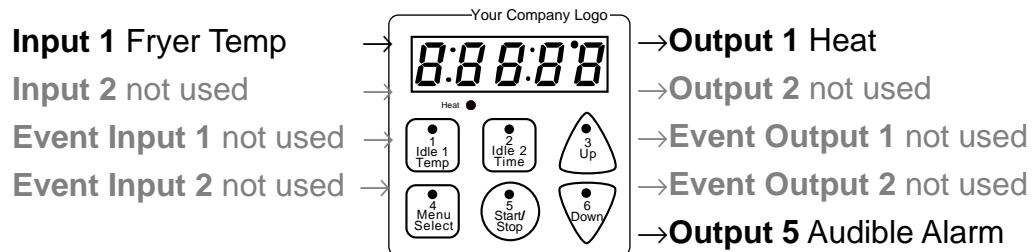

Note: For details, see wiring instructions in the *Hardware & Software Setup Guide*.

Configuration Mode Quick Reference

These are the functions, parameters and values included in the Configuration Mode for this application. You must select Application 18 to access them. For directions, see the *Hardware & Software Setup Guide*. The Appendix of that guide includes an explanation of all parameters and values.

Function	Parameter	Value	Your Settings	
E_{TYPE} Equipment-Type	APPL Application Number	1 - 28	18	
	A_{Loc} Application Number Security Lock	Yes, No		
	Sound Audible Alarm Sound	0 - 5		
	PREHT Initial Preheat Temperature	Temp range low to temp range high		
	idLE1 Channel 1 Idle Temperature	Temp range low to temp range high		
	idLE2 Channel 2 Idle Temperature	Temp range low to temp range high		
	PMELT Oil Melt Cycle	On, Off		
	S_{ETUP} Setup	CF Temperature Display Format		°C or °F
		TIME Time Display Format		MMM:SS, HH:MM, H:MM:SS (H=Hours, M=Minutes, S=Seconds)
		Chirp Key Chirp		On, Off
		Loc Menu Security Lock		Yes, No
		TC Thermocouple Type		J, K (shown as H), E
		RTD RTD Curve		DIN, JIS
		WATCONP WatCurve™ Temperature Compensation		On, Off
OFFSET1 Temperature Offset, Channel 1		-99 to 99°F (-55 to 55°C)		
ErLo Temperature Range Low		0°F (-18°C) for RTD inputs 32°F (0°C) for tc inputs to ErHi		
ErHi Temperature Range High		ErLo to 1200°F(649°C)		
READY Preheat Ready Feature		Yes, No		
RBAND Ready Band		1 to 1200°F (649°C)		
CLoc Real Time Clock Display		Yes, No		
PLOSS Power Loss Menu Resume		Yes, No		
T_{HERM} Thermal	AL1 Alarms for channel 1	None, Dev, Proc, Both		
	ALPI Absolute Process Alarm 1	100 to 1200°F (38 to 649°C)		
	ALDL1 Low Deviation Alarm 1	-999 to 0°F (-555 to 0°C)		
	ALDH1 High Deviation Alarm 1	0 to 999°F (0 to 555°C)		
	TYPE Temperature Control Type	PID, On-Off		
	HYS1 Hysteresis 1	1 to 99°F (1 to 55°C)		
	PIDU PID Units	SI, US		
	TUNE1 Auto-tuning 1	on, OFF		
	PROP1 Proportional Band 1	1 to 999°F (1 to 555°C)		
	RSET1 Reset (integral) Gain 1	0.00 to 9.99 repeats/minute		
DIAG WatHelp Diagnostics	int1 Integral Gain 1	0.00 to 99.99 minutes/repeat		
	RATE1 Rate (derivative) Gain 1	0.00 to 9.99 minutes		
	DER1 Derivative Gain 1	0.00 to 9.99 minutes		
	CYCL1 PID Cycle Time 1	1 to 60 seconds		
	Used for equipment troubleshooting and testing. Not used when programming. See the <i>Hardware & Software Setup Guide</i> .			

Program Mode Quick Reference

These are the functions, parameters and values included in the Program Mode for this application. You must select Application 18 to access them. For menu programming directions, see the *Hardware & Software Setup Guide*. The Appendix of that guide includes a detailed explanation of all parameters and values.

Function	Parameter	Value	Your Settings
PP Menu Numbers 1 - 6	SETE1 Set point 1 Temperature of set point 1.	Temperature range low to range high.	
	TIME1 Time 1 Run time of set point.	Format varies based on configuration.	
	ALARM Mid-menu Alarm	Stir, Add, Flip, Turn, Alert, None.	
	ALTIME Mid-menu alarm time.	0 to TIME1 .	

Auto-tuning Note:

Before auto-tuning Application 18, Set Point 1 of Menu 1 must first be set to a value that is typical of your application. (See *Hardware & Software Setup Guide* for information on programming menus.) Then set **TEMP1** / **TIME1** to **on**. After you accept **on**, by pressing “Enter,” the controller will display **tune** while auto-tuning is taking place.

The controller will cancel the auto-tuning process if it cannot be completed in 80 minutes. You can cancel the auto-tuning process at any time by pressing either key C or key D and accepting **OFF**, by pressing “Enter,” when it appears.

Step 7 Design a Faceplate Overlay

To complete the installation, you must apply a graphic membrane to the front panel of the controller. The following artwork will help you design and create a membrane for this application. For more dimensions and guidelines, see the *Hardware & Software Setup Guide*.

Suggested End-user Overlay:

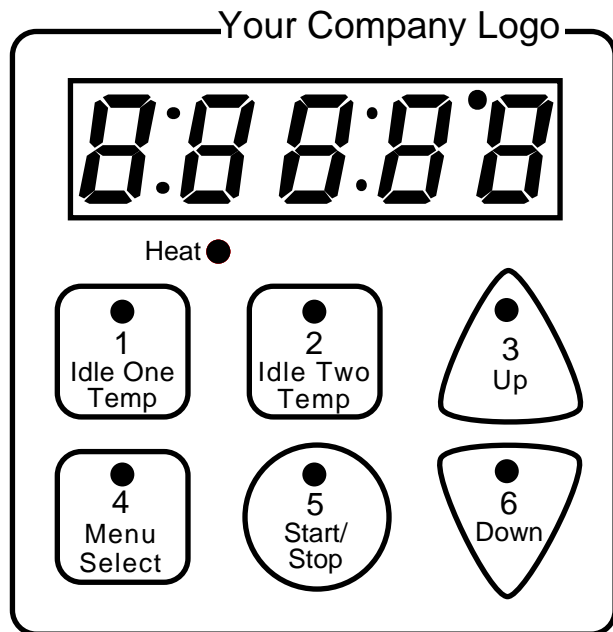

This Prototyping and Training Membrane Overlay will help you with the configuration and programming steps. To order it, see the Ordering Information at the back of this guide.



Step 8 Operate the Controller

Summary of Key Functions in Operation Mode

Key	Operation Function
A	Idle One Temp
B	Idle Two Temp
C	Increment
D	Menu Select
E	Start/Stop
F	Decrement

Start-up

Apply power to the fryer and add cooking oil if necessary.

Select a Menu

1. Press the Menu Select key.

The controller will display the currently selected menu. If no menus have been programmed the word **none** will appear on the display.

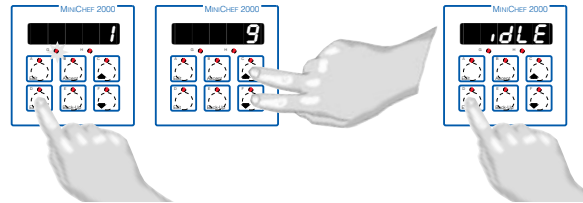

2. Press the Up-arrow or Down-arrow key until the menu you want appears on the display.

The controller will only display valid menus (those for which Time1 for the menu is set to greater than 0).

3. Press the Menu Select key again.

The menu you have chosen becomes the current menu for controller operation.

Initial Preheat

At power-up, the unit will preheat to the temperature value set in the Configuration Mode **TEMP** / **PREHEAT**. The display will show **PRE-** **HEAT** followed by oil temperature as the oil heats.



When the unit reaches initial preheat temperature, **READY** will flash once on the display.

play and an audible tone will sound for 2 seconds. Then **idLE** will appear on the display. If Real Time Clock option is installed and **SETUP / CLoc** is set to **YES**, the time of day will appear on the display.

Preheat

If in the Configuration Mode **SETUP / rEAdy** has been set to yes, the controller will detect temperatures and preheat to operating temperature (above relative set point minus the ready band) as required.

- Activate the menu by pressing the Start/Stop key.

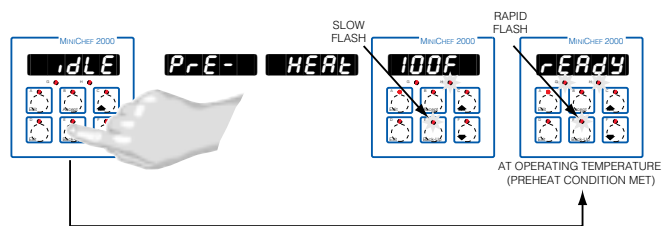

If the fryer is not at operating temperature, it will preheat. Meanwhile:

The word **PrE- HEAT** will appear on the display for a few moments. The Start/Stop key indicator light will flash slowly. The temperature of Channel 1 will be displayed until the operating temperature is reached.

The heat output indicator light – G, just below the display – will light up whenever the controller is calling for heat.

When the fryer is at operating temperature (above relative set point minus the ready band) **rEAdy** will appear on the display and the Start/Stop key indicator light will flash rapidly. You are now ready to cook with the active menu.

If the fryer is at operating temperature, the display goes directly to **rEAdy** without indicating preheat or temperature.

The Melt Cycle

To avoid burning, congealed oil requires a slow heating action. If in the Configuration Mode, **ELyPE / rMELT** has been set to on, when the oil temperature is below 212°F the heat output will be limited to 10% of full power.

Run a Menu (with preheat feature)

This procedure describes how to run an active menu when the preheat feature is active — in other words, when the **rEAdy** parameter in the **SETUP** function of the Configuration Mode is set to **YES**.

1. Select the menu you want to run as shown earlier in “Select a Menu”.
2. With **idLE** or time of day on the display, press the Start/Stop key.

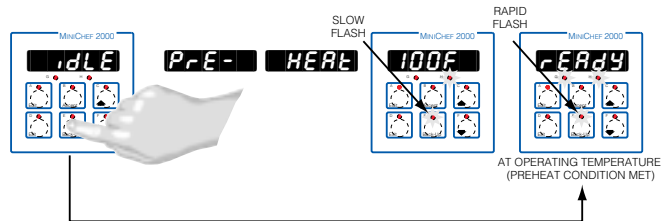

If the preheat condition has not been met, the fryer will preheat until **READY** appears on the display. If the fryer is at operating temperature **READY** will immediately appear on the display.

- With ready on the display, place the food in the fryer.

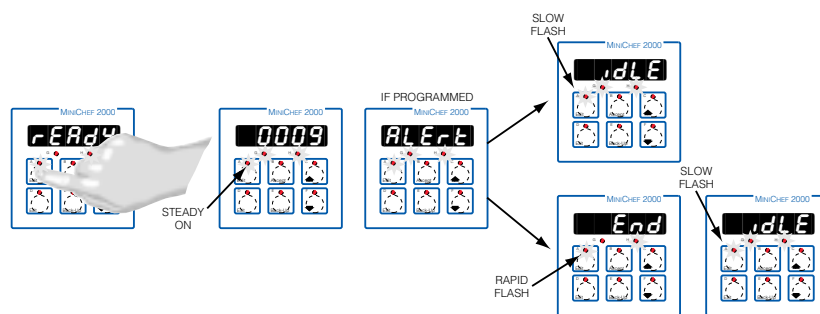

- Press the Start/Stop key.
The Start/Stop key indicator light will light up. Time will count down on the display.
- If programmed, as the time counts down, a mid-point alarm will appear on the display.
The alarm messages which varies based on programming will appear for ten seconds.
An audible will sound for five seconds. Time will continue to count down on the display.
- When the cooking cycle is finished one of the following will happen, depending on the way the controller was programmed at **ETYPE** / **Sound**:

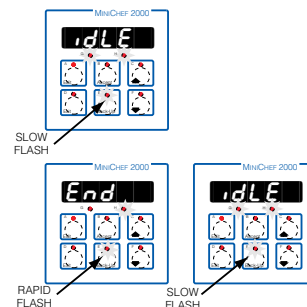

With Sound set to 0: The controller automatically switches to idle. **Idle** or current time will appear on the display. The Start/Stop key indicator light will flash slowly. The controller will maintain temperature at the programmed set point.

With Sound set to 1, 2, or 3: **End** will appear on the display and an audible tone will be emitted. The Start/Stop key indicator light will flash rapidly. You can

acknowledge and silence the tone by pressing the Start/Stop key or it will automatically time out within 2 seconds for setting 1 or 20 seconds for settings 2 or 3 and then go into idle. The Start/Stop key indicator light will flash slowly. The controller will maintain temperature at the programmed set point.

With sound set to 4 or 5: **End** will appear on the display and the Start/Stop key indicator light will flash rapidly. You must acknowledge the audible tone by pressing the Start/Stop key. Once acknowledged the audible tone is silenced and the controller goes into idle. The Start/Stop key indicator light will flash slowly. The controller will maintain temperature at the programmed set point.

7. Remove the food from the fryer.
8. To repeat cooking, repeat steps 1 through 7.

Run a Menu (with no preheat feature)

This procedure describes how to run an active menu when the preheat feature is inactive - in other words, when the **PREHEAT** parameter in the **SETUP** function of the Configuration Mode is set to **no**.

1. Select the menu you want to run as shown earlier in “Select a Menu”.
2. With **idle** or time of day on the display, place the food in the basket.

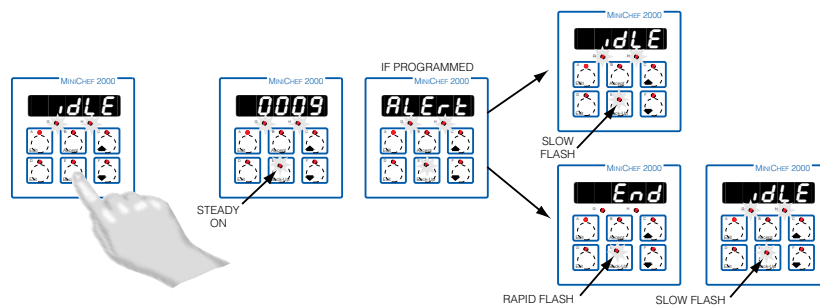

3. Press the Start/Stop key.

The Start/Stop key indicator light will light up. Time will count down on the display.

4. If programmed, as the time counts down, a mid-point alarm will appear on the display.

The alarm messages which varies based on programming will appear for ten seconds.

An audible will sound for five seconds. Time will continue to count down on the display.

5. When the cooking cycle is finished one of the following will happen, depending on the way the controller was programmed at **ETYPE** / **Sound**:

With Sound set to 0: The controller automatically switches to idle. **idle** or current time will appear on the display. The Start/Stop key indicator light will flash slowly. The controller will maintain temperature at the programmed set point.

With Sound set to 1, 2, or 3: **End** will appear on the display and an audible tone will be emitted. The Start/Stop key indicator light will flash rapidly. You can acknowledge and silence the tone by pressing the Start/Stop key or it will automatically time out within 2 seconds for setting 1 or 20 seconds for settings 2 or 3 and then go into idle. The Start/Stop key indicator light will flash slowly. The controller

will maintain temperature at the programmed set point.

With sound set to 4 or 5: **End** will appear on the display and the Start/Stop key indicator light will flash rapidly. You must acknowledge the audible tone by pressing the Start/Stop key. Once acknowledged the audible tone is silenced and the controller goes into idle. The Start/Stop key indicator light will flash slowly. The controller will maintain temperature at the programmed set point.

6. Remove the food from the fryer.
7. To repeat cooking, repeat steps 1 through 6.

Auxiliary Idle Set Points

In some cases you may want to control at some non-cooking temperature such as during cleaning, preheating or to preserve the life of the oil. The controller is equipped with the capability of two auxiliary idle set points: Idle One and Idle Two.

To program either of the set points:

1. Press and hold down the Idle One Temp or Idle Two Temp key.
2. While holding down the key, use the Up-arrow or Down-arrow key to adjust the set point temperature.
3. Release all of the keys.

The idle temperature has been set.

4. Program the other Idle temperature if desired by repeating 1 through 3 using the other Idle Temp key.

To run the fryer at an auxiliary idle set point:

- With the fryer in idle (not running a menu) press either the Idle One Temp or Idle Two Temp key.

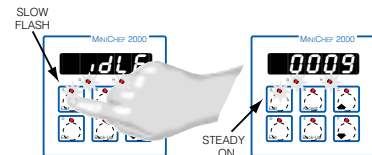

The indicator light over the Idle Temp key will flash slowly.

The fryer will run at the idle set point until you run a menu by pressing the Start/Stop key or you press the other Idle Temp key.

Cancel a Menu

Canceling a menu stops the controller completely. The controller does not maintain set point temperatures or run time. You cancel a menu to run another menu, stop menu operation for any reason, or are preparing to shut off the oven.

- Press the Start/Stop key for 2 seconds. Heat outputs will switch off. The heat output indicator light will switch off. **idLE** or time of day will be on the display.

Restart a Menu

1. If the controller is preheating or running a menu, cancel the menu by pressing and holding the Start/Stop key for 2 seconds. If the controller is in **idLE**, go to 2.
2. Press the Start/Stop key.

Based on its programming, the unit will run the menu in one of the ways described earlier.

Change Menus

1. With the controller in idle, select the menu you want to run by performing the procedure under “Select a Menu” earlier in this section.
2. Press the Start/Stop key.

Based on its programming, the unit will run the menu in one of the ways described earlier.

Temperature Alarms

The controller will alert you to temperature alarm conditions if they occur. If an alarm occurs, take action as determined by your supervisor. See the Appendix in the *Hardware & Software Setup Guide* for a Troubleshooting Chart and a summary of temperature alarms.

Errors

The controller will alert you to errors if they occur. Errors are critical problems that shut down the unit. If an error occurs, an error message will appear on the display. You should switch off the power and call for service.

See the Appendix in the *Hardware & Software Setup Guide* for a Troubleshooting Chart and a summary of errors.

Notes

Application 19

Manual Deepfat Fryer



One Heat Channel

<i>Introduction to Application 19</i>	<i>95</i>
<i>Configuration Mode Quick Reference</i>	<i>97</i>
<i>Step 7 Design a Faceplate Overlay</i>	<i>99</i>
<i>Step 8 Operate the Controller</i>	<i>100</i>

Application 19 allows you to program a menu to control one temperature channel and cooking time for a manual deepfat fryer.

Overview of Key Steps

1. Install the MINICHEF 2000.
2. Wire the controller.
3. Configure the controller.
4. Program the menu.
5. Set the controller security.
6. Set the Real-time Clock.
For instructions on Steps 1, 2, 3, 4, 5 and 6, see the *Hardware & Software Setup Guide*.
7. Design, manufacture and apply faceplate overlay for end-users. (For a suggested design to suit this application, see this section. For overlay dimensions and guidelines, see the *Hardware & Software Setup Guide*.)
8. Operate the controller. (See this application guide.)

Key Functions in Configuration Mode



Key Functions in Operation Mode

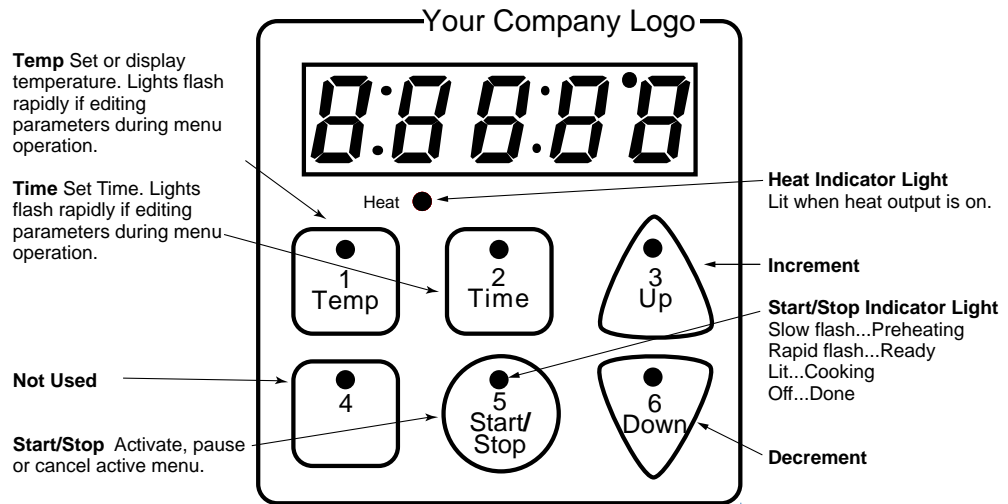

Summary of Input/Output Functions

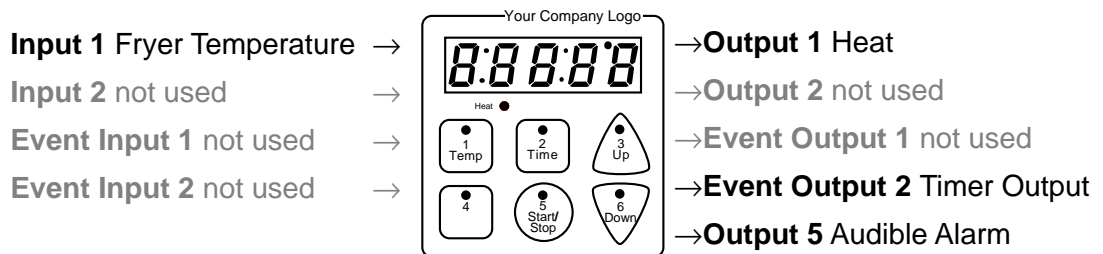

Note: For details, see wiring instructions in the *Hardware & Software Setup Guide*.

Configuration Mode Quick Reference

These are the functions, parameters and values included in the Configuration Mode for this application. You must select Application 19 to access them. For directions, see the *Hardware & Software Setup Guide*. The Appendix of that guide includes an explanation of all parameters and values.

Function	Parameter	Value	Your Settings
EqUPE Equipment-Type	APPL Application Number	1 - 28	19
	A_Loc Application Number Security Lock	Yes, No	
SEtUP Setup	OnOff Oil Melt Cycle	On, Off	
	Out Timer Output	No, Yes	
	C_F Temperature Display Format	°C or °F	
	TIME Time Display Format	MMM:SS, HH:MM, H:MM:SS (H=Hours, M=Minutes, S=Seconds)	
	ChirP Key Chirp	On, Off	
	tc Thermocouple Type	J, K (shown as H), E	
	rtD RTD Curve	DIN, JIS	
	tcOnP WatCurve™ Temperature Compensation	On, Off	
	OFFSEt Temperature Offset, Channel 1	-99 to 99°F (-55 to 55°C)	
	tr Lo Temperature Range Low	0°F (-18°C) for RTD inputs 32°F (0°C) for tc inputs to tr Hi	
	tr Hi Temperature Range High	tr Lo to 1200°F (649°C)	
	PREADY Preheat Ready Feature	Yes, No	
	rbRNd Ready Band	1 to 1200°F (649°C)	
	CLoc Real Time Clock Display	Yes, No	
	PLOSS Power Loss Menu Resume	Yes, No	
tHErL Thermal	AL Alarms for channel 1	None, Dev, Proc, Both	
	AL P1 Absolute Process Alarm 1	100 to 1200°F (38 to 649°C)	
	ALdL1 Low Deviation Alarm 1	-999 to 0°F (-555 to 0°C)	
	ALdH1 High Deviation Alarm 1	0 to 999°F (0 to 555°C)	
	tYPE Temperature Control Type	PID, On-Off	
	HYSL1 Hysteresis 1	1 to 99°F (1 to 55°C)	
	PId U PID Units	SI, US	
	tUnE1 Auto-tuning 1	on, OFF	
	PrOP1 Proportional Band 1	1 to 999°F (1 to 555°C)	
	rSEt1 Reset (integral) Gain 1	0.00 to 9.99 repeats/minute	
dIAG WatHelp Diagnostics	int1 Integral Gain 1	0.00 to 99.99 minutes/repeat	
	rAtE1 Rate (derivative) Gain 1	0.00 to 9.99 minutes	
	dER1 Derivative Gain 1	0.00 to 9.99 minutes	
	CYCL1 PID Cycle Time 1	1 to 60 seconds	
	Used for equipment troubleshooting and testing. Not used when programming. See the <i>Hardware & Software Setup Guide</i> .		

Auto-tuning Note:

Before auto-tuning Application 19, **tENP 1** in the operations menu must first be set to a value that is typical of your application. (See *Hardware & Software Setup Guide* for information on programming menus.) Then set **tHERt / tUnE 1** to **on**. After you accept **on**, by pressing “Enter,” the controller will display **tUnE** while auto-tuning is taking place.

The controller will cancel the auto-tuning process if it cannot be completed in 80 minutes. You can cancel the auto-tuning process at any time by pressing either key C or key D and accepting **OFF**, by pressing “Enter,” when it appears.

Step 7 Design a Faceplate Overlay

To complete the installation, you must apply a graphic membrane to the front panel of the controller. The following artwork will help you design and create a membrane for this application. For more dimensions and guidelines, see the *Hardware & Software Setup Guide*.

Suggested End-user Overlay:

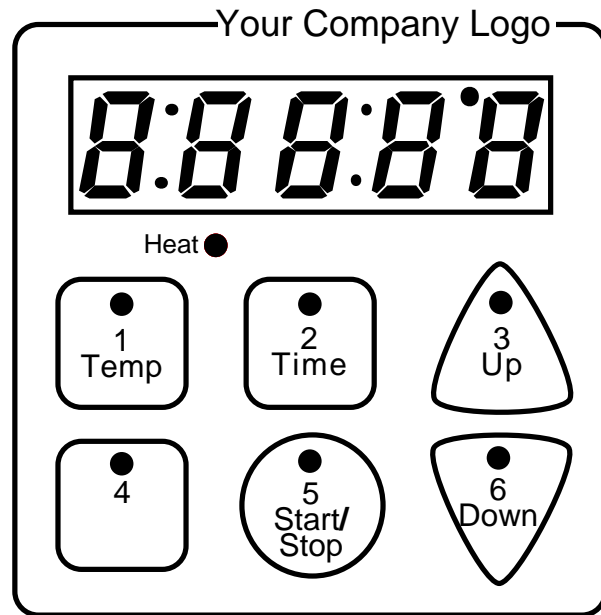

This Prototyping and Training Membrane Overlay will help you with the configuration and programming steps. To order it, see the Ordering Information at the back of this guide.



Step 8 Operate the Controller

Summary of Key Functions in Operation Mode

Key	Function
A	Temp
B	Time
C	Increment
D	Not Used
E	Start/Stop
F	Decrement

Startup

Apply power to the fryer and add cooking oil if necessary.

Set the Menu

Set the cooking temperature.

1. Press the Temp key **TEMP** and then the cooking temperature value will appear on the display.
2. Press the Up-arrow or Down-arrow key until the value you want appears on the display.
3. Press the Temp key again.

The cooking temperature has been set.

idLE will appear on the display.

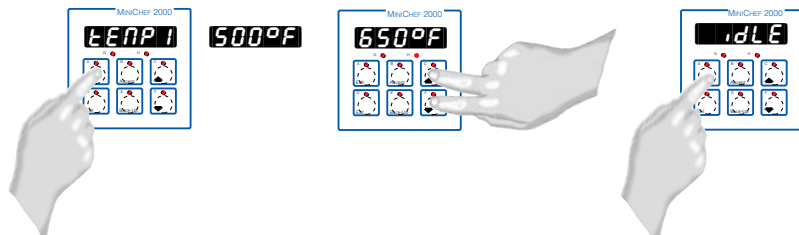

Set the cooking time.

1. Press the Time key **TIME** and then the cooking time value will appear on the display.
2. Press the Up-arrow or Down-arrow key until the value you want appears on the display.
3. Press the Time key again.

The cooking time has been set.

idLE will appear on the display.

Five Second Timeout

When using the up or down keys to change a value, if you do not press any key for 5 seconds, the controller will automatically be set to the last value on the display and return to **idle**.

Initial Preheat

At power-up, the unit will preheat to the temperature value set in the Configuration Mode **TYPE / PREHEAT**. The display will show **PRE- HEAT** followed by oil temperature as the oil heats.



When the unit reaches initial preheat temperature, **READY** will flash once on the display and an audible tone will sound for 2 seconds. Then **idle** will appear on the display. If Real Time Clock option is installed and **SETUP / CLocK** is set to **YES**, the time of day will appear on the display.

Preheat

If in the Configuration Mode **SETUP / READY** has been set to yes, the controller will detect temperatures and preheat to operating temperature (above relative set point minus the ready band) as required.

- Activate the manual menu by pressing the Start/Stop key.

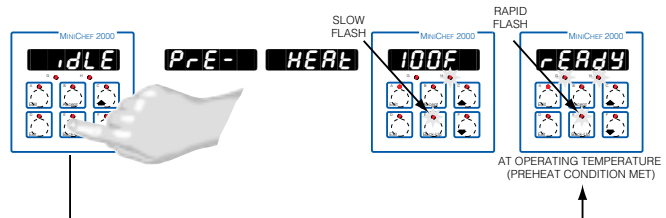

If the fryer is not at operating temperature, it will preheat. Meanwhile:

The word **PRE- HEAT** will appear on the display for a few moments. The Start/Stop key indicator light will flash slowly. The temperature of Channel 1 will be displayed until the operating temperature is reached.

The heat output indicator light - G, just below the display- will light up whenever the controller is calling for heat.

When the fryer is at operating temperature (above relative set point minus the ready band) **READY** will appear on the display and the Start/Stop key indicator light will flash rapidly. You are now ready to cook with the active menu.

If the fryer is at operating temperature, the display goes directly to **READY** without indicating preheat or temperature.

The Melt Cycle

To avoid burning congealed oil (shortening), a slow heating action may be necessary. If this is desired, be sure that in the Configuration Mode **EEYPE** / **PREHEAT** has been set to **on**. Then, when the oil temperature is below 212 °F the heat output will be limited to 10% of full power. This reduces the chance of burning congealed oil while it is heating.

Run a Menu (with preheat feature)

This procedure describes how to run an active menu when the preheat feature is active — in other words, when the **READY** parameter in the **SETUP** function of the Configuration Mode is set to **YES**.

1. Set the menu as shown earlier.
2. With **idle** or time of day on the display, press the Start/Stop key.

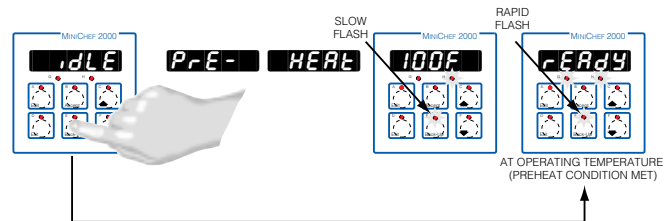

If the menu's preheat condition has not been met, the fryer will preheat until **READY** appears on the display. If the fryer is at operating temperature **READY** will immediately appear on the display.

3. With **READY** on the display, place the food in the basket and press the Start/Stop key (indicated by the flashing red light). The Start/Stop indicator light will light up and time will count down on the display.

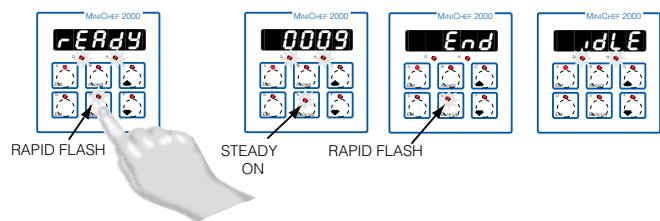

4. When the cooking cycle is finished **End** will appear on the display and an audible tone will be emitted. The menu key indicator will flash rapidly. You can acknowledge and silence the tone by pressing the active menu key or it will time out in 2 seconds and go into idle.
5. Remove the food from the fryer. The controller will continue to regulate to the last set point.
6. To repeat cooking, repeat steps 1 through 6.

Run a Menu (without preheat feature)

This procedure describes how to run a menu when the preheat function is inactive —

that is, when the **rEAdy** parameter in the **SEtUP** function of the Configuration Mode is set to **no** — and initial preheat power-up has been completed.

1. Set the menu as shown earlier.
2. With **idLE** or time of day on the display, press the Start/Stop key

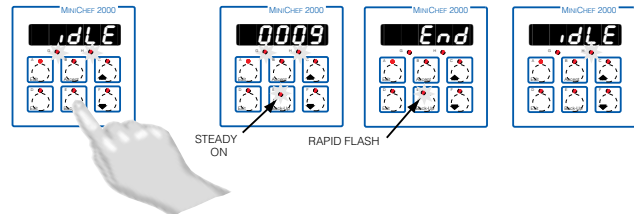

The Start/Stop will light up and then time will count down on the display.:

5. When the cooking cycle is finished **End** will appear on the display and an audible tone will be emitted. The menu key indicator light will flash rapidly. You can acknowledge and silence the tone by pressing the active menu key or it will time out in 1 to 20 seconds and go into idle.
6. Remove the food from the fryer. The controller will continue to regulate at the last set point. The menu indicator light will flash slowly.
7. To repeat cooking, repeat steps 1 through 5.

Adjust a Menu While Cooking

You can adjust the temperature and time settings during the cooking and hold sequences by performing the actions shown under “Set the Menu” earlier in this section.

Changes can be made to temperature and time only during the portion of the cooking sequence in which they are active. For example: a change to the cooking temperature **TEMP 1** can be made only when the cooking temperature is being run during the cooking sequence.

Temperature changes made while cooking are saved and become part of the permanent menu. Time changes are not saved and do not become part of the permanent menu.

Cancel a Menu

Canceling the menu stops controller operation completely. The controller does not maintain set point temperatures or run time. Users may cancel the menu in order to run another one, to stop menu operation for any reason, or when preparing to shut off the fryer.

- Press the Start/Stop key for 2 seconds.

Heat outputs will switch off. Heat output indicator lights will switch off. The display presents **idLE** or the time of day will appear on the display.

Change or Restart Menus

1. Set a menu as shown earlier.
2. Press the Start/Stop key.

Timer Output

If **EETYPE** / **EOUT** in the Configuration Mode is set to **YES**, when time is counting down Event Output 2 is on. It is off during **PAUSE**, **IDLE** or **HOLD**.

Temperature Alarms

The controller will alert you to temperature alarm conditions if they occur. If an alarm occurs, take action as determined by your supervisor. See the Appendix in the *Hardware & Software Setup Guide* for a Troubleshooting Chart and a summary of temperature alarms.

Errors

The controller will alert you to errors if they occur. Errors are critical problems that shut down the unit. If an error occurs, an error message will appear on the display. You should switch off the power and call for service.

See the Appendix in the *Hardware & Software Setup Guide* for a Troubleshooting Chart and a summary of errors.

Specifications (1032)

Control Mode

- Single and dual heat channels, PID or on/off.¹
- Microprocessor-based, programmable, reverse-acting control outputs.
- User-selectable embedded application software defines operation of display, keys, inputs, outputs, timing action.
- One-step auto-tuning, WatHelp diagnostics, WatCurve temperature compensation.

Agency

- CE approved:
 - 89/336/EEC Electromagnetic Compatibility Directive
 - EN 50081-1: Emissions
 - EN 50082-1: Immunity
 - 73/23/EEC Low-Voltage Directive
 - EN 60730-1 and EN 60730-2-9: Safety
- NSF Listed, Criteria 2.⁵
- AGA: UL tested to AGA standard Z21.23, UL File #E43684 .
- UL and C-UL recognized, UL 197, 873, 991 and CSA standard C22.2-24, File # E43684.

Operator Interface

- Membrane overlay, contamination and water resistant, (supplied by customer).
- LED display, 5-digit, 0.56 in high, red.
- Displays times, temperatures, user prompts and diagnostic codes.
- User-selectable time and temperature display formats.
- Temperature display formats—°F or °C.
- Time display formats—H:MM:SS, HH:MM, or MMM:SS.
- 8 discrete indicator LEDs, red.
- 6 tactile feedback keys.
- Menu-driven operation and manual modes available.
- WatHelp diagnostics.
- Real-time clock option displays time of day.

Accuracy

- Calibration accuracy and sensor conformity²: $\pm 2.0^\circ\text{F}$ for Type J thermocouple and RTD, $\pm 0.35\%$ of span for Type K and E thermocouples, ± 1 LSD, $77^\circ\text{F} \pm 5^\circ\text{F}$ ambient and rated line voltage of $\pm 10\%$.
- Accuracy span: 1000°F (540°C) minimum.
- Temperature stability: $\pm 0.15^\circ\text{F}/^\circ\text{F}$ ($0.15^\circ\text{C}/^\circ\text{C}$) change in ambient typical.

Sensors/Inputs

- Contact inputs, TTL compatible with internal pull-up resistor, two available.
- Thermocouple,³ software selectable Type J, K or E, 32 to 1200°F. (Dual-channel applications require at least one ungrounded thermocouple).
- RTD,³ 2- or 3-wire, platinum, 100, 500, 1000Ω, at 0°C, software selectable DIN or JIS curves, 0 to 1200°F (3-wire will function as 2-wire).
- Input A/D resolution: 15 bit.

Output Options

- Solid-state relay, 0.4A, with or without contact suppression.
- Switched dc signal, 4.5V to 5.25V, 30mA maximum output, minimum load resistance > 150Ω, non-isolated.

Audible Output Options

- Switched dc signal, 4.5V to 5.25V, 30mA maximum output, minimum load resistance > 150Ω, non-isolated.
- Internal audible alarm, 75dB at 10 cm.

Connectors

- Sensor Input Terminal Strip⁴: RIACON, 6-position, quick-connect.
- Power Supply & Input/Output Terminal⁴: AMP, 15-position, quick-connect.

Power/Line Voltage

- 20.4 to 26.4V~ (ac), 47 to 63Hz.
- 15VA maximum.
- For CE applications, input power must be limited to 15W external to the control.
- Program retention upon power failure via non-volatile memory.
- Battery/real-time clock option: 6-year lithium battery, provides power backup upon power failure, operation resumption after power recovery, ability to display time of day.

Operating Environment

- 32 to 176°F (0 to 80°C), 0 to 90% RH, non-condensing.

Storage Temperature

- -40 to 176°F (-40 to 80°C).

Mechanical

- Case: polycarbonate Lexan with adjustable mounting collar (vertical or horizontal orientation), designed for mounting on 16-, 18-, 20- and 22-gauge panels.
- Internal panel mounting requires a specified panel cutout and four #6-32 studs or equivalent.
- Overall width x height x depth: horizontal - 4.13 in x 3.25 in x 2.00 in; vertical - 3.25 in x 4.13 in x 2.00 in (Assumes mating connectors are attached. Does not include wire bundle space requirements.).
- Vibration: 2g, 10 to 150Hz, applied in any one of three axes.
- Weight: 6.50oz maximum.

Program Storage

- All non-embedded user and factory programs are stored in non-volatile memory. Can be changed by reprogramming.

Sample/Update Rates

- 1 input: 4Hz.
- 2 inputs: 4Hz.
- PID: 1Hz.
- Control outputs: 100Hz.
- Display: 10Hz.

¹ The MINICHEF 2000 controller is to be used in systems with an external high temperature limiting device.

² Thermocouple lead resistance of 200Ω causes < 1°C error. RTD, 22 gauge wire will not contribute more than 0.086°F error/ft.

³ Dual channel applications require either two thermocouple sensors or two identical RTD sensor types.

⁴ For mating connector information, see Ordering Information Accessory section.

⁵ Certified for thermometer accuracy (oven and hot food holding applications from 32°F to 60°F) when used with RTD or type J thermocouple probes.

Ordering Information

(1033)

MINICHEF™ 2000

Cooking controller with numerous food equipment application software sets, single and dual channel on/off or PID temperature regulation, timer and machine-function control, microprocessor-based, programmable, auto-tuning, WatCurve™, WatHelp diagnostics, 24V~ (ac) power input, agency approved, flush mounted (membrane faceplate supplied by customer).

Inputs

- 1 = Dual thermocouple, Type J, K or E
- 2 = Dual RTD, platinum, 100Ω, curve selectable
- 3 = Dual RTD, platinum, 500Ω, curve selectable
- 4 = Dual RTD, platinum, 1000Ω, curve selectable

Note: All models include two event inputs, switched dc logic signal, non-isolated.

Output Number 1

- 1 = Switched dc, 5V nominal, 30mA, non-isolated
- 2 = Solid-state relay, Form A, 0.4A, without RC suppression
- 3 = Solid-state relay, Form A, 0.4A, with RC suppression

Output Number 2

- 1 = Switched dc, 5V nominal, 30mA, non-isolated
- 2 = Solid-state relay, Form A, 0.4A, without RC suppression
- 3 = Solid-state relay, Form A, 0.4A, with RC suppression

Event Outputs 1 and 2

- 1 = 2 event outputs, switched dc, 5V nominal, 30mA, non-isolated

Battery and Real-time Clock

- 0 = None
- 1 = Includes battery and real-time clock

Audible Alarm

- 0 = Alarm signal available at connector, switched dc, 5V nominal, 30mA, non-isolated
- 1 = Internal alarm included

Software

- AA = Standard Food Equipment Application Software Set
- XX = Custom Set-up parameters or Made-To-Order custom software. Consult your local Watlow Sales Engineer. Code number assigned by factory.

F 2 H A - 1 - A A

Ordering Information: Part Numbers & Accessories

MINICHEF 2000 Accessories

0836-0442-0000	Sensor Input Mating Connector, (RIACON #31007106), 6-position, quick-connect terminal, screw connection for 28-14 AWG wires, tighten to 7 in/lb
A001-0298-0000	Power Supply and I/O Mating Connector Kit. Includes: – 1 AMP #1-640523-0, 15-position, quick-connect terminal – 15 AMP #641300-1 crimp pins
0238-0679-0000	Prototyping & Training Membrane Overlay, adhesive-backed, 4.75 in x 4.75 in
0830-0479-0000	Prototyping EPROM Extraction Tool, AMP #821980-1
A001-0249-0001	120V~ to 24V~ (ac), stepdown transformer, class 2, quick-connect terminals included
A001-0249-0002	208/240V~ to 24V~ (ac), step-down transformer, class 2, quick-connect terminals included

MINICHEF 2000 Documentation

WMC2-XUGN-0000	The Complete MINICHEF 2000 User Guide
WMC2-XADN-0000	The Complete MINICHEF 2000 User Guide on CD
WMC2-XTDN-0000	MINICHEF 2000 Tutorial Disk
WMC2-XSGN-0000	Hardware & Software Setup Guide
WMC2-XAGN-0001	Cook-&-Hold Oven Application Guide
WMC2-XAGN-0002	Convection Oven Application Guide
WMC2-XAGN-0003	Deepfat Fryer Application Guide
WMC2-XAGN-0004	Griddle Application Guide
WMC2-XAGN-0005	Timer Application Guide
WMC2-XAGN-0006	Shelf-Timer Application Guide
WMC2-XAGN-0007	Rotisserie Oven Application Guide

Recommended Sources of Supply for Miscellaneous Items

DURA-TECH, Inc. LaCrosse, WI (608) 781-2570	• <i>Custom Membrane Faceplates</i>
AMP, Inc. Harrisburg, PA 1-800-522-6752	• <i>Prototyping EPROM Extraction Tool</i> Part No. 821980-1 • <i>Pin Crimping Hand Tools</i> Part No. 90325-1 or 58514-1 • <i>Pin Extraction Hand Tool</i> Part No. 455822-2
RIA Electronic, Inc. Eatontown, NJ (908) 389-1300	• <i>RIACON Connectors</i>

Watlow Controls

Watlow Controls is a division of Watlow Electric Mfg. Co., St. Louis, Missouri, a manufacturer of industrial electric heating products since 1922. Watlow begins with a full set of specifications and completes an industrial product that is manufactured totally in-house, in the U.S.A. Watlow products include electric heaters, sensors, controls and switching devices. The Winona operation has been designing solid state electronic control devices since 1962, and has earned the reputation as an excellent supplier to original equipment manufacturers. These OEMs depend upon Watlow Controls to provide compatibly engineered controls that they can incorporate into their products with confidence. Watlow Controls resides in a 100,000-square-foot marketing, engineering and manufacturing facility in Winona, Minnesota.

Technical Assistance

If you encounter a problem with your Watlow controller, refer to the Troubleshooting Chart in this guide. Also review all of your configuration information for each step of the setup to verify that your selections are consistent with your applications.

If the problem persists after checking all the steps, you can get technical assistance by calling Watlow Controls at (507) 454-5300, between 7 a.m. and 5 p.m. CST, and asking for an applications engineer. When you call have the following information on hand: the controller's part number, date code, serial number, software revision number, and application number. Much of this information is available on the controller case. All of this information is also available via the MINICHEF 2000 main display by accessing the WatHelp Diagnostics Function under **d.1.19** in the Configuration Mode.

We Value Your Feedback

Your comments and suggestions on this manual are welcome. Please send them to, Technical Writer, Watlow Controls, 1241 Bundy Blvd., P.O. Box 5580, Winona, MN 55987-5580 or call (507) 454-5300 or fax (507) 452-4507.

Contact

- Phone: (507) 454-5300.
- Fax: (507) 452-4507.
- For technical support, ask for an Applications Engineer.
- To place an order, ask for Customer Service.
- To discuss a custom option, ask for the MINICHEF 2000 Product Manager.

Warranty

The MINICHEF 2000 is warranted to be free of defects in material and workmanship for 36 months after delivery to the first purchaser for use, providing that the unit has not been misapplied. Since Watlow has no control over its use, or misuse, we cannot guarantee against failure. Watlow's obligations hereunder, at Watlow's option, are limited to replacement or refund of purchase price of a unit which upon examination proves to be defective within the warranty period. This warranty does not apply to damage resulting from transportation, alteration, misuse, or abuse.

Returns

- Call or fax Customer Service for a Return Material Authorization (RMA) number before returning a control.
- Put the RMA number on the shipping label, and also on a description of the problem.
- 20% of net price restocking charge applies to all standard units returned to stock.

Note: All documentation of the MINICHEF 2000 is subject to change without notice.

