

# Watlow IR Junior

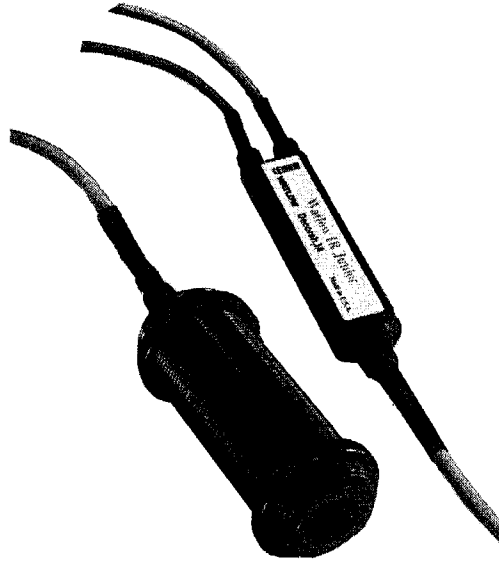

## Non-Contact Infrared Temperature Sensor

User's Manual



# WATLOW

Watlow System Integrators, Freeport Industrial Park,  
Box 169, Decorah, IA 52101  
Phone: 319/382-8446, Fax: 319-382-2418

DCJR-MA40-9509  
March, 1995  
Supersedes: DCJR-MA30-9440

Made in the U.S.A.

 Printed on Recycled Paper

## **If You Don't Read Anything Else... Read This Page**

Fatal damage to the sensor or the devices connected to the sensor can occur if not installed properly. If you are unsure of any sensor placement or wiring procedures, please refer to the appropriate section in this manual, or contact your Watlow representative or contact Watlow Infrared for technical assistance.

Before installing the Watlow IR Junior infrared sensor, the following items must be considered.

- Does the material being measured have a high emissivity? *See Page 11.*
- Are you sure the spot size of the sensor will completely fill the targeted object? *See Page 14.*
- What ambient temperature will the sensor be exposed to? *See Page 15.*
- Are the input power requirements met? *See Page 17.*
- Is the polarity of the input power correct? *See Page 17.*
- Is the device connected to the sensor compatible with the output signal of the sensor? *See Page 17.*
- Is the polarity correct for the output signal? *See Page 17.*

**If you are unsure of any of these questions, do not assume an answer. Refer to the page listed in this manual.**

## Warranty

The Watlow IR Junior is warranted to be free of defects in material and workmanship for 18 months after delivery to the first purchaser for use, providing that the unit has not been misapplied.

Since Watlow has no control over the use, and sometimes misuse of the sensor, we cannot guarantee against failure. Watlow's obligations hereunder, at Watlow's option, are limited to replacement, repair or refund of purchase price, and parts which upon examination prove to be defective within the warranty period specified. This warranty does not apply to damage resulting from transportation, alteration, misuse or abuse.

## Technical Assistance

If you encounter a problem with your Watlow Infrared sensor, review the user's manual, wiring and installation to verify that your sensor is setup correctly. If the problem persists after checking the above, you can get technical assistance by calling (319) 382-8446.

An Application Engineer will discuss your application with you. Please have the following information available when calling:

Complete model number  
All configuration information

Serial number  
User's Manual

## Table of Contents

Warranty .....	3
Technical Assistance .....	3
General Description .....	5
Specifications .....	6
Dimensions.....	9
Sensor Installation .....	11
Material Type Measured .....	11
Good Materials .....	11
Transmissive Materials .....	12
Reflective Materials .....	13
Improving the Emissivity of a Surface .....	13
Sensor Placement .....	14
Spot Size/Field of View .....	14
Angle of Sensor to Product .....	15
Ambient Temperature .....	15
Atmospheric Conditions .....	16
Mounting the Sensor .....	16
Sensor Wiring .....	17
Input Power .....	17
Output Signal .....	17
Power Pack Installation .....	18
Operation .....	22
Out of Limits Parameters .....	24
Troubleshooting Guide .....	25
Custom Parameters for Sensors .....	26
Maintenance .....	27
Returns .....	28
Ordering Information .....	29

**Senso**

**Output**

- 1 = Typ
- 2 = Typ
- 3 = 0-5\
- 4 = 0-10
- 5 = 4-20
- 6 = 0-20

---

**Sensc**

**Output**

- 1 = Typ
- 2 = Typ
- 3 = 0-5\
- 4 = 0-10
- 5 = 4-20
- 6 = 0-20

---

**Sensc**

**Output**

- 1 = Typ
- 2 = Typ
- 3 = 0-5\
- 4 = 0-10
- 5 = 4-20
- 6 = 0-20

**Access**

**Mountin**

## General Description

The Watlow IR Junior is a non-contact infrared temperature sensor that provides thermocouple, linear current or voltage signal output. The sensor is well suited for a wide range of applications.

The Watlow IR Junior is designed to meet NEMA 4X water and corrosion resistance. This permits the sensor to be used in applications where the infrared sensor will be exposed to a wash down environment for cleaning purposes.

The sensor's compact size allows for flexibility in applications where space is a problem. The sensor does not require any other support electronics. Applying 18 to 28VDC to the input power connections is all that is required for operation.

For dirty environments an air purge collar can be ordered for the sensor to help protect the lens from settling debris. In applications having space limitations, a right angle mirror can be ordered.

For literature regarding technical information and support products, contact your Watlow representative for a copy of:

*What you should know about applying a low temperature infrared sensor*

## Specifications

### Temperature Sensing Range

- 32 to 1000°F (0 to 538°C)

### Field of View / Spot size

<u>Distance</u>	<u>Spot size</u>
1.0" (25 mm)	0.6" (15 mm)
3.0" (76 mm)	0.8" (19 mm)
6.0" (152 mm)	1.0" (25 mm)
9.0" (229 mm)	1.4" (36 mm)
18.0" (457 mm)	2.5" (64 mm)
36.0" (914 mm)	4.5" (114 mm)

### Wavelength Response Band

- 8 to 14 microns

### Accuracy

- 0.75% of span at 75°F (24°C) ambient, E = 1.00

### Repeatability

- 0.4% of span

### Operating Environment

- 32 to 175°F (0 to 80°C)

### Output signal

- Type "J" thermocouple into a minimum 10K load, non-isolated
- Type "K" thermocouple into a minimum 10K load, non-isolated
- 4-20mA into a maximum 600 load, non-isolated
- 0-20mA into a maximum 600 load, non-isolated
- 0-5VDC into a minimum 10K load, non-isolated
- 0-10VDC into a minimum 10K load, non-isolated

### Power

- +18 to 28VDC

### Emissivity

- Fixed at 0.90
- 50mA maximum

### Dimensions (Sensor only)

- Length 3.50" (89 mm)
- Diameter 1.25" (32 mm)
- Threads 18 UN-2A

Clea  
Care  
foreign

To cl

1. L

2. G  
th

3. R

4. A



desti

Watk  
ing C  
lisher  
busir  
a full  
prod  
Prod  
heati  
powe

Watk

## Specifications (continued)

### Agency Approvals

- UL and CSA pending
- Patent pending

### Environmental Rating

- NEMA 4X, water and corrosion resistant

### Weight

- 5.1 oz. (145 g)

### Response Time

- 700 milliseconds to respond to 95% of target (3 time constants)
- 350 milliseconds to respond to 80% of target (2 time constants)
- 233 milliseconds to respond to 66% of target (1 time constants)

### Connections

#### Input

- Input power 22 gauge

#### Output

- Thermocouple 20 gauge wire
- Voltage output 22 gauge with drain
- Current output 22 gauge with drain

### Cable Length

- 3.0' (0.914 m)

## IR Junior with Air Purge Collar or Right Angle Mirror

### Required Air Pressure

- 5 P.S.I. (34.5 kPa)

### Air Quality

- Filtered to 10 microns

### Air Fitting Connection

- Accepts 0.125in (3mm) diameter hose

### Input Voltage

## Watlow IR Power Pack Specifications

- Factory selectable
- 100VAC,  $\pm 10\%$ , 50/60 Hz
- 120VAC,  $\pm 10\%$ , 50/60 Hz
- 230VAC,  $\pm 10\%$ , 50/60 Hz
- 200VAC,  $\pm 10\%$ , 50/60 Hz

### Output Voltage

- + 24VDC, unregulated

### Watlow IR Junior Sensor Connections

- Factory selectable
- Up to four sensors

### Operating Environment

- 32 to 140°F (0 to 60°C)
- 0 to 90% RH, non-condensing

### Mounting

- DIN rail, DIN EN 50022, 35 mm X 7.5 mm

### Terminals

- Captive screw, cage clamp connection. 0.155" (4 mm) maximum diameter screwdriver blade. 22-12 maximum wire gauge

### Weight

- 0.88 lb (400 g)

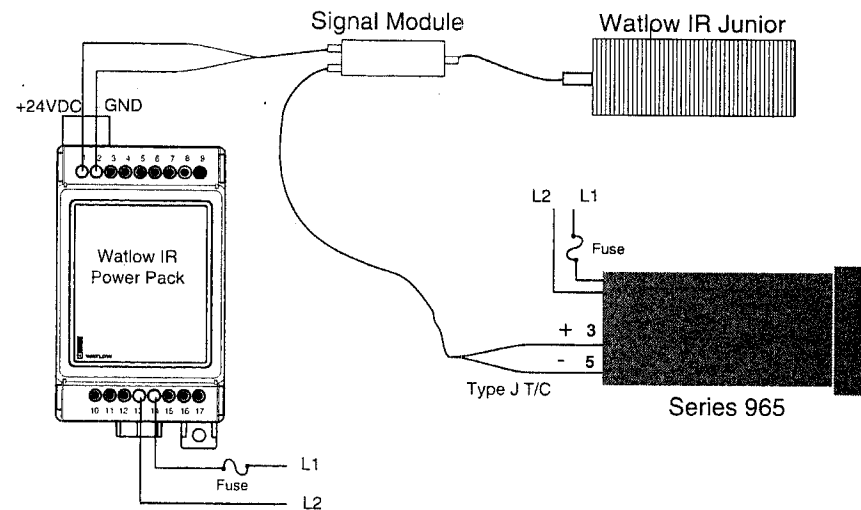

**Figure 1 - System Example**

Sympl

No outp

Sensor  
is too h

Sensor  
is too l

Not  
properly  
It shoul



## Dimensions

Thread size:  
18 UN-2A

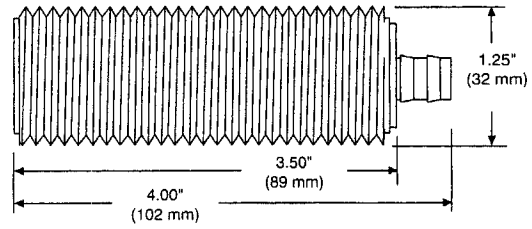

**Figure 2 - Sensor with No Attachments**

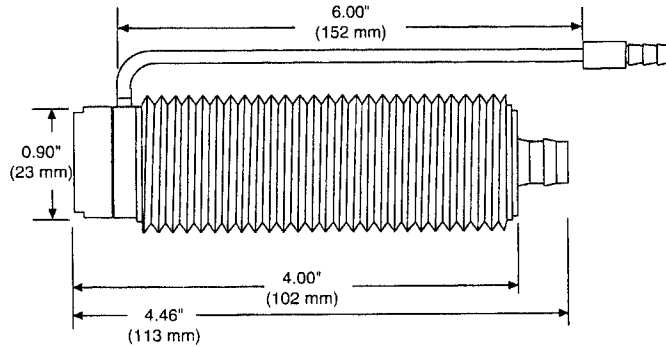
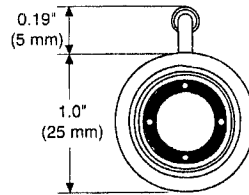

**Figure 3 - Sensor with Air Purge Collar Attachment**

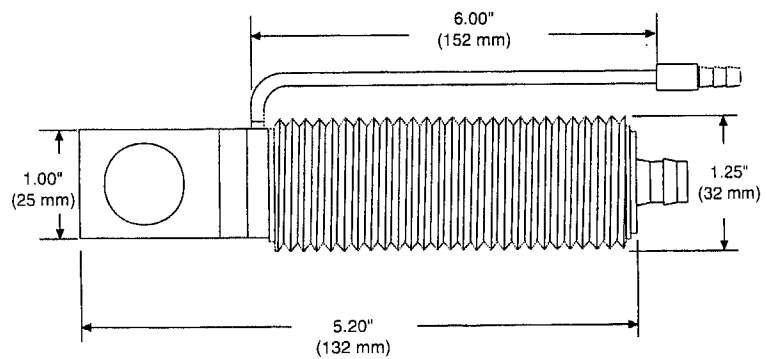

**Figure 4 - Sensor with Right Angle Mirror Attachment**

on.  
out

20mA

0mA

0mA

0mA

0mA

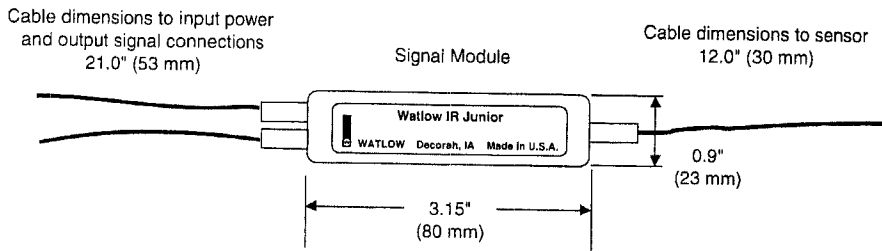

**Figure 5 - Signal Module and Cable Dimensions**

If the e  
approx

↑ The  
rea

↓ The  
rea

The dif  
function  
racy in  
properly  
setting

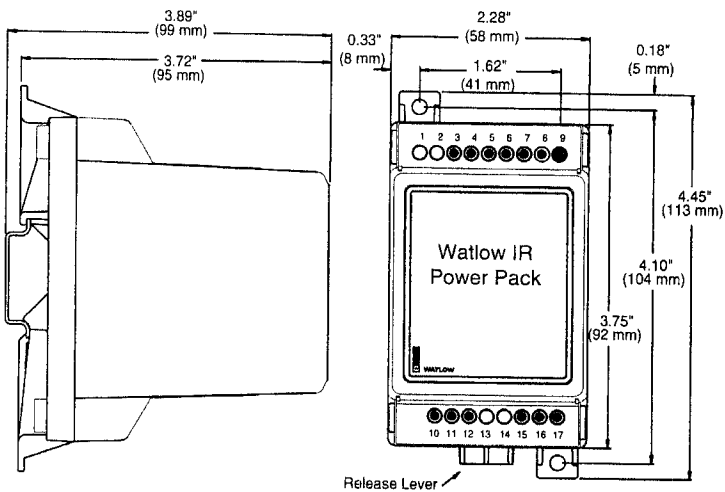

**Figure 6 - Power Pack Dimensions**

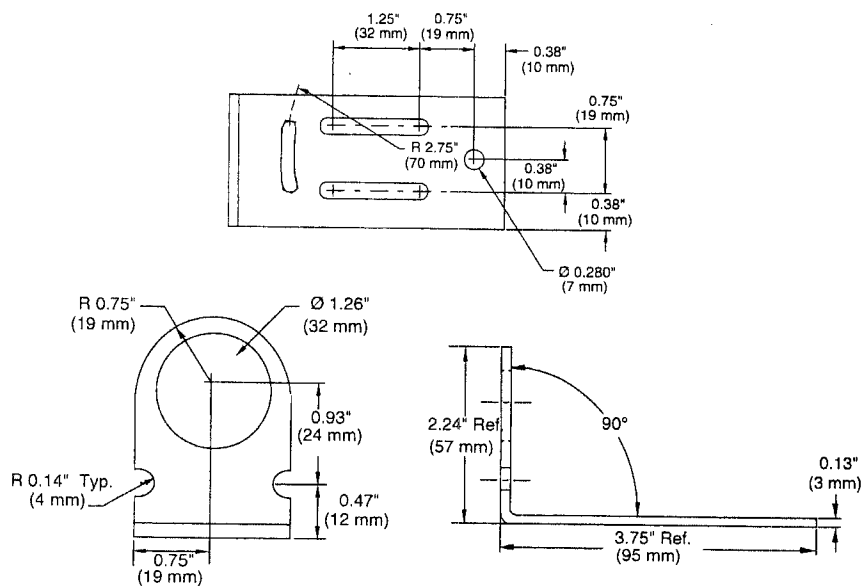

**Figure 7 - Mounting Bracket**

## Sensor Installation

### Preparation

 Before beginning any installation, review the user's manual taking into consideration sensor location, wiring, and noise. Improper installation may cause inaccurate temperature reading due to background radiation, contamination or noisy environments.

### Material Type Measured

#### Good Materials

The sensor should be used to measure materials that have a high emissivity. The surface condition and the type of material have an affect on the emissivity. Materials such as rubber, textiles, paper, thick plastic (greater than 20 mils), painted surfaces, glass and wood are examples of materials with a high emissivity.

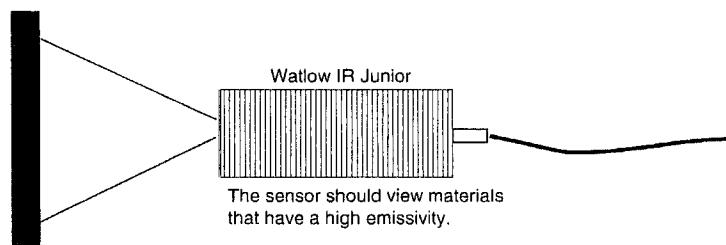

Figure 8 - Measuring High Emissivity Materials

1.00
1
9
16
24
31
39
47
55
63

sivity

Manual

User's Manual

Watlow IR Junior 11

**Note:** The sensor can measure materials that are transparent to visible light (materials that we can see through), assuming that the material is not too thin (less than 10 mils thick). Materials such as plate glass and clear acrylic sheets have a very high emissivity and are excellent infrared sensor applications for the Watlow IR Junior.

## Transmissive Materials

Thin film plastics materials (less than 10 mils thick) may not be practical to measure with the Watlow IR Junior. These materials are highly transmissive, and the sensor will view directly through the material, measuring the temperature of objects behind.

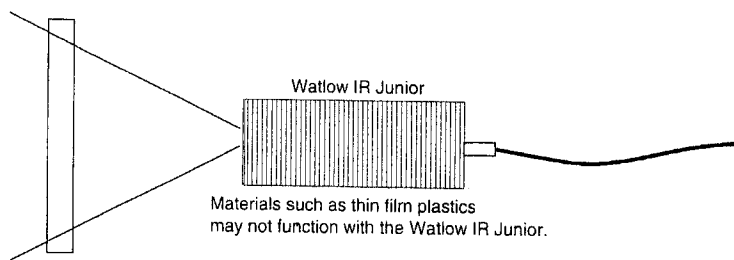

**Figure 9 - Thin Film Plastics May Be Transmissive**

**Note:** Applications involving thin film or transmissive materials can be accomplished by using an infrared sensor with a different spectral response. For more information, contact your Watlow representative.

use  
ng and

ric

eck  
er

## Reflective Materials

Materials that are polished may not be practical to measure with the Watlow IR Junior. Some of these materials include polished stainless steel, copper, brass and other polished metals. If a polished stainless steel object has been painted or is covered in oil, the sensor will detect the painted or oiled surface and provides an accurate measurement.

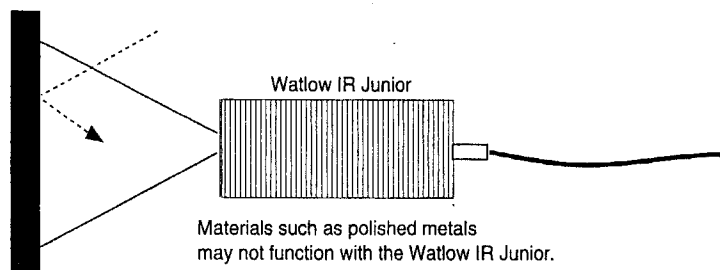

Figure 10 - Polished Materials May Be Reflective

**Note:** Applications involving polished metals or reflective materials can be accomplished by using an infrared sensor with a different spectral response. For more information, contact your Watlow representative.

## Improving the Emissivity of a Surface

The surface of an object with a low emissivity can be improved by:

- Sandblasting
- Painting
- Oxidizing
- Anodizing
- Coating with teflon or plastic

## Spot Size

Before installing, placement of the sensor must first be considered. It is important that the sensor's spot size completely fill the target. The spot size of the infrared sensor is the area measured by the sensor at a given distance from the object. Figure 11 shows the spot size for the Watlow IR Junior.

For example, if the sensor was mounted 18.0" (457 mm) from the targeted object, the sensor will measure an area of 2.5" (64 mm).

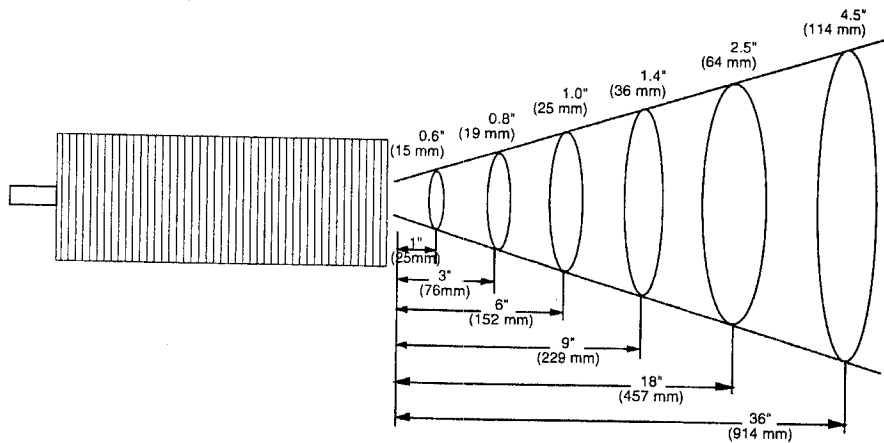
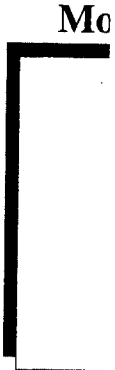

Figure 11 - Watlow IR Junior Spot Size

To maximize accuracy and reduce error due to background radiation, it is recommended that the targeted object be 1.5 times larger than the spot size.

For example, if the sensor is to be placed 6.0" (152 mm) from the targeted object, the target should be at least 1.50" (38 mm), [1.5 times 1.0" (25 mm)].



Figure

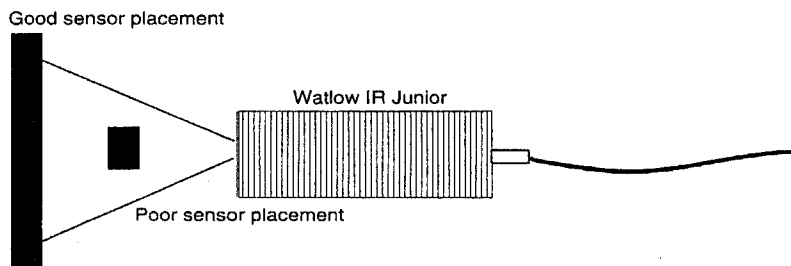

**Figure 12 - Proper Sensor Placement**

### **Angle of Sensor to Product**

To reduce any errors due to reflections of the target surface, it is recommended that the Watlow IR Junior be placed perpendicular to the target. When this is not possible, it is recommended that the sensor be mounted more than 45° from perpendicular to the target surface.

**Note:** The Watlow IR Junior can be ordered with a right angle mirror attachment. The right angle mirror attachment can be used in applications where space is limited.

### **Ambient Temperature**

The Watlow IR Junior is designed to operate in an ambient temperature between 32 to 175°F (0 to 80°C). Reposition the sensor if the sensor will be exposed to temperatures higher than these limits.

## Atmospheric Conditions

It is important that the lens of the Watlow IR Junior be clean of any foreign materials. The sensor should be located in an environment that is fairly clean and free of smoke, dust and fumes. Mount the sensor looking down at an object rather than up, to prevent damage to the lens from falling debris.



**Note: The Watlow IR Junior can be ordered with an air purge collar. The air purge collar blows air in front of the lens to protect it from smoke, dust, fumes and other contaminants settling on the lens.**

## Mounting the Sensor

Once the optimum location for the Watlow IR Junior has been determined, the sensor can easily be mounted with the supplied mounting nuts. Mount the sensor securely to prevent any movement. If the sensor moves, the spot size will also move and may cause inaccurate measurements.

There are two cables exiting the Watlow IR Junior. These cables are marked on the label as "Input Voltage", and "Output Signal". These are the only connections required for sensor operation.

- For proper operation, make sure that all wiring connections are installed correctly and tightly.



## Input

The input voltage is 28VDC. The input module end of the cable has a (+) terminal connection.



**Note:** The input supply is erratic and should be connected with an air filter.

Input Power  
—  
Output Signal  
—

Figure 1

## Output

Dependent on the load, the output voltage will vary. A couple of connections are required.

<b>Output</b>
Type J
Type K
All voltage output
All current output

Connections (control)



## Input Power

The input power requirement for the Watlow IR Junior is +18 to 28VDC. The power cable contains an in-line signal module. See Figure 13 below. The red wire, located at the end of the power cable, must be connected to the positive (+) terminal of the power supply, while the black wire is connected to the negative (-) terminal of the power supply.

**Note:** The sensor output is non-isolated. If the power supply being used is non-isolated, noise problems may cause erratic readings. It may be necessary to utilize a power supply with an isolated output.

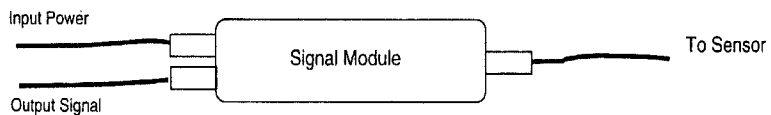

**Figure 13 - Input Power Connections**

## Output Signal

Depending upon the output type ordered, wire types will vary. All thermocouple outputs have the appropriate thermocouple wire type. The chart below shows the output type and connections for each.

Output Type	Color of Positive (+) Connection	Color of Negative (-) Connection
Type J t/c	White	Red
Type K t/c	Yellow	Red
All voltage output types	White	Black
All current output types	White	Black

Connect the output wires securely to an appropriate device (control, PLC, chart recorder etc.) with the proper polarity.

## Installation

### DIN-Rail Mounting the Watlow IR Power Pack

1. Place the Watlow IR Power Pack upper mounting clip on the top edge of the DIN rail. See Figure 14 on the next page.
2. Press down firmly on the top front edge of the Watlow IR Power Pack, see Figure 14 *Mounting* for location. The control "snaps" securely onto the rail. If the control does not snap on, check to see if the DIN rail is bent. The DIN rail specification is DIN EN 50022, 35mm x 7.5mm. Minimum clipping distance is 1.37" (34.8mm), the maximum is 1.39" (35.3mm).

### Removing the Watlow IR Power Pack

1. Place your fingers on the release lever located at the base of the Watlow IR Power Pack. See Figure 14 *Removing*.
2. While gently pressing on the top of the case, above Terminals 1 - 9 (see *Removing* inset), pull forward on the release lever.

### Mounting the Watlow IR Power Pack

1. Using the control as a location template, mark both mounting holes.
2. Drill two 0.19" (5mm) diameter holes in desired panel location. See dimensions on page 9.

Tap drill size	for	Screw/thread size
#29 - 0.136 dia.		#8-32
3.3 mm		M4 x 0.7

Good se



**Figure 12**

### Angle

To reduc  
it is recor  
perpendi  
recomme  
from perj

**Note:**  
angle mir  
can be us

### Ambier

The Wati  
temperat  
the sens  
higher th

...e for  
...m)  
...ea of



ound  
e 1.5

m)  
1.50"

Manual

### Mounting

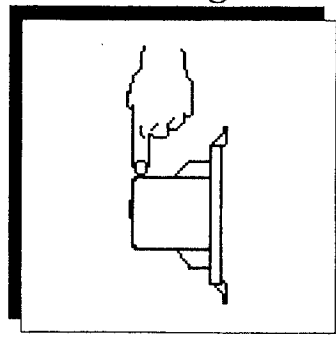

### Removing

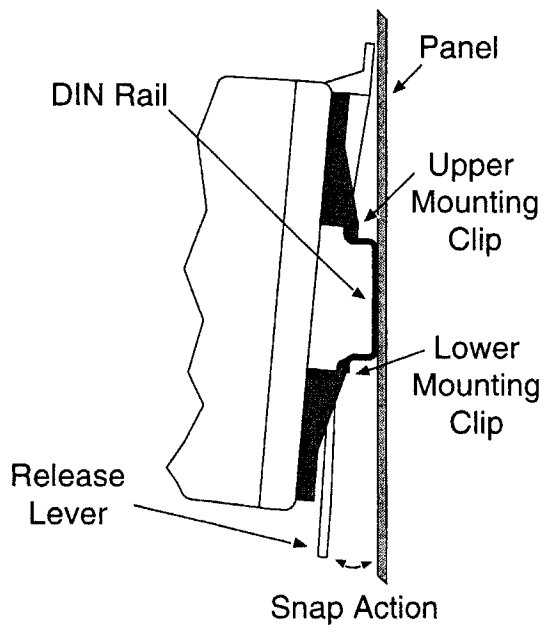
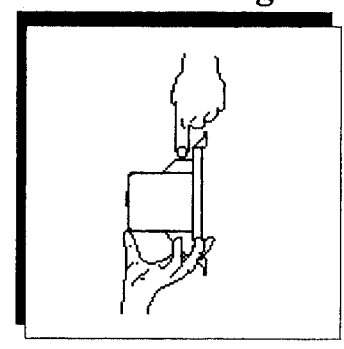

Figure 14 - Power Pack Side View Mounting

## Wiring the Watlow IR Power Pack



**WARNING:** To avoid potential electrical shock, use National Electric Code (NEC) safety practices when wiring and connecting this unit to a power source.

All wiring and fusing must conform to the National Electric Code and to any locally applicable codes also.

The input voltage is dependent upon part number. Check the terminal designation sticker on the side of the power supply for the correct input voltage.

POWR-PACK-1X00 120VAC,  $\pm 10\%$

POWR-PACK-2X00 230VAC,  $\pm 10\%$

POWR-PACK-3X00 200VAC,  $\pm 10\%$

POWR-PACK-4X00 100VAC,  $\pm 10\%$

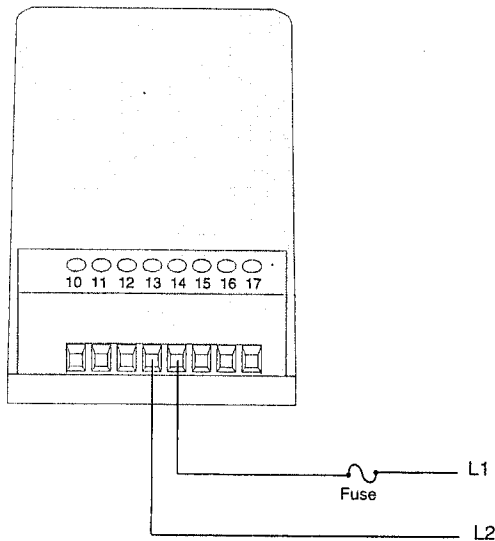

Figure 15 - Input Power Wiring

**Reflec**  
Material  
with the  
polished  
metals.  
or is cov  
surface

Figure 1

**Note:**  
material  
with a di  
contact

**Impro'**  
The sur  
proved l

User's Ma

nspar-  
ssum-  
ck).  
ive a  
pplica-

y not  
ese  
view  
re of

e  
sor  
,

Manual

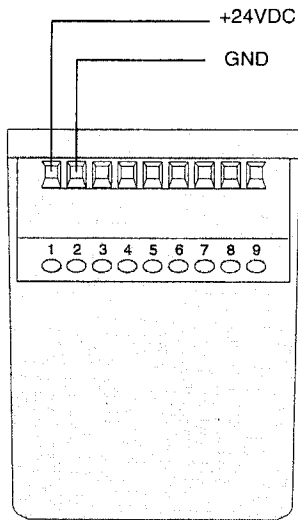

POWR-PACK-X100

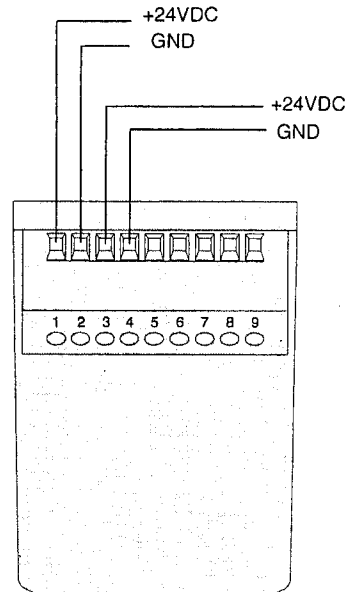

POWR-PACK-X200

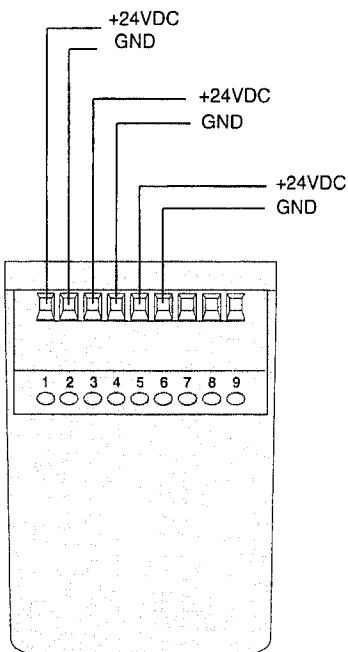

POWR-PACK-X300

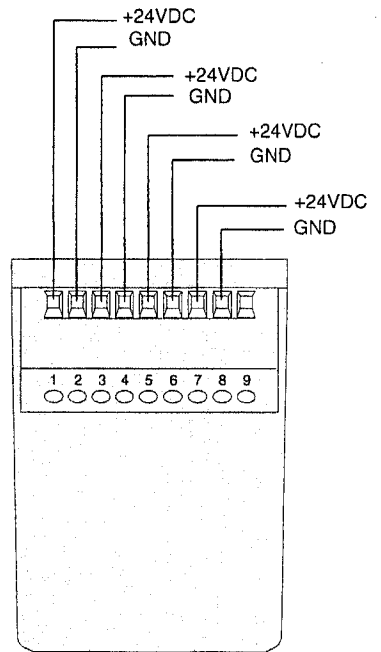

POWR-PACK-X400

Figure 16 - Output Wiring

The sensor may be operating properly even though the temperature reading is not exact, due to the emissivity of the object and the emissivity setting programmed in the Watlow IR Junior.

**Emissivity**

Emissivity is the ability of a surface to emit infrared energy. The amount of energy emitted by an object at a given temperature is proportional to the emissivity of that object. As the emissivity increases, the amount of energy increases and vice versa.

The standard Watlow IR Junior has an emissivity correction factor of 0.90. This provides a correction factor for the object's inability to emit energy.

If the emissivity of the object you are measuring is different than 0.90, there will be some differences in the temperature measurements between the infrared sensor and a contact sensor. Table 1 shows the amount of difference expected when measuring an object with an emissivity other than 0.90.

**Actual Emissivity**

Target Temp.	0.30	0.40	0.50	0.60	0.70	0.80	0.90	1.00
100	-8	-7	-6	-5	-4	-3	0	1
200	-69	-56	-44	-33	-22	-11	0	9
300	-124	-99	-78	-56	-37	-19	0	16
400	-176	-141	-109	-80	-52	-26	0	24
500	-227	-182	-141	-103	-68	-33	0	31
600	-278	-224	-174	-127	-83	-41	0	39
700	-331	-266	-207	-152	-99	-49	0	47
800	-384	-310	-241	-177	-116	-57	0	55
900	-438	-354	-276	-203	-133	-66	0	63

**Table 1 - Expected Temperature Differences Due to Emissivity**

**Prepar**

 Be manual noise. I ture rea noisy er

**Good**

The sen high em material rubber, 1 painted with a hi

**Figure 8**

o sensor  
n)

If the emissivity of the object you are measuring is not approximately 0.90, the following conditions are normal:

- ↑ The infrared sensor will measure a higher temperature reading than actual, if the emissivity is higher than 0.90.
- ↓ The infrared sensor will measure a lower temperature reading than actual, if the emissivity is lower than 0.90.

The difference in temperature measurements is not a function of sensor accuracy. *It is strictly due to the inaccuracy in the emissivity setting.* The sensor will measure properly if the emissivity of the object and the emissivity setting in the sensor are matched.

o  
(mm)

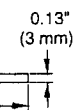

## Out of Limits Parameters

The Watlow IR Junior has over and under limit protection. The following chart represents the condition of the output signal if a limit is exceeded:

Limit Condition	Type J Type K	0-5VDC 0-10VDC	0-20mA	4-20mA
Sensing temperature overrange	Upscale	Upscale	Upscale	0mA
Sensing temperature underrange	Upscale	Upscale	Upscale	0mA
Ambient temperature overrange	Upscale	Upscale	Upscale	0mA
Ambient temperature underrange	Upscale	Upscale	Upscale	0mA

Thread s  
18 UN-

**Figure 2**

---

**Figure 3**

---

1.00"  
(25 mm)

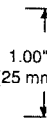

**Figure 4**



## Troubleshooting Guide

Symptom	Probable Cause	Solution
No output	Incorrect power applied to the sensor.	Check power supply.
	Polarity of the power is incorrect.	Reverse polarity.
Sensor reading is too high	Incorrect output type.	Verify output type.
	Emissivity of the object is lower than the emissivity set in the sensor.	This is normal. See Page 23.
Sensor reading is too low.	Lens is dirty.	Clean lens.
	Incorrect output type.	Verify output type.
	Emissivity of object is higher than the emissivity set in the sensor.	This is normal. See Page 23.

 **Note:** An easy method to check if the sensor is functioning properly is to boil water and measure its temperature. It should measure 212°F (100°C) if functioning correctly.

## Custom Parameters for Sensors

The Watlow IR Junior has three different operating parameters that can be factory set. These parameters are:

- Emissivity and window correction factor
- Output signal filter
- Temperature range

### Emissivity and Window Correction Factor

The standard Watlow IR Junior has an emissivity correction factor of 0.90. This should be close for most applications, but can be changed to meet the needs of your application.

In some applications, the sensor may require being located out of an environment due to atmospheric conditions. In these types of applications, an infrared transmissive window material can be supplied to view through. If using an infrared transmissive window, a correction factor for the loss of signal must be calculated to get an accurate measurement.

### Output Filter

The Watlow IR Junior responds in 700 milliseconds which is much faster than contact type sensors such as thermocouples, RTD's and thermistors. Because of this faster response, the output of the infrared sensor may not appear stable. Wandering measurements may also be contributed to inconsistent surface conditions or the emissivity of the targeted object.

### Temperature Range

The temperature sensing range of the sensor can be changed to meet the needs of the application.

 **Note: For more details on custom parameters, contact your Watlow representative.**

### Agenc

- UL a
- Pater

### Enviro

- NEM

### Weight

- 5.1 o

### Respo

- 700 r

(3 tir

- 350 r

(2 tir

- 233 r

(1 tir

### Conne

#### Input

- Input

#### Output

- Therr

- Volta

- Curre

### Cable l

- 3.0' (C

### IR Ju

### Require

- 5 P.S

### Air Qua

- Filtere

### Air Fitti

- Accep

### Input V

POWER-PACK- 00

**Input Voltage**

- 1 = 120VAC, ±10%, 50/60 Hz
- 2 = 230VAC, ±10%, 50/60 Hz
- 3 = 200VAC, ±10%, 50/60 Hz
- 4 = 100VAC, ±10%, 50/60 Hz

**Sensor Connections**

- 1 = 1
- 2 = 2
- 3 = 3
- 4 = 4

**Cable Extension Kit Ordering Information**

JRCE - 000 - 00

**Output Signal Type**

- 1 = Type "J" thermocouple
- 2 = Type "K" thermocouple
- 3 = 0 to 5VDC
- 4 = 0 to 10VDC
- 5 = 4 to 20mA
- 6 = 0 to 20mA

**Extension Length**

01 to 99 ft. (1m - 3.281 feet)

J R A -0 0 0 0-0 0 0 0

**Output Selection**

- 1 = Type "J" thermocouple
  - 2 = Type "K" thermocouple
  - 3 = 0-5VDC
  - 4 = 0-10VDC
  - 5 = 4-20mA
  - 6 = 0-20mA
- 

**Sensor with Air Purge Collar Attachment**

J R B -0 0 0 0-0 0 0 0

**Output Selection**

- 1 = Type "J" thermocouple
  - 2 = Type "K" thermocouple
  - 3 = 0-5VDC
  - 4 = 0-10VDC
  - 5 = 4-20mA
  - 6 = 0-20mA
- 

**Sensor with Right Angle Mirror Attachment**

J R C -0 0 0 0-0 0 0 0

**Output Selection**

- 1 = Type "J" thermocouple
- 2 = Type "K" thermocouple
- 3 = 0-5VDC
- 4 = 0-10VDC
- 5 = 4-20mA
- 6 = 0-20mA

**Accessories**

Mounting bracket

**Part Number**

0216-0860-0001