



Series 988LF

User's Manual

Includes 986L, 987L, 988L, and 989L



1/8 DIN Microprocessor-Based Temperature/Process Controller

User Level Targeted:

- New User go to page i
- Experienced User..... go to page 2.1
- Expert User..... go to page A.8

Installers:

- Setup go to page 4.1
- Wiring & Installation..... go to page 2.1

CE 96



ISO 9001



Registered Company
Winona, Minnesota USA



Watlow Controls

1241 Bundy Boulevard, P.O. Box 5580, Winona, Minnesota USA 55987-5580
Phone: (507) 454-5300, Fax: (507) 452-4507 <http://www.watlow.com>

0600-0009-0000 Rev C

October 1999
Supersedes: 0600-0009-0000 Rev B

\$10.00

Made in the U.S.A.



Printed on Recycled Paper 10% Postconsumer Waste

Table of Contents

Introduction to the Watlow Series 988LF Controllers

- ii Using this Manual
- ii Document Every Step
- iii Notes, Cautions and Warnings
- iii Technical Assistance
- iii We Value Your Feedback

Chapter 1

Hardware Setup

- 1.1 Dip Switch Locations and Functions

Chapter 2

Installation and Wiring

- 2.1 Panel Cutout and Dimensions
- 2.2 Installing the Series 988LF
- 2.3 Wiring the Series 988LF
- 2.3 Input-to-output Isolation
- 2.3 Power Wiring
- 2.3 Sensor Installation Guidelines
- 2.4 Wiring 0-20mA and 4-20mA Process Inputs
- 2.5 Wiring Example
- 2.7 Input 1 Wiring
- 2.8 Remote Set Point Option Wiring
- 2.9 Output 1 Wiring
- 2.10 Output 2 Wiring

Chapter 3

Front Panel and Display Loop

- 3.1 Keys and Displays
- 3.2 Display Loop

Chapter 4

The Setup Menus

- 4.1 Navigating the Setup Menus
- 4.2 Setup Prompts

Chapter 5

The Operation Menus

- 5.1 Navigating the Operation Menus
- 5.2 Display Prompts

Chapter 6

The Factory Menus

- 6.1 Reaching the Diagnostics Menu
- 6.5 Reaching the Calibration Menu

Chapter 7

Tuning, Manual Operation, Alarms and Error Codes

- 7.1 Auto-tuning (Heat and/or Cool)
- 7.2 Manual Tuning
- 7.3 Manual and Automatic Operation
- 7.4 Using Alarms
- 7.5 Error Code E1 and E2 Messages
- 7.6 Error Code Actions

Appendix

- A.1 Warranty and Returns
- A.2 Glossary
- A.4 Index
- A.6 Specifications
- A.7 Model Number
- A.8 Menu Overview
- A.9 Declaration of Conformity

Introduction To The Watlow Series 988LF Controllers

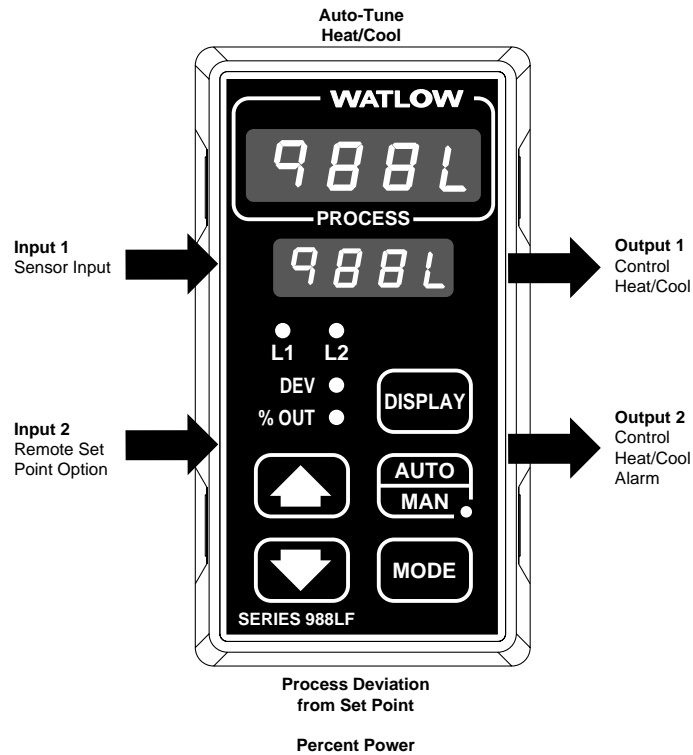

Figure Int.1 - The Series 988LF Features.

Welcome to the Watlow Series 988LF, a dual output, single input, micro-processor-based, 1/8 DIN, auto-tuning temperature control, featuring automatic/manual capability with bumpless transfer. In the Auto mode, the control has closed loop control with sensory feedback, while the Manual mode has open loop control with user defined output power level. The 988LF accepts a wide range of thermocouple sensors, along with RTD, and process inputs. The primary output is Heating or Cooling, while the secondary output can be Heating, Cooling, or Alarm.

With the Series 988LF, you can select either PID or ON/OFF for output 1 or Output 2. You may input a complete set of PID parameters for both outputs, or select automatic tuning for both heat and cool from the front panel. This includes proportional band, reset, rate, and cycle time. By setting either output's proportional band to zero, the Series 988LF becomes a simple ON/OFF control with a 3°F or 1.7°C switching differential, 0.3°F or 0.17°C for 0.1° RTD.

Operator-friendly features include automatic LED indicators to aid in monitoring and setup, as well as a calibration offset at the front panel. The Watlow Series 988LF automatically stores all information in a non-volatile memory.

Using this Manual

This manual provides the information you will need to install and operate a Series 988LF controller.

If you need information about Series 988LF configurations and model numbers, refer to the Appendix of this manual.

This manual explains the five steps of setting up a Series 988LF controller:

1. Set and document all of the DIP switches, if applicable: Chapter 1.
2. Mount the controller: Chapter 2.
3. Wire and document the controller wiring: Chapter 2.
4. Configure and document the controller software: Chapters 3-6.
5. Run, test and adjust your application. Update documentation.

The Appendix provides definitions and specifications, along with application examples to help you optimize the safety and performance of your application. Use the Table of Contents and Index to find specific information.

NOTE:

The 12-digit number is printed on the top of the stickers on each side of the controller's case and on the right-hand or top circuit board.

Document Every Step

The Series 988LF provides powerful control features. Carefully document each step of the setup and any subsequent changes. This will make it much easier to change, adjust and troubleshoot your application.

Make the configuration documentation available to engineers and technicians, on all shifts, who may need to work with the Series 988LF. We provide space in this manual to record configurations. You may prefer to photocopy the blank forms and keep them in a separate binder. However, you maintain your documentation; be sure to replace all old copies of the documentation with updated versions whenever the controller configuration is changed.

NOTE:

The Menu Overview in the Appendix shows all of the menus and prompts.

Notes, Cautions and Warnings

We use note, caution and warning symbols throughout this book to draw your attention to important operational and safety information.

A bold text “**NOTE**” marks a short message in the margin to alert you to an important detail.

A bold text “**CAUTION**” safety alert appears with information that is important for protecting your equipment and performance. **Be especially careful to read and follow all cautions that apply to your application.**

A bold text “**WARNING**” safety alert appears with information that is important for protecting you, others and equipment from damage. **Pay very close attention to all warnings that apply to your application.**

The  symbol (an exclamation point in a triangle) precedes a general CAUTION or WARNING statement.

The  symbol (a lightning bolt in a triangle) precedes an electric shock hazard CAUTION or WARNING safety statement.

Technical Assistance

If you encounter a problem with your Watlow controller, review all of your configuration information for each step of the setup to verify that your selections are consistent with your applications.

If the problem persists, an Application Engineer can discuss your application with you.

Before calling, please have the complete model number and user’s manual available. You can get technical support by dialing 507/494-5656, 7 a.m. to 7 p.m. Central Standard Time, or e-mail to wintechsupport@watlow.com.

We Value Your Feedback

Your comments and suggestions on this manual are welcome. Please send them to, Technical Writer, Watlow Controls, P.O. Box 5580, Winona, MN 55987-5580, or call (507) 454-5300, or fax (507) 452-4507. The Series 988LF User’s Manual is copyrighted by Watlow Winona, Inc., © October 1999, with all rights reserved. (1831)

Notes

Chapter 1 Hardware Setup

DIP Switch Locations and Functions

The Watlow Series 988LF has at least one and as many as three dual in-line package (DIP) switches inside the controller, depending on the model number. **They allow users to configure the controller for a variety of input sensors, or to lockout front panel access to some functions.**

To set any DIP switch:

- Remove the controller from the case by pressing firmly on the two release tabs on one side or the top of the bezel until they unsnap. Then firmly press the two release tabs on the opposite side or the bottom of the control until they unsnap. You will need to gently rock the bezel back and forth to release it from the chassis.
- Use the illustrations on the following pages to locate and set each DIP switch.

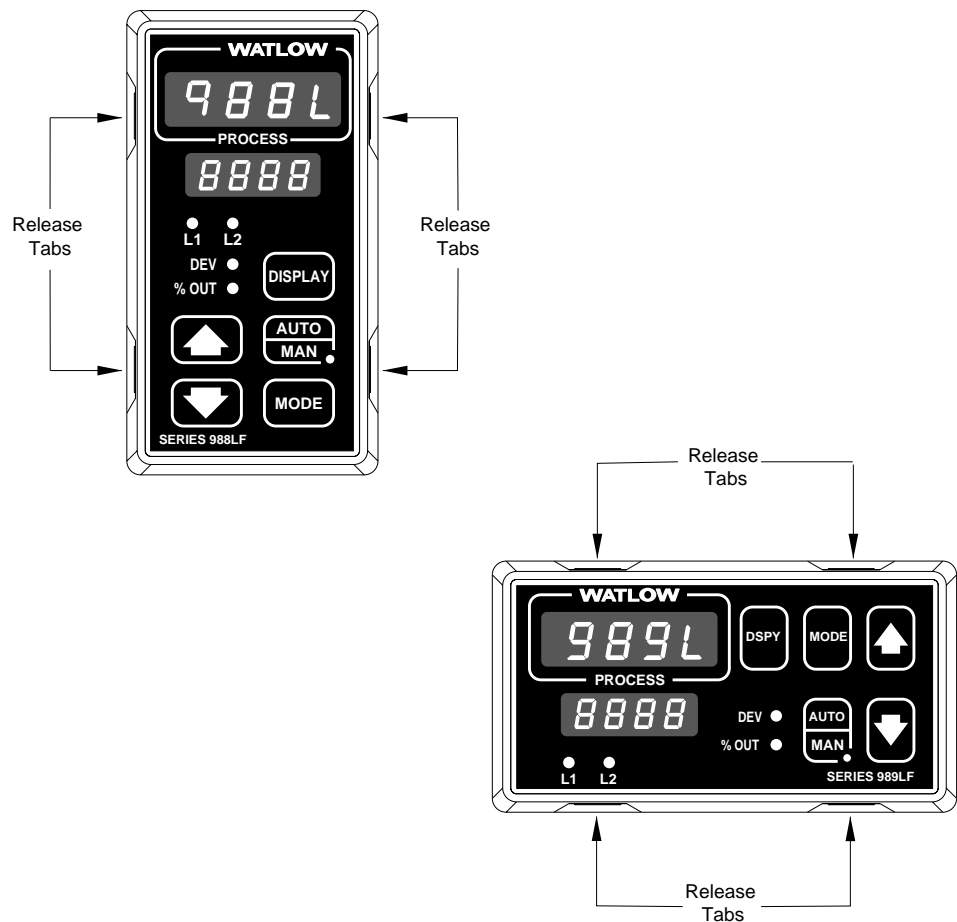
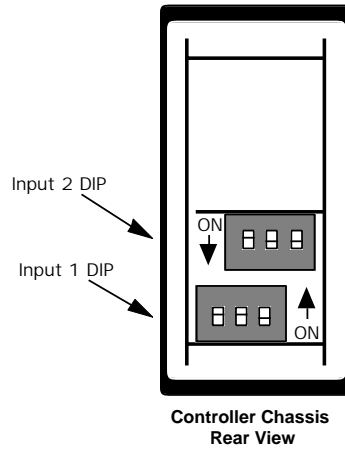

Figure 1.1 - Press the release tabs to remove the controller chassis.

DIP Switches

① Set the input DIP switches to match the sensors you are using in your application. Only controllers with model number 98_L-2__-AA__ or 98_L-__2__-AA__ have an input DIP switch.

NOTE:
The Input 2 DIP switch is mounted upside down.



NOTE:
Only controllers with the indicated model numbers have these DIP switches.

	Input 1 (98_L-2__-AA__)	Input 2 (Remote Set Point) (98_L-__2__-AA__)
RTD		
thermocouple: R, S or B		
thermocouple: J, K, T, N, E, C, D, Pt2 or 0-50mV (high impedance)		
0-20 or 4-20mA; 0-5, 1-5 or 0-10V		

Figure 1.2 -
Input DIP switches.

DIP Switches



CAUTION:
The lockout DIP switch makes the Setup and Factory menus unavailable. Configure all the Setup and Factory menus before locking them out. Failure to do so could result in damage to equipment in the event of a setup error.

Ⓢ The lockout DIP switch hides the Setup Menu and the Factory Menu (Diagnostics and Calibration). All units have a lockout DIP switch.

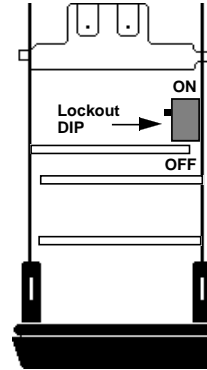

Control Chassis
Top View (986LF & 988LF)
Left-side View (987LF & 989LF)

no hardware lockout
(Switch 1 has no effect.)

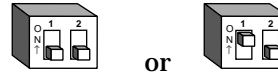

or

lockout Setup and Factory menus
(Switch 1 has no effect.)

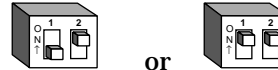

or

Figure 1.3 -
Lockout DIP switch.

Notes

Chapter 2 Installation and Wiring

NOTE:
Space panel cutouts at least 1.66 inches (42.2mm) apart.

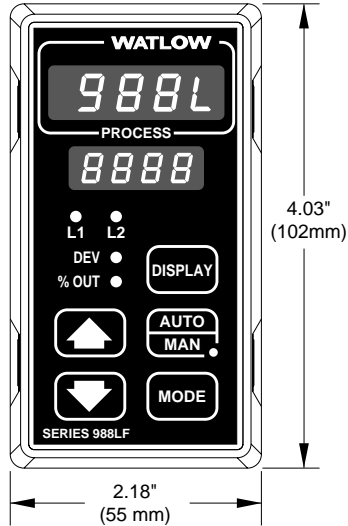

NOTE:
Adjustable mounting brackets can be side-mounted.

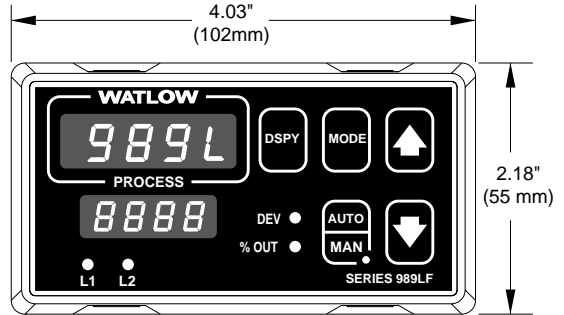

NOTE:
Holes can be cut in the panel using a Greenlee 1/8 DIN Hydraulic Kit #60068 (punch #60069, die #60070).

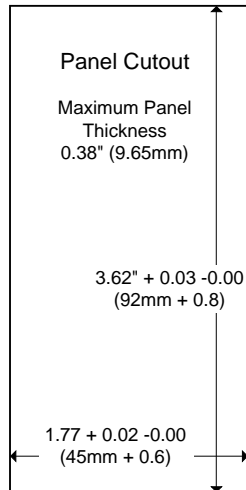
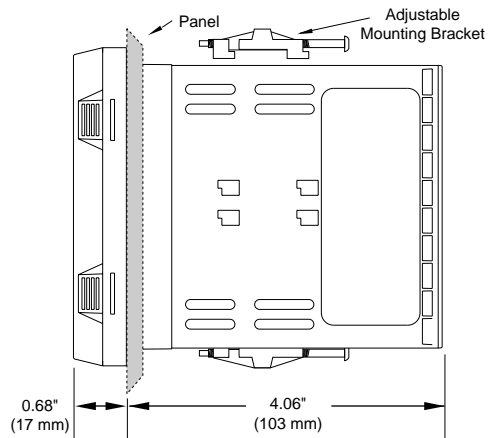

Figure 2.1 - Series 988LF and Series 989LF dimensions.



Installing the Series 988LF

Installing and mounting requires access to the back of the panel.

1. Make a panel cutout.
2. To remove the controller chassis from its case, press in firmly on the two tabs on one side or the top of the bezel until they unsnap, then unsnap the two tabs on the opposite side or the bottom. Pull the chassis out of the case by gently rocking it.
3. Slide the case into the panel cutout. Check to see that the gasket is not twisted, and is seated within the case bezel flush with the panel. Slide the mounting collar over the back of the control.

NOTE:

Removing the controller chassis from its case makes mounting easier.

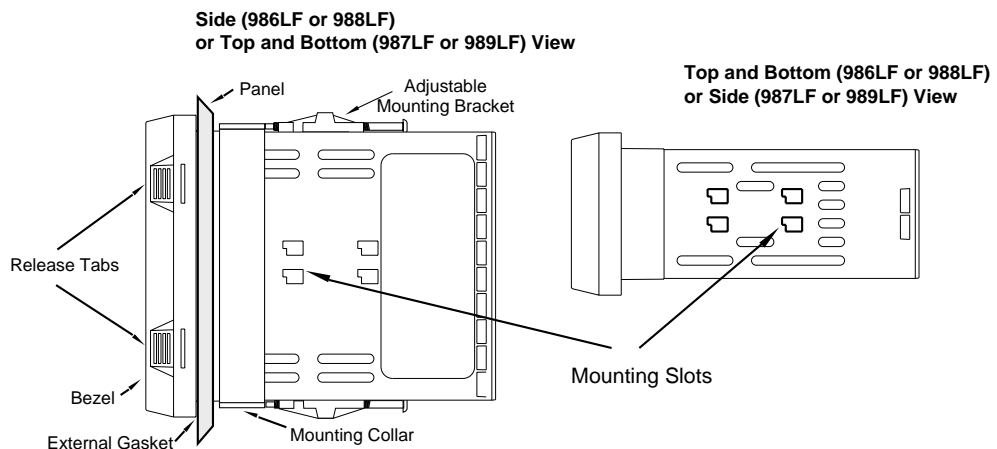

Figure 2.2 - Side and top view.

4. Loosen the mounting bracket screws enough to allow for the mounting collar and panel thickness. Place each mounting bracket into the mounting slots (head of the screw facing the back of the controller). Push each bracket backward then down to secure it to the control case. **To guarantee a proper NEMA 4X seal, Series 986LF and 988LF units (vertical) must have the mounting brackets located on either side of the unit. When installing Series 987LF and 989LF units (horizontal) the brackets must be on the top and bottom of the unit.**
5. Make sure the case is seated properly. Tighten the installation screws firmly against the mounting collar to secure the unit. **To ensure a NEMA 4X seal, there should be no space between the bezel and panel.** Overtightening the screws will distort the case and make it difficult to remove or replace the controller.
6. Insert the controller chassis into its case and press the bezel until all four tabs snap. Make sure the inside gasket is seated properly and not twisted.
7. To release the mounting brackets, loosen the mounting bracket screws and push the brackets forward, then pull it up and out.



CAUTION:

Follow the installation procedure exactly to guarantee a proper NEMA 4X seal. Make sure the gasket between the panel and the rim of the case is not twisted and is seated properly. Failure to do so could result in damage to equipment.



WARNING:
To avoid potential electric shock, use National Electric Code (NEC) safety practices when wiring and connecting this unit to a power source and to electrical sensors or peripheral devices. Failure to do so could result in injury or death.

Wiring the Series 988LF

Wiring options depend on the model number and DIP switch settings. Check the terminal designation stickers on either side of the controller and compare your model number to those shown here and with the model number breakdown on the inside back cover of this manual.

Input-to-output Isolation

The Series 988LF uses optical isolation between the analog inputs and the controller outputs. This isolation provides a 500V~ (ac) barrier to prevent ground loops when using grounded sensors and/or peripheral equipment.

Here is a breakdown of the isolation barriers:

- Analog inputs 1 and 2 are grouped together.
- Outputs 1 and 2 are grouped together.

Power Wiring

100 to 240 V~ (ac), nominal (85 to 264 actual)

Vertical Package	98 8 L - _ _ _ _ - A A _ _
Horizontal Package	98 9 L - _ _ _ _ - A A _ _

24 to 28 V≈ (ac/dc), nominal (20 to 30 actual)

Vertical Package	98 6 L - _ _ _ _ - A A _ _
Horizontal Package	98 7 L - _ _ _ _ - A A _ _

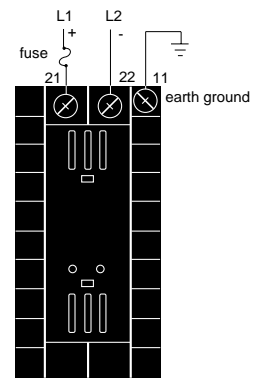

Figure 2.3 - Power wiring.



CAUTION:
The Series 988LF will not function with two grounded thermocouple inputs. Avoid using a grounded thermocouple for both input 1 and input 2. Failure to follow this guideline could result in damage to equipment.

Sensor Installation Guidelines

Thermocouple input: Extension wire for thermocouples must be of the same alloy as the thermocouple itself to limit errors.

Using grounded thermocouples for both input 1 and remote set point option may create ground loop problems. To correct this problem, replace at least one of the grounded thermocouples with an ungrounded thermocouple. If the application requires grounded thermocouples, use an isolated transmitter, such as a Watlow Gordon 5702 isolated transmitter.

RTD input: Each 1Ω of lead wire resistance can cause a +2°F error when using a two-wire RTD. A three-wire RTD sensor overcomes this problem. All three wires must have the same electrical resistance (i.e., same gauge, same length, multi-stranded or solid, same metal).

Process input: Maintain isolation between input 1 and input 2 to prevent a ground loop. A ground loop may cause incorrect readings, dashes across the upper display or the display of error codes.

Wiring 0-20 and 4-20mA Process Inputs

Certain “transmitters” used in process input applications are producing internal resistor failures in the Watlow Series 988 family of controllers. This is only apparent with the Series 988 family 1/8 DIN units with Process Inputs selected (0-20mA or 4-20mA dc only).

We are noticing that an external resistor is required to prevent a high in-rush current which burns out the Series 988 family controllers’ 7-ohm internal resistor. This high in-rush current occurs initially on “power-up.” If the transmitter turns full on for a split second during power-up, the available current weakens or damages the internal resistor.

Example: $20V / 7 \text{ ohms} = 2,857\text{mA}$ (too much!).

The wiring diagram example below shows an application where a customer is using a 4-20mA dc transmitter and power supply to feed the input of a Series 988 controller. The Rx range (100 to 400 ohms) for the external resistor is recommended. We suggest starting with 250 ohms.

Example: Customer is using a 24V \approx (dc) power supply to power up the 4-20mA dc transmitter that inputs to the Series 988 terminals 8 (-) and 10 (+). To figure out what the internal Series 988’s handling current is for the 0-20mA or 4-20mA dc input to the Series 988 controllers, we need to apply Ohm’s Law: The square root of Watts divided by Resistance equals Current. Applying that formula to the example below produces the following: Square Root of (0.125 Watts / 7 ohms) = 134 mA dc (handling input current). This is the acceptable input current for the Series 988 universal input board.

Figure 2.4 - Process wiring example.

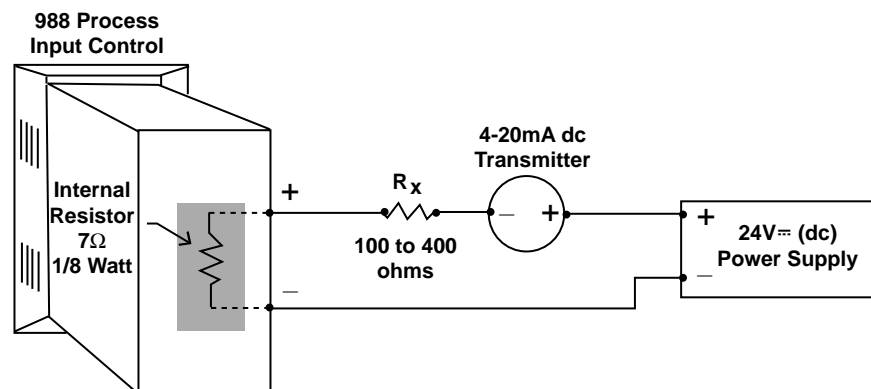

Reminder, the input impedance of 7 ohms handles the majority of our customer applications; the external resistor (Rx) is only for certain transducers/transmitters that spike on power-up or power-down. Please make sure your customer’s transmitter / transducer fall within our Series 988 family (1/8 DIN) of controllers’ Process Input specification of 7 ohms input impedance.



WARNING:
To avoid potential electric shock, use National Electric Code (NEC) safety practices when wiring and connecting this unit to a power source and to electrical sensors or peripheral devices. Failure to do so could result in injury or death.



WARNING:
Install high or low temperature limit control protection in systems where an over temperature fault condition could present a fire hazard or other hazard. Failure to install temperature limit control protection where a potential hazard exists could result in damage to equipment, property and injury to personnel.



WARNING:
To avoid damage to property and equipment, and/or injury of loss of life, use National Electric Code (NEC) standard wiring practices to install and operate the Series 988LF. Failure to do so could result in such damage, and/or injury or death.

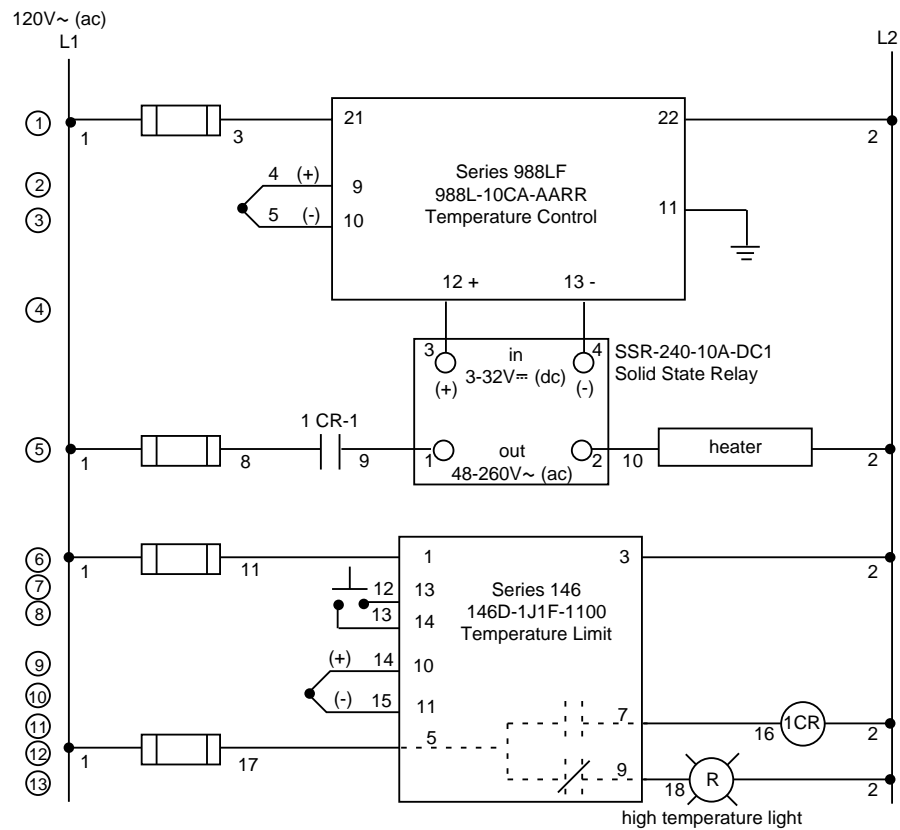
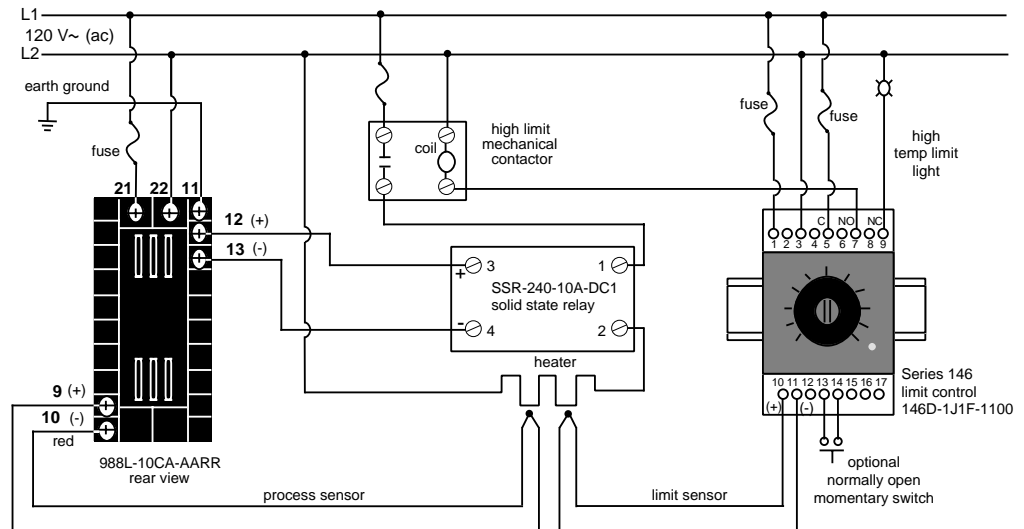

Figure 2.5 -
System wiring
example.

Wiring Notes



WARNING:
To avoid damage to property and equipment, and/or injury of loss of life, use National Electric Code (NEC) standard wiring practices to install and operate the Series 988LF. Failure to do so could result in such damage, and/or injury or death.

NOTE:
Sketch in your application on this page or a copy of it. See wiring examples in this chapter and in the Appendix.

Figure 2.6 -
Wiring notes.

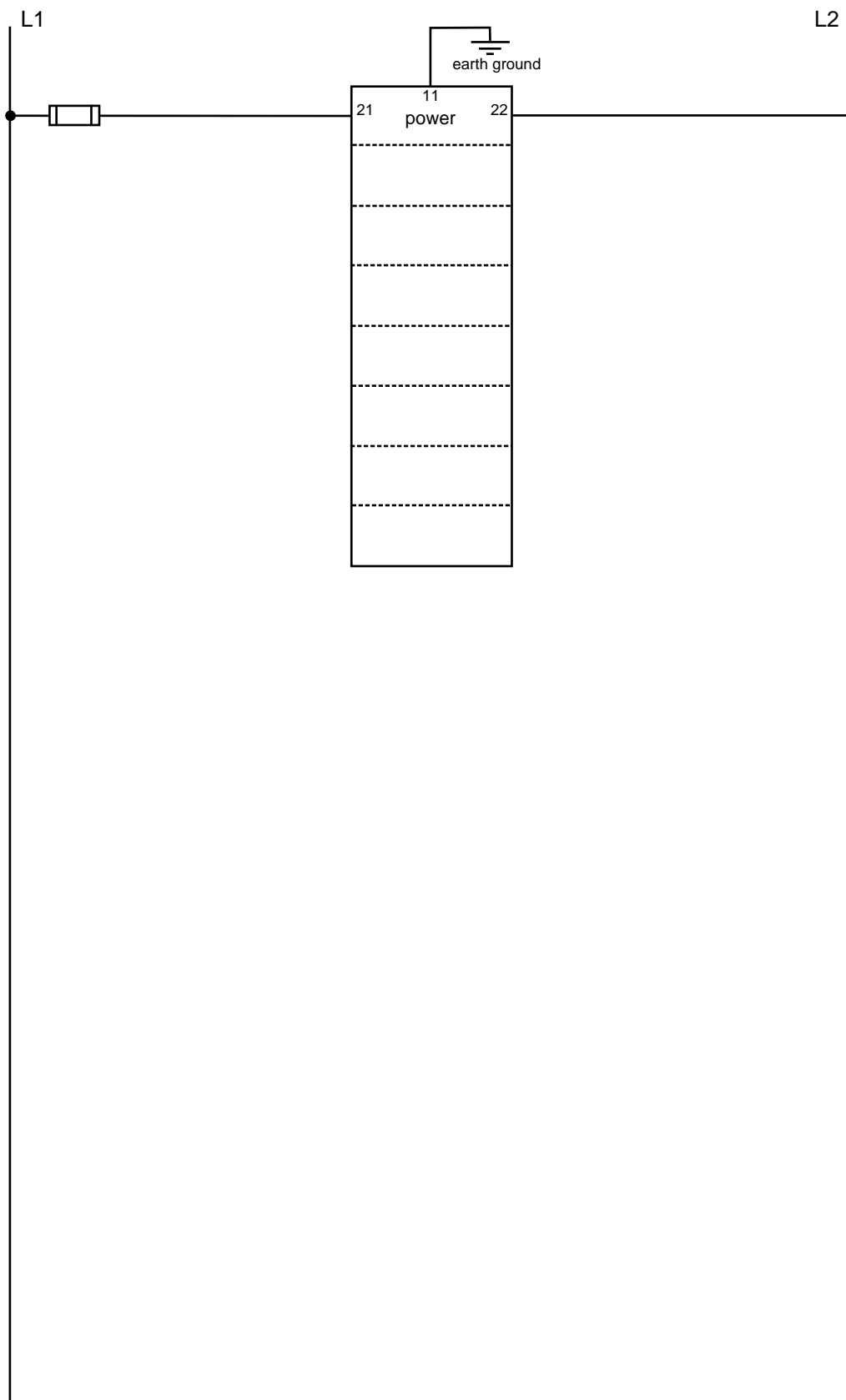

Figure 2.7a — Thermocouple or 0-50mV (high impedance)

NOTE:
Successful installation requires five steps:

- Model number and software choice (Appendix);
- DIP switch settings (Chapter 1);
- Sensor match (Chapter 2 and Appendix);
- Sensor installation (Chapter 2); and
- Wiring (Chapter 2).

Thermocouple only
 98 _ L - 1 _ _ _ - A A _ _ (no DIP switches)

Universal signal conditioner
 98 _ L - 2 _ _ _ - A A _ _

Input impedance: 20M Ω

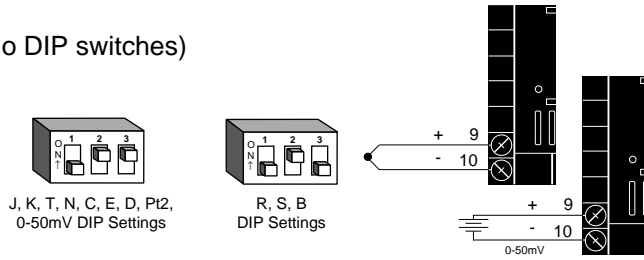
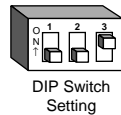

Figure 2.7b — RTD (2 or 3 Wire) 100 Ω

Universal signal conditioner
 98 _ L - 2 _ _ _ - A A _ _



Jumper
 #9 to #10
 for 2 wire
 RTD

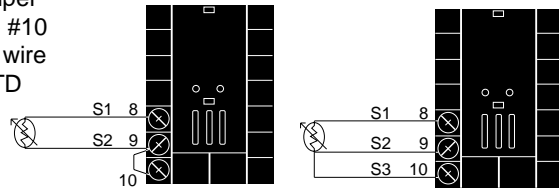
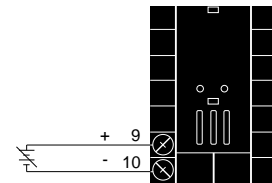
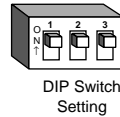

Figure 2.7c — 0-5V $\overline{\text{m}}$, 1-5V $\overline{\text{m}}$ or 0-10V $\overline{\text{m}}$ (dc) Process

Universal signal conditioner
 98 _ L - 2 _ _ _ - A A _ _

Input impedance: 10K Ω



CAUTION:
 An external resistor is required for 0-20mA and 4-20mA process wiring to prevent a high in-rush current which could burn out the controller's 7-ohm resistor. See page 2.4 for recommendations.

Figure 2.7d — 0-20mA or 4-20mA Process

Universal signal conditioner
 98 _ L - 2 _ _ _ - A A _ _

Input impedance: 7 Ω

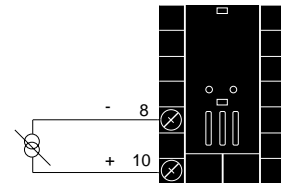
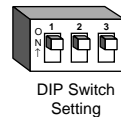

Input 2 Wiring

- NOTE:**
 Successful installation requires five steps:
- Model number and software choice (Appendix);
 - DIP switch settings (Chapter 1);
 - Sensor match (Chapter 2 and Appendix);
 - Sensor installation (Chapter 2); and
 - Wiring (Chapter 2).

Figure 2.8a — Thermocouple or 0-50mV (high impedance)

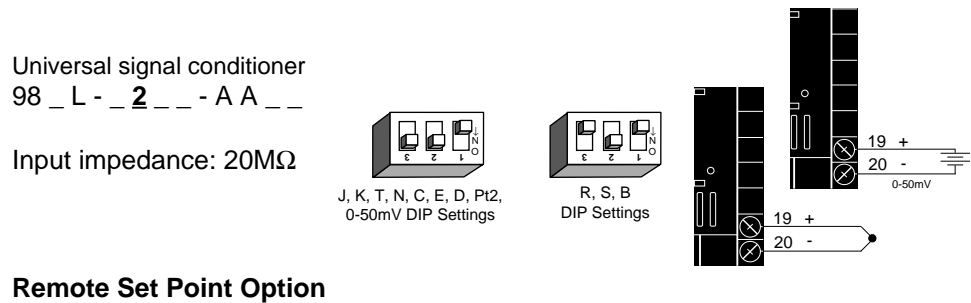

Figure 2.8b — RTD (2 or 3 Wire) 100Ω

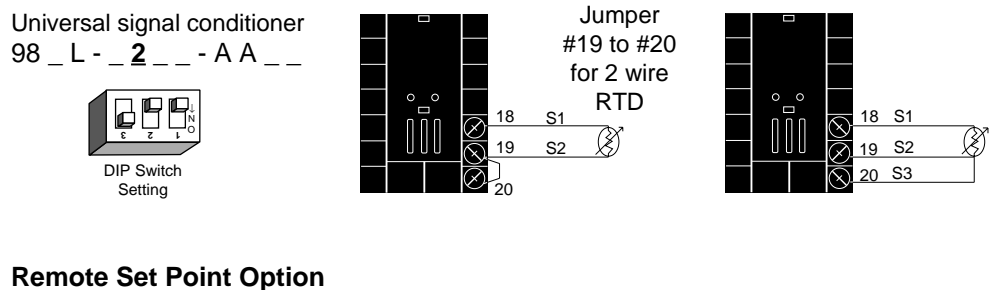
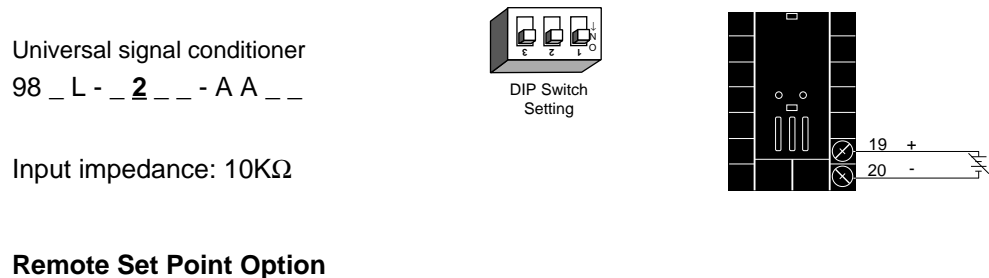

Figure 2.8c — 0-5V_{DC}, 1-5V_{DC} or 0-10V_{DC} (dc) Process



CAUTION:
 An external resistor is required for 0-20mA and 4-20mA process wiring to prevent a high in-rush current which could burn out the controller's 7-ohm resistor. See page 2.4 for recommendations.

Figure 2.8d — 0-20mA or 4-20mA Process

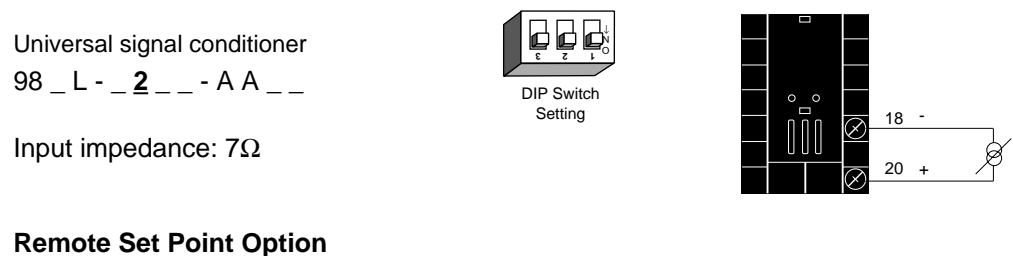

Figure 2.9a — AC Outputs

NOTE:

Successful installation requires five steps:

- Model number and software choice (Appendix);
- DIP switch settings (Chapter 1);
- Sensor match (Chapter 2 and Appendix);
- Sensor installation (Chapter 2); and
- Wiring (Chapter 2).

Solid-state Relay *with* Contact Suppression

98 _ L - _ _ **B** _ - A A _ _

0.5 amps, minimum off-state impedance: 20KΩ

Electromechanical Relay *with* Contact Suppression

(NO and COM contacts only)

98 _ L - _ _ **D** _ - A A _ _

Form C, 5 amps, minimum off-state impedance: 20KΩ

Electromechanical Relay *without* Contact Suppression

98 _ L - _ _ **E** _ - A A _ _

Form C, 5 amps off-state impedance: 31MΩ

Solid-state Relay *without* Contact Suppression

98 _ L - _ _ **K** _ - A A _ _

0.5 amps, off-state impedance: 31MΩ

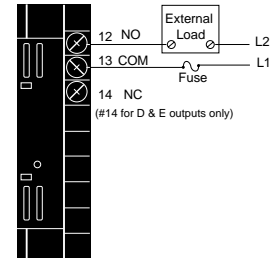

Figure 2.9b — Switched DC, Open Collector

98 _ L - _ _ **C** _ - A A _ _

Minimum load resistance: 500Ω

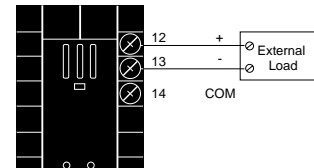
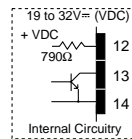

Figure 2.9c — 0-20mA and 4-20mA Process

98 _ L - _ _ **F** _ - A A _ _

Maximum load impedance: 800Ω

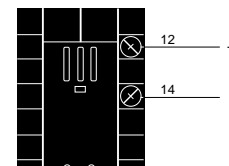
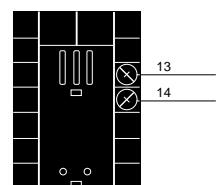

Figure 2.9d — 0-5V_{rms}, 1-5V_{rms} and 0-10V_{rms} (dc) Process

98 _ L - _ _ **F** _ - A A _ _

Minimum load impedance: 1KΩ



Output 2 Wiring

NOTE:

Successful installation requires five steps:

- Model number and software choice (Appendix);
- DIP switch settings (Chapter 1);
- Sensor match (Chapter 2 and Appendix);
- Sensor installation (Chapter 2); and
- Wiring (Chapter 2).

Figure 2.10a — AC Outputs

Solid-state Relay *with* Contact Suppression

98 _ L - _ _ _ B - A A _ _

0.5 amps, minimum off-state impedance: 20KΩ

Electromechanical Relay *with* Contact Suppression

(NO and COM contacts only)

98 _ L - _ _ _ D - A A _ _

Form C, 5 amps, minimum off-state impedance: 20KΩ

Electromechanical Relay *without* Contact Suppression

98 _ L - _ _ _ E - A A _ _

Form C, 5 amps off-state impedance: 31MΩ

Solid-state Relay *without* Contact Suppression

98 _ L - _ _ _ K - A A _ _

0.5 amps, off-state impedance: 31MΩ

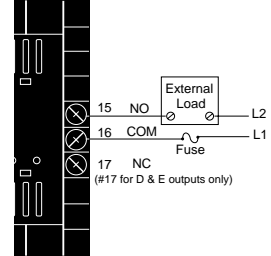
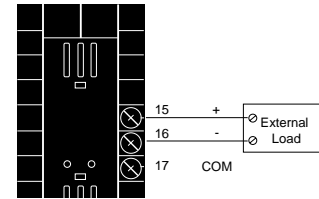
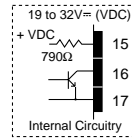

Figure 2.10b — Switched DC, Open Collector

98 _ L - _ _ _ C - A A _ _

Minimum load resistance: 500Ω



Chapter 3 Front Panel and Display Loop

Keys and Displays

Upper Display

Indicates the actual process value, prompt parameter value or error code.

DEV LED

When lit, the lower display shows the current deviation from the set point.

% OUT LED

When lit, the lower display shows the current percent output.

Up-arrow Key

Increases the value or changes the parameter in the upper display (except for set point changes in the Display Loop, which occur in the lower display). Hold the key down to increase the value rapidly. New data takes effect in five seconds or when the Mode key or Display key is pressed.

Down-arrow Key

Decreases the value or changes the parameter in the upper display (except for set point changes in the Display Loop, which occur in the lower display). Hold the key down to decrease the value rapidly. New data takes effect in five seconds or when the Mode key or Display key is pressed.

Up + Down Keys

Press simultaneously for three seconds to go to the Setup Menu. Continue to press both keys for another three seconds to go to the Factory Menu. Access to the Setup and Factory menus can be disabled with lockout DIP switch.

Lower Display

Indicates the set point, deviation, percent power, temperature unit, menu prompt name or alarm code.

L1, L2

These LED's indicate when output 1 or 2 are active. Outputs can be configured as:
Ot1 Control
Ot2 Control or Alarm

Display Key

Pressing this key enters the Display Loop. Press the Display key at any time to return to this loop. The next page has more information on the Display Loop.

Auto/Man Key

In Manual mode the lower display shows percent output. Pressed once, it clears a latched alarms. If pressed again within five seconds it will toggle between Auto and Manual mode.

Auto/Man LED

Lit when the control is in Manual operation. Press the Auto/Man key twice to enter Automatic operation. When blinking, press the Auto/Man key to toggle between Auto and Manual. After five seconds without pressing the Auto/Man key, the LED stops blinking and returns to its previous state.

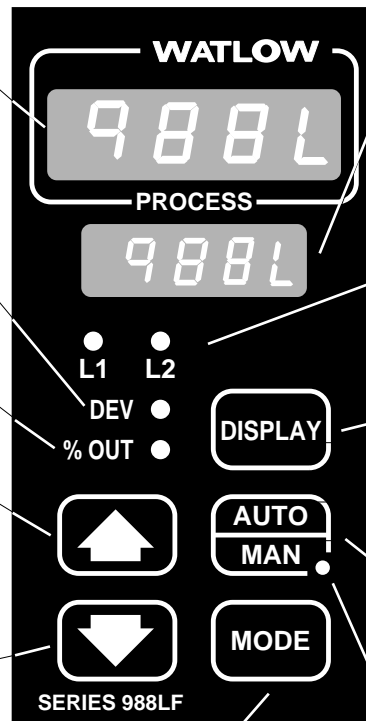

Mode Key

Enters new data and steps to the next prompt in the current menu.

Mode + Up-arrow Keys

Hold the Mode key then press the Up-arrow key to move backwards through the current menu. Scrolling stops when you reach the top of the menu.

Figure 3.1 - Series 988LF Keys and Displays

Display Loop

Display Loop

The Display Loop is the “home” state of the Series 988LF controller. Pressing the Display key  returns the controller to the Display Loop from any prompt in any menu. The controller automatically returns to the Display Loop from any menu when a minute passes without any keys being pressed.

NOTE:
For information on input 1  ranges, refer to Chapter 4.

Figure 3.2 -
The Display Loop



Chapter 4 The Setup Menu

Navigating the Setup Menu

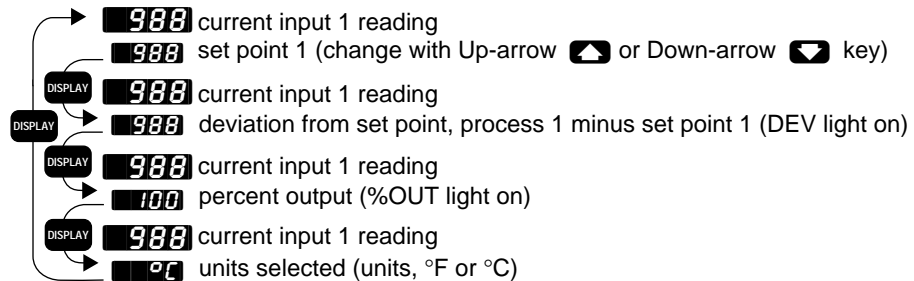
The Setup Menu displays the parameters that configure the Series 988LF's features to your application.

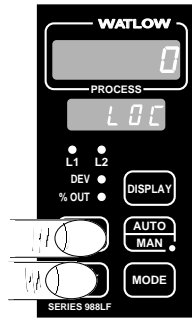

① To enter the Setup Menu, press the Up-arrow and Down-arrow keys for three seconds. The lower display shows the LOC prompt, and the upper displays shows its current level. All keys are inactive until you release both keys.

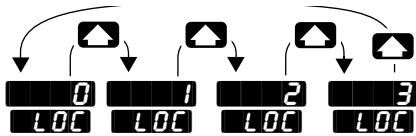

② Press the Up-arrow or the Down-arrow key to select one of the prompt values

Figure 4.1 - The Setup Menu

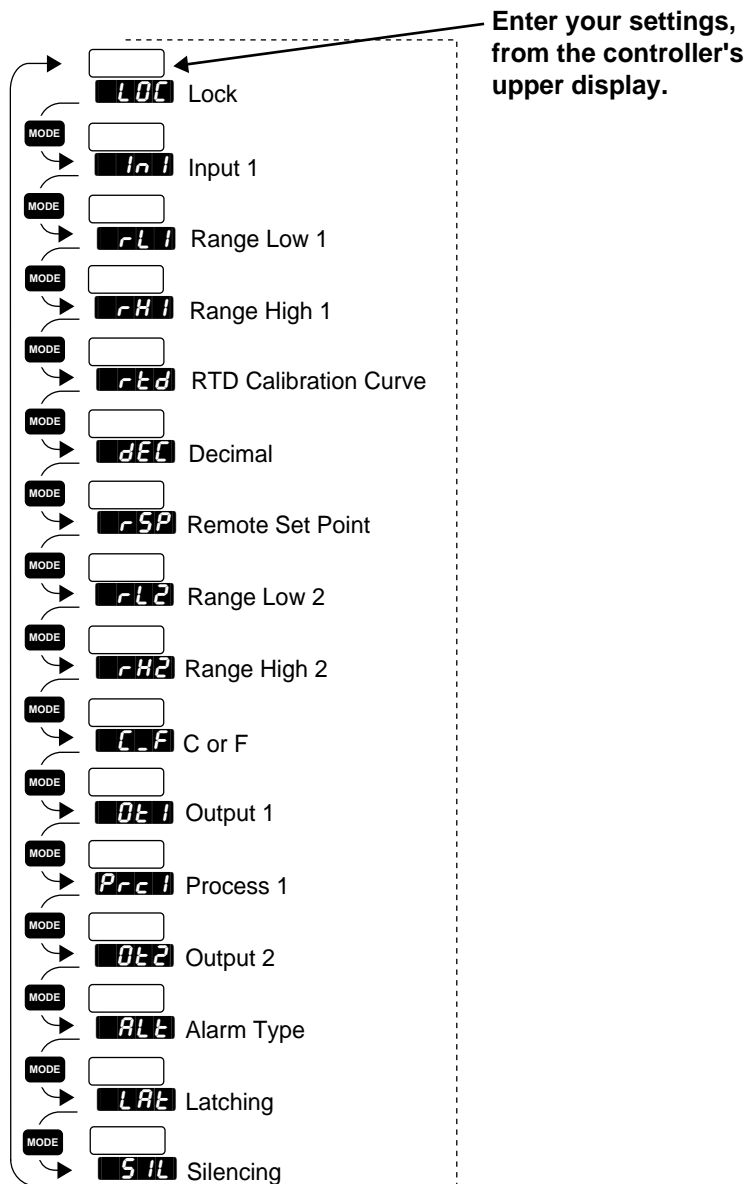

Setup

Setup Prompts



③ Use the Mode key **MODE** to advance through the Setup Menu. You will not see every prompt in the Setup menu; the unit's configuration and model number determine which prompts appear.

NOTE:

Decimal points may not always be in the position specified depending on the settings in the Decimal **DEC** parameters in the Setup Menu.

④ Use the Up-arrow **▲** and Down-arrow **▼** keys to change the prompt setting. To move backwards through the menu hold the Mode key **MODE** down and press the Up-arrow key **▲**. Refer to the Appendix for model number options.

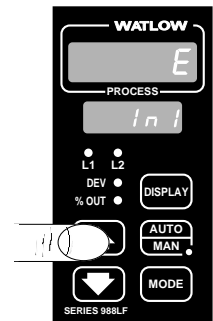

Caution:

Setting **LOC** to **0** or **3** disables the Auto/Man key **AUTO MAN** and will force the controller into manual mode if an open sensor occurs. Verify that the controller is operating in the desired mode (auto or manual) before setting the lockout level. Failure to do so could result in damage to equipment and/or property.

Front Panel Lockout

Sets the lockout level for the front panel. This allows you to disable keys on the front of the controller.

- **0** enables all keys.
- **1** disables the Mode key **MODE**.
- **2** disables the Mode key **MODE** and the Auto/Man key **AUTO MAN**.
- **3** disables all keys.

LOC This prompt always appears.

Default

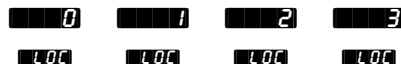

lnl



Caution:

Changing the value of **lnl** changes most other prompts to the factory default values. Verify the correct sensor type before making a change. Failure to follow this guideline could result in damage to equipment or property.

Input 1

Select sensor input type. This selection must match the sensor type connected to terminals 8, 9 and 10. See Appendix for more information about sensors.

- Changing the value of **lnl** changes all other prompts to the factory default values, **LOC** Lock prompt and the **CLF** prompt in the Setup Menu. If you change the value, the default warning **dFLt** will flash in the upper display.
- Changes do not take effect automatically after five seconds; you must press the Mode key **MODE** to enter the selector type change and advance to the next prompt.

lnl This prompt always appears.

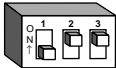
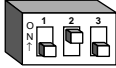
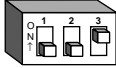
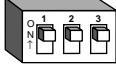
	If ↓	Default ↓								
98_L-1__-AA__										
no DIP	J	K	T	N	E	W5	W3	Pt2	0-50mV	
	lnl	lnl	lnl	lnl	lnl	lnl	lnl	lnl	lnl	lnl
thermocouple only	lnl	lnl	lnl	lnl	lnl	lnl	lnl	lnl	lnl	lnl
98_L-2__-AA__										
Input 1 DIP thermocouple	J	K	T	N	E	W5	W3	Pt2	0-50mV	
	lnl	lnl	lnl	lnl	lnl	lnl	lnl	lnl	lnl	lnl
Input 1 DIP thermocouple	R	S	B							
	lnl	lnl	lnl							
Input 1 DIP RTD	RTD	RTD(0.1°)								
	lnl	lnl								
Input 1 DIP process	4-20mA	0-20mA	0-5V _{rms}	1-5V _{rms}	0-10V _{rms} (dc)					
	lnl	lnl	lnl	lnl	lnl					

Setup

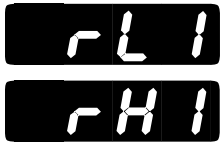

Range Low and Range High

Select the low and high range for input 1. These prompts limit the adjustment range for the set points. The default values are the same as the limits of the sensor you selected by setting the input DIP switch and selecting a value for Input **in1**.

- Process inputs are scaled by these values. Range high is the value displayed when the maximum process signal is present at the input. Range low is the value displayed when the minimum process signal is present at the input.

NOTE:
These values do not affect the low or the high set point limit for process alarms.

Example: Set **in1** to **4-20** mA.
Set **rL1** to **100**.
Set **rH1** to **500**.
A 4mA input will display **100**.
A 12mA input will display **300**.
A 20mA input will display **500**.

- The low and high values of each sensor type are listed on the specifications page of the Appendix.
- Choose between Fahrenheit and Celsius at the **C_F** prompt in the Setup Menu.

rL1 rH1 These prompts always appear.

	Default ↓	Default ↓	Default ↓	Default ↓
	OF	OC		
	rL1	rH1	rL1	rH1
in2	32...1500	0...816	rL1	rH1
				98_L-1__-AA__ or 98_L-2__-AA__
(K)				
H	-328...2500	-200...1371		
t	-328...750	-200...399		
n	32...2372	0...1300		
E	-328...1470	-200...799		
(W5)				
L	32...4200	0...2316		
(W3)				
d	32...4200	0...2316		
Pt2	32...2543	0...1395		
high impedance				
0-50	-999...999	-573...573		
r	32...3200	0...1760		98_L-2__-AA__ only
S	32...3200	0...1760		

NOTE:
When high impedance **0-50** is selected for Input 1, the range high for both **OC** and **OF** can be extended to **9999**. The range low, when **OC** is selected, can be extended to **-999**.



Range Low and Range High continued on next page.

rl1
rhl1

Range Low and Range High continued from previous page.

NOTE:
The range high **rhl1** value for process inputs can be extended to **9999**.

	Default ↓	Default ↓	Default ↓	Default ↓
	°F		°C	
	rl1	rhl1	rl1	rhl1
b	32	3300	0	1816
rtd	-328	1472	-200	800
rtd	-999	9999	-733	5377
process				
4-20	-999	999		units
0-20	-999	999		units
0-5	-999	999		units
1-5	-999	999		units
0-10	-999	999		units
0-50	-999	999		units

rtd

RTD Calibration Curve

Select the RTD calibration curve. The RTD input uses either the European (DIN, 0.003850 ohms/ohms/°C) or Japanese (JIS, 0.003916 ohms/ohms/°C) linearization standard.

rtd This prompt appears only if you have set **in1** to **rtd** or **rtd**.

Default
↓

din **jis**
rtd **rtd**

Setup

dEC

Decimal

Select the decimal point location for process type input 1 data. This prompt, in conjunction with the Range Low and Range High prompts, allows you to format and limit units of measure for process 1.

- All prompts with units of measure related to input 1 will display in the selected decimal format.
- This affects propbands, alarm set points, process set points, calibration offsets, deadbands and ranges.

dEC This prompt appears only if you have set input 1 **in1** to a process input or a thermocouple input set to **0-50** mV.

Default
↓

0.0000
dEC dEC dEC dEC

rSP

Remote Set Point Input

Enable a remote set point signal. The remote set point input selection switches are set to process at the factory.

rSP This prompt appears only on controllers equipped with Remote Set Point Input hardware (98 _ L_ 2__-AA_).

If Default
↓ ↓

RSP Input DIP

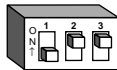

thermocouple

	J	K	T	N	E	W3	W5	Pt2	0-50mV
OFF	J	H	t	n	E	C	d	Pt2	0-50
rSP	rSP	rSP	rSP	rSP	rSP	rSP	rSP	rSP	rSP

RSP Input DIP

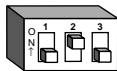

thermocouple

	R	S	B
OFF	r	S	b
rSP	rSP	rSP	rSP

RSP Input DIP

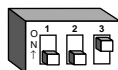

RTD

	RTD	RTD(0.1°)
OFF	rtD	rtD
rSP	rSP	rSP

rSP

Remote Set Point Input
continued on next page.

rSP

Remote Set Point Input
continued from previous
page.

If ↓	Default ↓					
RSP Input DIP		4-20mA	0-20mA	0-5V _m	1-5V _m	0-10V _m (VDC)
		OFF	4-20	0-20	0-5	1-5
process (Factory Preset)		rSP	rSP	rSP	rSP	rSP
RSP Input DIP		4-20mA	0-20mA	0-5V _m	1-5V _m	0-10V _m (VDC)
		OFF	4-20	0-20	0-5	0-10
mV process		rSP	rSP	rSP	rSP	rSP

rL2

rH2

Range Low 2 and Range High 2

Select the low and high range for Remote Set Point Input. These prompts limit the adjustment range for the set points. The default values are the same as the limits of the sensor you selected by setting the input 2 DIP switch and selecting a value for Input 2 **ln2**.

rL2 **rH2** These prompts appear only on controllers equipped with Remote Set Point Input hardware (98_L_2_AA_).

- Process inputs are scaled by these values. Range high is the value displayed when the maximum process signal is present at the input. Range low is the value displayed when the minimum process signal is present at the input.

Example: Set **rSP** to **4-20** mA.
 Set **rL2** to **100**.
 Set **rH2** to **500**.
 A 4mA input will display **100**.
 A 12mA input will display **300**.
 A 20mA input will display **500**.

- The low and high values of each sensor type are listed on the specifications page of the Appendix.
- Choose between Fahrenheit and Celsius at the **L_F** prompt in the Setup Menu.

rL2 **rH2** These prompts appear only if the controller is equipped with Remote Set Point Input hardware and with Remote Set Point Input **rSP** not set to **OFF**.

Default ↓	Default ↓	Default ↓	Default ↓	
OF	OF	OF	OF	
rL2	rH2	rL2	rH2	
32..1500	0..816	0..816	0..816	98_L-1-AA_ or
rL2	rH2	rL2	rH2	98_L-2-AA_

rL2

rH2

Range Low 2 and Range High 2
continued on next
page.

Setup

rL2

rH2

Range Low 2 and Range High 2 continued from previous page.

NOTE:

These values do not affect the low or the high set point limit for process alarms.

NOTE:

When high impedance **0-50** is selected for Input 1, the range high for both **°C** and **°F** can be extended to **9999**. The range low, when **°C** is selected, can be extended to **-999**.

NOTE:

The range high **rH2** value for process inputs can be extended to **9999**.

C-F

Default	Default ↓ ↓	Default ↓ ↓
(K) H	°F -328...2500	°C -200...1371
t	-328...750	-200...399
n	32...2372	0...1300
E	-328...1470	-200...799
(W5) C	32...4200	0...2316
(W3) d	32...4200	0...2316
Pt2	32...2543	0...1395
high impedance 0-50	-999...999	-573...573
r	32...3200	0...1760
S	32...3200	0...1760
b	32...3300	0...1816
rtd	-328...1472	-200...800
rtd	-999...9999	-733...5377
process 4-20	-999...999	units
0-20	-999...999	units
0-5	-999...999	units
1-5	-999...999	units
0-10	-999...999	units
0-50	-999...999	units
0-100	-999...999	units

98_L-2__AA__ only

Celsius-Fahrenheit

Select which temperature scale the controller will use.

C-F This prompt appears only on controllers with either Input 1 set to something other than a process input.

Default
↓

°F **°C**
C-F **C-F**

0t1

Output 1

Set the way that output 1 will respond to a difference between the set point and an input variable.

- **HE** (Heat) select reverse action, so that output 1 responds when the input signal is less than the setpoint.
- **CL** (Cool) select direct action, so that output 1 responds when the input signal is more than the setpoint.

0t1 This prompt always appears.

Default



HE **CL**
0t1 **0t1**

Process 1

Select the process range for output 1.

- **Proc1** This prompt appears only on controllers equipped with output 1 process hardware (98__F__).

Default



4-20mA	0-20mA	0-5V _m	1-5V _m	0-10V _m (dc)
4-20	0-20	0-5	1-5	0-10
Proc1	Proc1	Proc1	Proc1	Proc1

Output 2

Selects the secondary output action

- **AL** de-energizes output 2 in an alarm condition.
- **ALn** energizes output 2 in an alarm condition.
- **HE** (Heat) selects reverse action, so that output 2 responds when the input signal is less than the set point.
- **CL** (Cool) selects direct action, so that output 2 responds when the input signal is more than the set point.

0t2 This prompt appears only on controllers equipped with output 2 hardware (not 98_L__A-AA__).

Default



no **AL** **ALn** **HE** **CL**
0t2 **0t2** **0t2** **0t2** **0t2**

Proc1

0t2

Setup

AL2

Alarm Type

Selects the alarm type when Output 2 has been selected as an alarm.

- **Pr** uses the process signal from input 1.
- **dE** uses a deviation from the input 1 signal.

AL2 This prompt appears only on controllers equipped with output 2 hardware (not 98_L-__A-AA__). and with **0t2** set to **AL** or **ALn**.

Default



Pr **dE**
AL2 **AL2**

LAL

Latching

Select whether alarm for output 2 will be latching or non-latching. A latching alarm **LAL** must be turned off manually. A non-latching alarm **nLA** turns off when an alarm condition no longer exists.

LAL This prompt appears only on controllers equipped with output 2 hardware (not 98_L-__A-AA__) and with **0t2** set to **AL** or **ALn**.

Default



nLA **LAL**
LAL **LAL**

SIL

Silencing

Select silencing to inhibit alarm for Output 2 on startup and to allow the operator to reset the alarm output, not the visual display.

- Silencing disables the alarm until the signal is between **R2LO** and **RH1**.

AL2 This prompt appears only on controllers equipped with output 2 hardware (not 98_L-__A-AA__) and with **0t2** set to **AL** or **ALn**.

Default



OFF **On**
SIL **SIL**

Chapter 5 The Operation Menu

Navigating the Operation Menus

NOTE:
Press the Display Key **DISPLAY** to return to the Display Loop from any point in any menu.



① To reach the Operation Menus, begin in the Display Loop and press the Mode key **MODE**. Depending on the controller configuration, either the Set Point 2 prompt **SP2**, or the Proportional Band, Output 1 prompt **Pb1** will appear in the lower display. You will not see every prompt in the Operation Menu; the unit's configuration and model number determine which prompts appear.

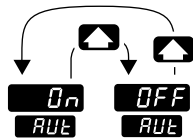

② Use the Up-arrow **▲** or the Down-arrow **▼** key to select one of the prompt values.

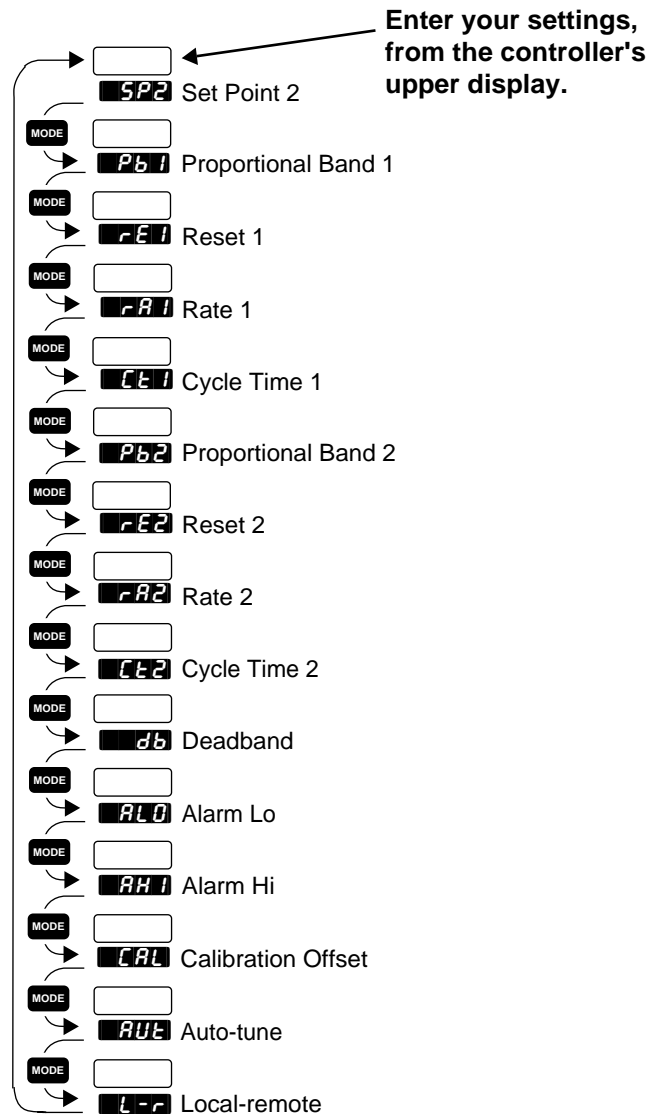

Figure 5.1 - Navigating the Operations Menu.

Operations

NOTE:
 Decimal points may not always be in the position specified below depending on the settings in the Decimal **dEC** parameters in the Setup Menu.

Display Prompts



③ Use the Mode key **MODE** to advance through the Operations Menu. You will not see every prompt in the Operations menu; the unit's configuration and model number determine which prompts appear.

④ Use the Up-arrow **▲** and Down-arrow **▼** keys to change the prompt setting. To move backwards through the menu hold the Mode key **MODE** down and press the Up-arrow key **▲**. Refer to the Appendix for model number options.

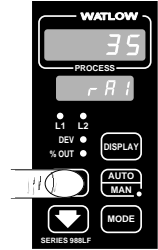

Set Point 2

Select a second set point that will activate output 2. This allows you to boost the heating (reverse acting) or cooling (direct acting) action of the output 1 device.

- The range and default settings depend on the **ln1**, **rL1**, and **rH1** settings (Setup Menu).

SP2 This prompt appears only if **0t1** and **0t2** (Setup Menu) are both set to **HE** or **CL**.

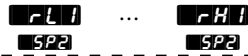

Proportional Band, Output 1

Select the proportional band for PID output 1. If set to **0** it functions as an on/off control with a 3°F or 1.7°C switching differential for ranges displayed in whole degrees, and 0.3°F or 0.17°C for ranges displayed on 0.1°. The default is 25°F/17°C.

Pb1 This prompt always appears.

	If ↓	Default ↓
(Setup Menu)	0F C.F	0 ... 25 ... 9999 Pb1 Pb1 Pb1
Input 1 (Setup Menu)	rtd	00 25 9999 Pb1 Pb1 Pb1
(Setup Menu)	0F C.F	0 ... 14 ... 9999 Pb1 Pb1 Pb1
Input 1 (Setup Menu)	rtd	00 ... 14 ... 9999 Pb1 Pb1 Pb1

rE1

Reset, Output 1

Tune the control action to eliminate the offset or droop between the set point and the actual process value for PID output 1.

rE1 This prompt appears only if **Pb1** is set to greater than **0**.

Default



000 ... **9999** repeats/min.
rE1 **rE1**

rA1

Rate, Output 1

Tune the rate to eliminate overshoot on startup or after the set point changes for Output 1. The rate setting will not influence the percent power if the process value is more than twice the proportional band from the set point.

rA1 This prompt appears only if **Pb1** is set to greater than **0**.

Default



000 ... **999** min.
rA1 **rA1**

CE1

Cycle Time, Output 1

Select the time, in seconds, of a complete on/off cycle.

CE1 This prompt appears only if **Pb1** is set to greater than **0**. This prompt does not appear if Output 1 is a process output.

If



Default



mechanical relay outputs **50** ... **100** ... **9999** min.
CE1 **CE1** **CE1**

open collector or solid-state relay outputs **brSt** **0.1** ... **10** ... **9999** min.
CE1 **CE1** **CE1**

Operations

Pb2

Proportional Band, Output 2

Select the proportional band for PID output 2. If set to **0** it functions as an on/off control. If set to **0** it functions as an on/off control with a 3°F or 1.7°C switching differential for ranges displayed in whole degrees, and 0.3°F or 0.17°C for ranges displayed on 0.1°. The default is 25°F/17°C.

Pb2 This prompt appears if Output 2 **0b2** (Setup Menu) is set to **Ht** or **CL**.

If	Default
0F CLF (Setup Menu)	0 ... 25 ... 9999 Pb2 Pb2 Pb2
rbd Input 1 (Setup Menu)	00 25 9999 Pb2 Pb2 Pb2
0C CLF (Setup Menu)	0 ... 17 ... 9999 Pb2 Pb2 Pb2
rbd Input 1 (Setup Menu)	00 ... 17 ... 9999 Pb2 Pb2 Pb2

rE2

Reset, Output 2

Tune the control action to eliminate the offset or droop between the set point and the actual process value for PID output 2.

rE2 This prompt appears only if **Pb2** is set to greater than **0**.

Default
000 ... 9999 repeats/min. rE2 rE2

rR2

Rate, Output 2

Tune the rate to eliminate overshoot on startup or after the set point changes for Output 2. The rate setting will not influence the percent power if the process value is more than twice the proportional band from the set point.

rR2 This prompt appears only if **Pb2** is set to greater than **0**.

Default
000 ... 999 min. rR2 rR2

ct2

Cycle Time, Output 2

Select the time, in seconds, of a complete on/off cycle.

ct2 This prompt appears if Output 2 **ot2** (Setup Menu) is set to **ht** or **cl**, and if **pb2** is set to greater than **0**.

If ↓	Default ↓
mechanical relay outputs	5.0 ... 10.0 ... 9999 min. ct2 ct2 ct2
open collector or solid-state relay outputs	0.1 ... 10 ... 9999 min. ct2 ct2 ct2

db

Dead Band

Select the width of the zone between the action of the heating (reverse acting) output and the cooling (direct acting) output. This shifts the cool setpoint by the dead band value entered. If you select a positive value the heat and cool outputs cannot be energized at the same time. If you select a negative value, both outputs can be energized at the same time.

If ↓	Default ↓
°F cl-f (Setup Menu)	-999 ... 0 ... 999 db db db
°C cl-f	-555 ... 0 ... 555 db db db
a process input is selected	-999 ... 0 ... 999 units db db db

Operations

AL0

Alarm Lo

Select the low trigger value for the output 2 alarm. Represents the low process alarm or low deviation alarm.

AL0 This prompt appears only if **0L2** parameter is set to **AL** or **ALn**.

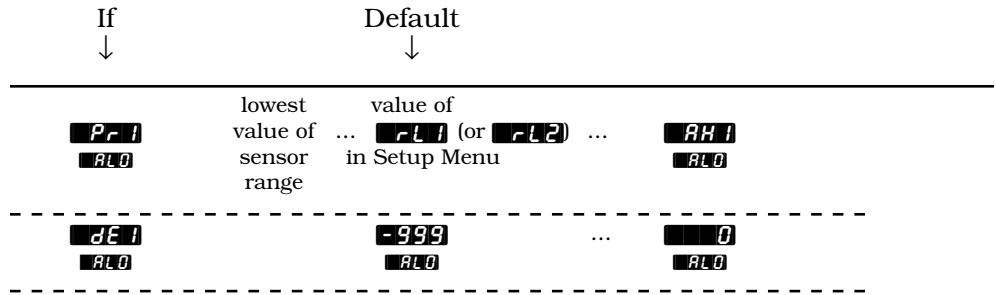

AH1

Alarm Hi

Select the high trigger value for the output 2 alarm. Represents the high process alarm or high deviation alarm.

AH1 This prompt appears only if **0L2** parameter is set to **AL** or **ALn**.

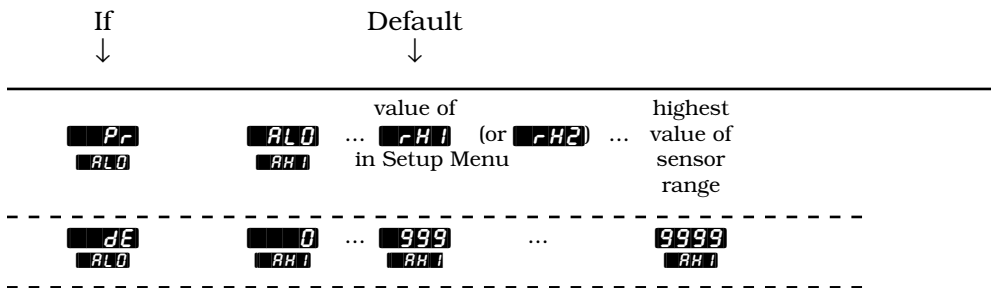

CAL

Calibration Offset

Add or subtract degrees from the input signal. This allows you to compensate for lead resistance, sensor errors, or other factors.

CAL This prompt always appears.

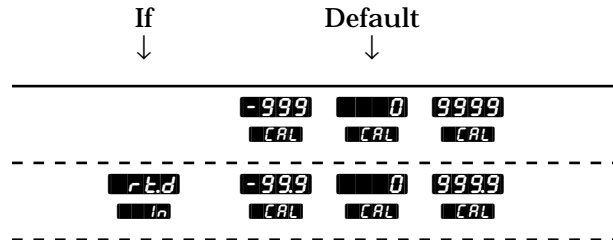

AUT

NOTE:
For more information on auto-tune, see Chapter 7.

Auto-tune

Initiate an auto-tune.

AUT This prompt always appears.

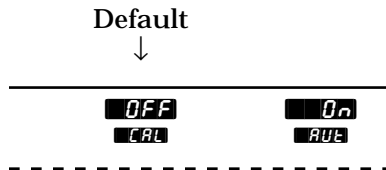

L-r

Local-remote

Selects a local or remote set point. With **L-r** selected the controller displays the remote set point rather than the internal (local) set point, and the set point cannot be changed with the Up-arrow or Down-arrow key.

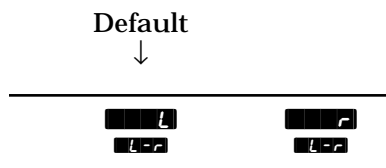

L-r This prompt appears if **rSP** (Setup Menu) is not equal to **OFF**.





Notes

Chapter 6 The Factory Menus

Reaching the Diagnostics Menu

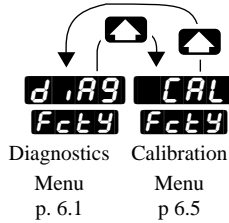

1 Press the Up-arrow  and Down-arrow  keys together and hold until the **LOL** prompt appears in the lower display. Press and hold again until the **Fcty** prompt appears in the lower display.

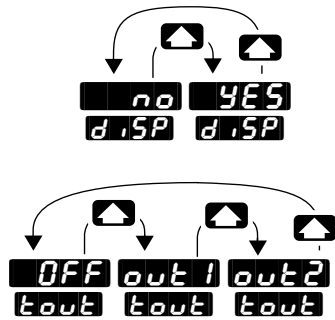

2 Use the Up-arrow  key to step from the Calibration Menu **CAL** to the Diagnostics Menu **d.i.a.g**.

3 Press the Mode key **MODE** to step through the prompts.



4 Press the Up-arrow key  or the Down-arrow key  to select one of the prompt values.

In the Diagnostics Menu only the values of **d.i.s.p**, **t.out**, and **OPLP** can be changed.

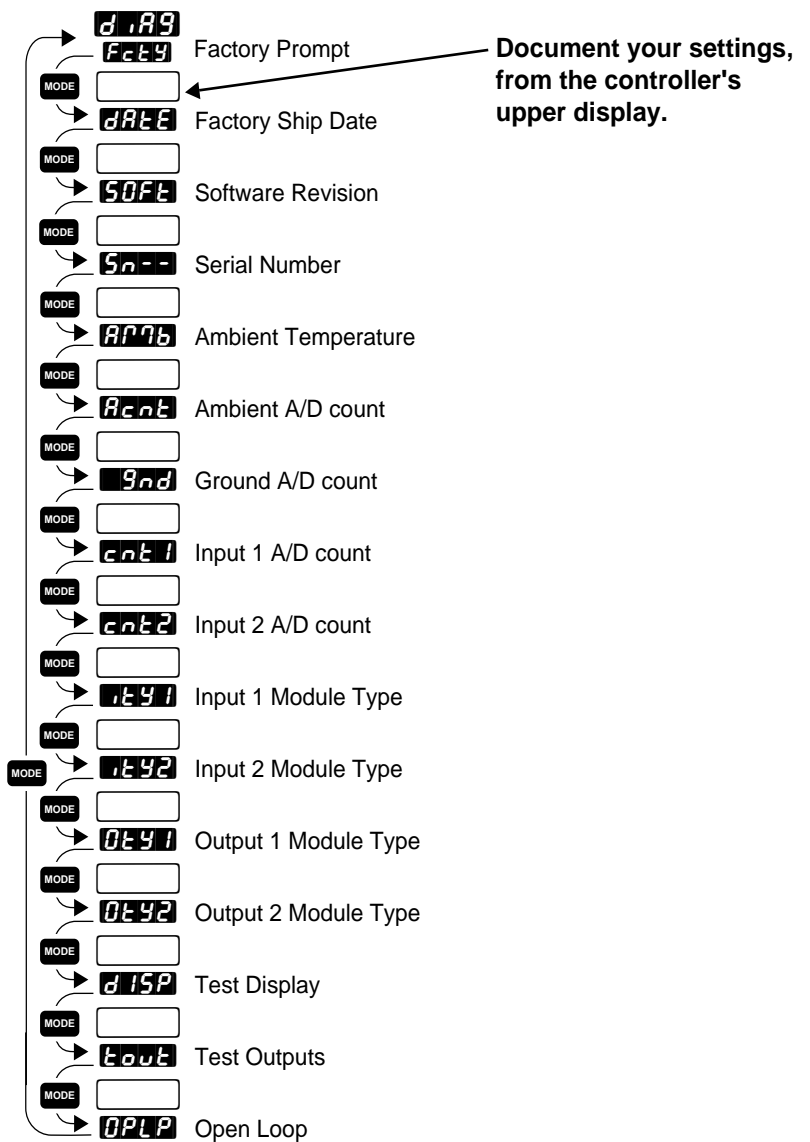

Figure 6.1
The Diagnostics Menu

Factory-Diagnostics

A four-digit LED display showing the text "DATE" in a monospace font.

Factory Ship Date

Shows the date that the final factory control test was performed. The first two digits represent the week as numbered from **01** to **52**. The second two digits represent the year **97**, **98**, etc...

DATE This prompt always appears.

A four-digit LED display showing the text "SOFT" in a monospace font.

Software Revision

Shows the controller's software revision code. This letter indicates the software revision of your controller; **50 d**.

SOFT This prompt always appears.

A four-digit LED display showing "Sn--" in a monospace font.

Serial Number

Shows the controller's serial number. The first two letters in the upper display are to indicate that the controller is in serial number mode. The right half of the upper display shows the first two digits of the serial number. The lower display shows the last four digits of the serial number.

Two examples of serial number displays. The first shows "Sn34" on the top line and "5678" on the bottom line. The second shows "Sn78" on the top line and "5678" on the bottom line.

This is what the controller with the serial number 0988345678 would display.

Sn This prompt always appears.

A four-digit LED display showing "AP76" in a monospace font.

Ambient Temperature

Shows the ambient temperature at the Input 1 terminals. The temperature is shown in °F in the form **0000** regardless of the settings of **DEC 1**, **DEC 2**, **dFL**, or **C.F**.

AP76 This prompt always appears.

A four-digit LED display showing "Acnt" in a monospace font.A four-digit LED display showing "9nd" in a monospace font.A four-digit LED display showing "cnt 1" in a monospace font.A four-digit LED display showing "cnt 2" in a monospace font.

Factory Use Only

These prompts are used only at the factory.

Acnt **9nd** **cnt 1** **cnt 2** These prompts always appear.



Inputs 1 and 2 Module Types

Displays which input module is installed in the controller. Please document this value before contacting the factory for technical assistance.

Input Types

- **nonE** No input module
- **tc** Thermocouple only module
- **UOFF** Universal off
- **URtd** Universal rtd
- **UtcH** Universal high-gain thermocouple
- **UtcL** Universal low-gain thermocouple
- **UPmV** Universal millivolts
- **UPrc** Universal process

1E41 1E42 These prompts always appear.

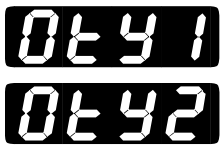

Outputs 1 and 2 Module Types

Displays which output module is installed in the controller. Please document this value before contacting the factory for technical assistance.



Output Types

- **nonE** no output module
- **SSr1** 0.5A solid-state relay
- **SSIS** 0.5A solid-state relay with suppression
- **dc** switched DC output
- **rlcs** form C relay with suppression
- **Proc** process output (Output 1 only)

0E41 0E42 These prompts always appear.



Test Displays

Runs a brief test of the controller's displays and LEDs. To run the test, scroll through the Diagnostics Menu until **d.5P** is shown in the lower display. Use the Up-arrow key  or Down-arrow key  to select **YES** from the upper display and press the mode key **MODE**.

The controller will run pattern tests, blink all the LEDs on and off, and end with the model number in both displays.

d.5P This prompt always appears.



Default
↓



Factory-Diagnostics

tout

Test Outputs

This prompt tests each output. To run the test, scroll through the Diagnostics Menu until [tout] is shown in the lower display. Use the Up-arrow key  or Down-arrow key  to select an output **out1** or **out2**. The LED for that output should light after a second or two indicating that the output has been successfully energized. Do not press the mode key **MODE** to activate the test; it starts automatically when anything other than **OFF** is selected.

If any of the LEDs fail to light contact the factory.

tout This prompt always appears.

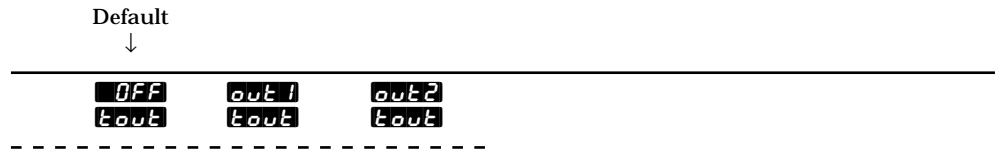

OPLP

Open Loop

Checks the control loop, consisting of the controller output, power control, heater and sensor. With open loop enabled, the controller monitors the output power level and checks for a change in the process input value. If the output power is at maximum for a period of time equal to the reset time and the process input has not changed by at least $\pm 5^{\circ}\text{F}$, the controller will switch to manual mode at 0% output power and **OPLP** will be displayed in the lower display.

To clear this error, enter the Setup Menu and press the display key **DISPLAY**. To get back into auto mode, press the Auto/Man key **AUTO/MAN**.

OPLP This prompt always appears.

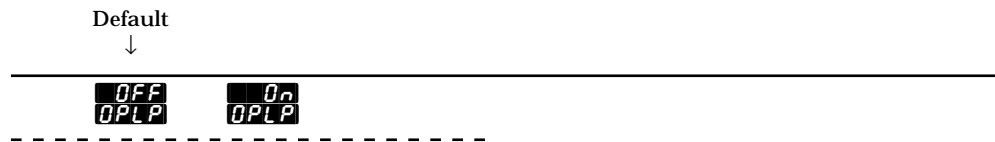

Factory-Calibration

Reaching the Calibration Menu

- Press the Up-arrow and Down-arrow keys together and hold until the **LOC** prompt appears in the lower display. Press and hold again until the **Fcty** prompt appears in the lower display.
- Use the Up-arrow key to select the Calibration Menu **CAL** in the upper display.

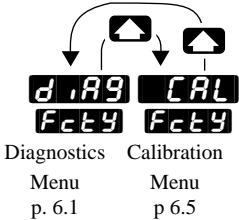

- Press the Mode key **MODE** to step through the prompts.

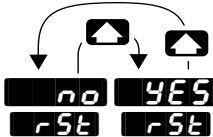

- Press the Up-arrow key or the Down-arrow key to select one of the prompt values.

Refer to *Calibrating Watlow Process Controls* for information about the Calibration Menu.



CAUTION:
Before attempting to calibrate, make sure you have the proper equipment called for in each procedure. The Series 988LF is calibrated and tested before it leaves the factory. Attempting to calibrate the controller without the proper equipment could result in damage to property and/or equipment.

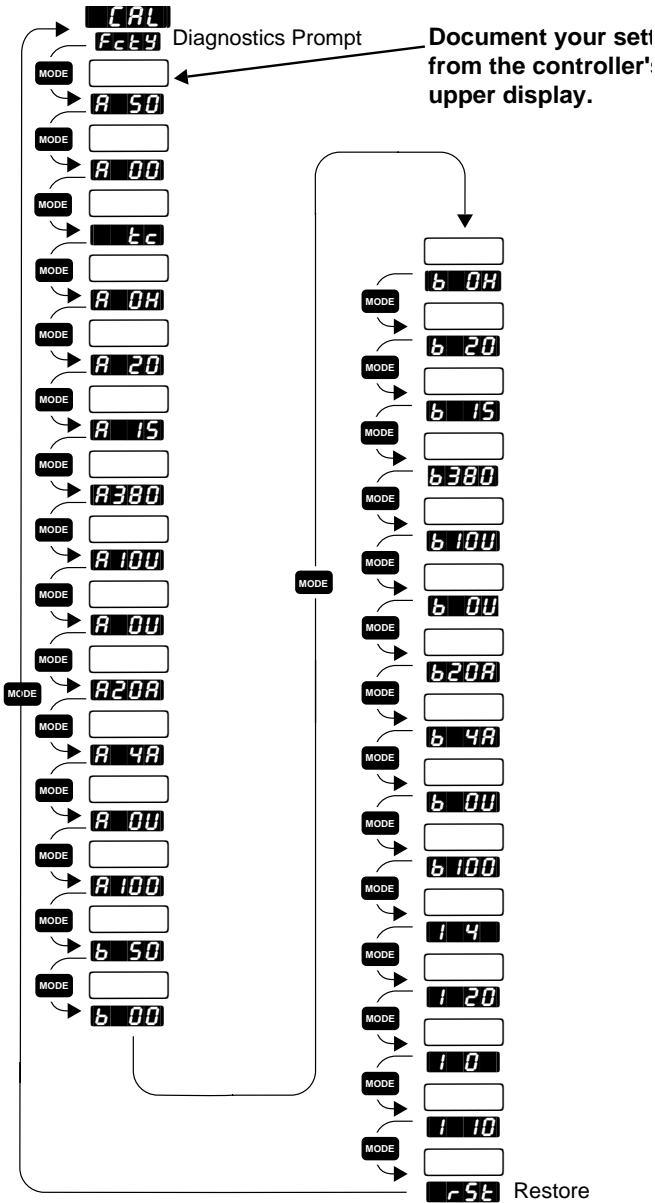

Figure 6.5 - The Calibration Menu



Restore

Restores the original factory calibration values. This is a simple way to recover from a mistake made while calibrating the controller.

rSt This prompt always appears.

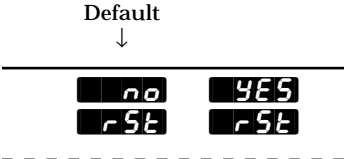

Notes

Chapter 7 Tuning, Manual Operation, Alarms and Error Codes

Auto-tuning (Heat and/or Cool)

NOTE:
A useful reference on tuning is *Tuning of Industrial Control Systems* by Armando B. Corripio, published by the Instrument Society of America.

The Series 988LF can automatically tune the PID parameters to fit the characteristics of your particular thermal system.

Once the auto-tune sequence has begun, all PID values for both heat and cool are set to **0.0** and the control goes into an on/off mode of control at 90% of the established set point. The displayed set point remains unchanged.

Auto-tuning at a set point of 200°F

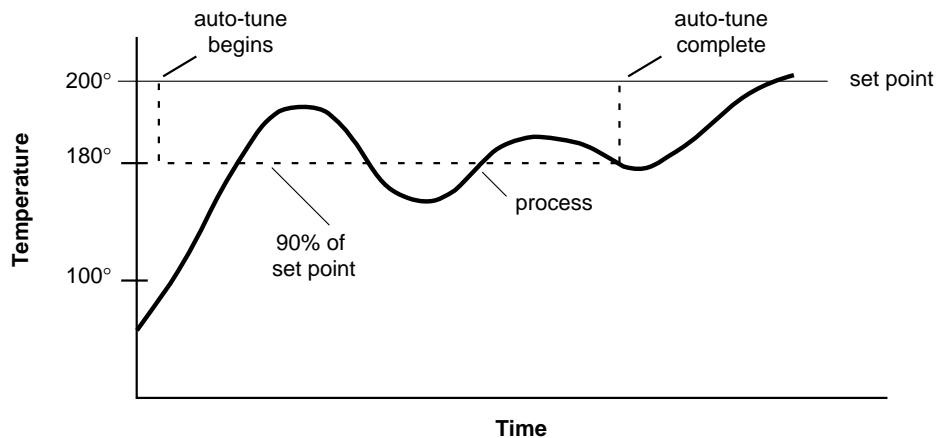

Figure 7.1 - Auto-tuning example



CAUTION:
If a mechanical relay or contactor is switching power to the load, a longer cycle time may be desirable to minimize wear on the mechanical components. The typical life of a mechanical relay is 100,000 cycles. Verify that the cycle time selected is appropriate for the output device type. Failure to do so could result in damage to equipment and/or property.

When the control finishes “learning” the system, it resumes standard PID control using the PID values established by the auto-tuning process. Changing the set point during an auto-tune restarts the auto-tune procedure.

During auto-tuning the process must cross the set point four times within an 80-minute time span for the Series 988LF to successfully complete the auto-tune. If this does not happen within the 80-minute time limit, the Series 988LF chooses PID values based on the 80-minute tuning cycle performed.

To start auto-tuning:

1. **Press the Mode key** **MODE** to advance through the Operations menu until the **AUT** prompt appears in the lower display.
2. **Use the Up-arrow** **▲** or **Down-arrow** **▼** key to select **On** or **OFF**.
3. **Press the Display key** **DISPLAY**. While the control is in the tuning mode the lower display alternates every second between the normal information and the **tunE** prompt.

Tuning

4. **When tuning is complete**, the displays return to their previous state and **AUT** reverts to **OFF**. The Series 988LF installs the PID tuning parameters it has calculated and saves them in non-volatile memory.

To abort auto-tuning either reset the **AUT** prompt to off, press the Auto/Man key **AUTO** twice, or cycle power off and on. In all cases, aborting auto-tune restores all values to their state before auto-tuning began.

Manual Tuning

For optimum control performance, tune the Series 988LF to your thermal system. The tuning settings here are for a broad spectrum of applications; your system may have somewhat different requirements. NOTE: This is a slow procedure that may take hours to obtain optimum values.

NOTE:

Tune heating outputs at a set point above the ambient process value.
Tune cooling outputs at a set point below the ambient process value.

1. Apply power to the Series 988LF and enter a set point. Begin with **Pb** set to **1**; **rE** or **It** set to **000**; **rA** or **dE** set to **000**; **Et** set to **50**; **CAL** set to **0**; and **AUT** set to **OFF**.
2. Proportional Band Adjustment: Gradually increase **Pb** until the upper display process value stabilizes at a constant value. The process value will not be right on set point because the initial reset value is 0.00 repeats per minute. (If **Pb** is set to **0** then **rE**, **It**, **rA** and **dE** are inoperative, and the Series 988 functions as a simple on/off control.) The **HYS** prompt determines the switching differential value.
3. Reset/Integral Adjustment: Gradually increase **rE** or **It** until the upper display process value begins to oscillate or "hunt." Then slowly decrease **rE** or **It** until the upper display stabilizes again near set point.
4. Cycle Time Adjustment: Set **Et** as required. Faster cycle times sometimes achieve the best system control. However, if a mechanical contactor or solenoid is switching power to the load, a longer cycle time may be desirable to minimize wear on the mechanical components. Experiment until the cycle time is consistent with the quality of control you want. **Et** will not appear on units with a process output (98__-__F-__ or 98__-__F-__).
5. Rate/Derivative Adjustment: Increase **rA** or **dE** to 0.10 minute. Then raise set point by 20° to 30°F, or 11° to 17°C. Observe the system's approach to the set point. If the load process value overshoots the set point, increase **rA** or **dE** to 0.50 minutes.

Raise the set point by 20° to 30°F, or 11° to 17°C and watch the approach to the new set point. If you increase **SP** or **DE** too much, the approach to set point will be very sluggish. Repeat as necessary until the system rises to the new set point without overshooting or approaching the set point too slowly.

6. Calibration Offset Adjustment: You may want your system to control to a process value other than the value coming from the input sensor. If so, measure the difference between that process value (perhaps at another point in the system) and the process value showing in the upper display. Then enter the **CAL** offset value you want. Calibration offset adds or subtracts degrees from the value of the input signal.

Manual and Automatic Operation

To change from auto to manual operation, press the Auto/Man key **AUTO/**
MAN twice.

Manual operation provides open-loop control of the outputs from a range of -100% to 100% output. The Series 988LF allows a negative output value only when **0E1** or **0E2** (Output Menu) is set to **CL** (cool). Automatic operation provides closed-loop on/off or PID control. When the operator transfers from a closed loop to an open loop, the Series 988LF retains the power level from the closed loop control. When the Series 988LF returns to closed-loop control, it restores the previous set-point value.

The Auto/Man LED (located on the Auto/Man key **AUTO/**
MAN) indicates whether the controller is in automatic or manual operation. When the LED is lit, the control is in manual operation. When the LED is off, it is in automatic operation. When the LED flashes, press the key again within five seconds to complete the change in operation.

When a sensor opens, the controller switches from automatic to manual operation.

- If the process has stabilized at a power level less than 75% ($\pm 5\%$) for a two-minute period prior to the sensor break, then the Series 988LF switches to manual operation at the last automatic power level. If these conditions are not met, the output goes to 0% power (output disabled).

When transferring from automatic to manual operation, the control output, or outputs, remain stable — a bumpless, or smooth, transition. When transferring from automatic to manual operation, the output value appears in the lower display. In automatic operation, the set point appears.

Using Alarms

Output 2 of the Series 988LF can function as an alarm. This is accomplished with the **OL2** prompt (Setup Menu). If **AL** is selected, the output is energized in the non-alarm condition and de-energizes the output in the alarm condition. Selecting **ALn** reverses this action: de-energizing the output in a non-alarm condition and energizing it in an alarm condition.

If the L2 LED on the front panel is lit, this indicates an alarm condition for output 2.

Once you've configured **OL2** as an alarm, select the **AL** prompt. At this prompt, you can select the type of alarm: process or deviation.

A **process alarm** sets an absolute temperature range or process value range. When the temperature or process leaves the range an alarm occurs. A process alarm is not tied to the set point.

Example: If your set point is 100°F and a process alarm high limit is set to 150°F and the low limit is set to 50°F, the high limit trips at 150°F, and the low alarm at 50°F. If you change the set point, the process alarm limits remain the same.

A **deviation alarm** alerts the operator when the process strays too far from the set point. The operator can enter independent high and low alarm settings. The reference for the deviation alarm is the set point. Any change in set point causes a corresponding shift in the deviation alarm. Low alarms are usually set at a negative deviation while high alarms are a positive deviation.

Example: If your set point is 100°F, a deviation alarm high limit is set to +7°F and the low limit is set to -5°F, then the high alarm trips at 107°F, and the low alarm at 95°F. If you change the set point to 130°F, the alarms follow the set point and trip at 137°F and 125°F.

Alarms can be latching or non-latching. When the alarm condition is removed, a non-latching alarm automatically clears the alarm output and alarm message, if one is present. You must manually clear a latching alarm before it will disappear.

The alarm output is indicated by the corresponding LED on the front panel: L2. There may be an alarm message flashing in the lower display. When an alarm message is displayed, it alternately flashes with the current prompt at a one-second interval in the lower display.

To clear a latching alarm, first correct the condition then press the Auto/Man key **AUTO/****MAN** once.

Alarm silencing is available with all alarms. This function overrides the alarm on initial power up. On power up, the alarm message will not appear and the L2 LED and output will reflect a non-alarm condition. Silencing is active until the process has entered the safe region located between the low- and high-alarm settings. Then deviation outside this safe zone triggers an alarm. If an alarm occurs at this point, the output can be silenced by pressing the Auto/Man key **AUTO/****MAN** once, but the controller still displays the alarm message.

NOTE:
An alarm display will be masked by an error condition or when the control is in the Calibration or Setup menus.

Error Code E1 and E2 Messages

Four dashes, **----**, in the upper display indicate a Series 988LF error. If the control was operating with stable output values (less than 75% power and less than a 5% changeover the past 2 minutes) when the error occurred, it continues to operate at those levels on a percent-power basis (**6PL5**). If output values were not stable, or the percent output was greater than 75%, the control outputs drop to 0% power (off).

NOTE:

To view the error code, press the Auto/Man key **AUTO MAN** once. The upper display shows the error code for five seconds before returning to the **----** display.

E1 1 E2 1: A/D underflow error

The analog-to-digital (A/D) converter of the input indicated by the first number is under range. An open or reversed polarity sensor is the most likely cause. Check the sensor. Make sure the input prompt is set to the correct sensor.

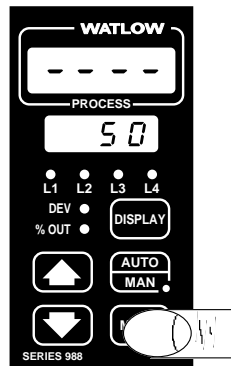

Figure 7.5 - Error Code Display

E1 2 E2 2: Sensor under-range error

The sensor at the input indicated by the first number generated a value lower than that allowed for the range of the sensor, or the analog-to-digital (A/D) converter malfunctioned. Make sure the setting for the input (Setup Menu) matches the sensor type and that the sensor range falls within the range of the process being controlled.

E1 3 E2 3: Sensor over-range error

The sensor at the input indicated by the first number generated a value higher than that allowed for the range of the sensor, or the analog-to-digital (A/D) converter malfunctioned. Make sure the setting for the input (Setup Menu) matches the sensor type and that the sensor range falls within the range of the process being controlled.

NOTE:

An alarm display will be masked by an error condition or when the control is in the Calibration or Setup menus.

E1 4 E2 4: A/D overflow error

The analog-to-digital (A/D) converter at the input indicated by the first number is over range. An open or reversed polarity sensor is the most likely cause. Check the sensor. Make sure the input (Setup Menu) is set to the correct sensor type.

The analog-to-digital (A/D) converter input voltage may be too high to convert an A/D signal.

E r 3: Ambient temperature error

Error Codes

The ambient temperature of the Series 988LF has dropped below 32°F/0°C or risen above 149°F/65°C. Calibration errors can also cause this error code. Try setting **Er5t** (Calibration Menu) to **4E5**.

Er4: RAM verification error

An internal RAM failure has occurred. Contact the factory.

Er5: Non-volatile checksum error

An EEPROM checksum error was detected. Turn the power off then back on again. If this does not clear the error, contact the factory.

OpLp: Open-loop detect

This error is not available while in the on/off mode. It is only active when **OpLp** is set to **On** (Diagnostics Menu).

Er9: Configuration error

An incorrect module has been installed in the control. Contact the factory.

Error Code Actions

- All of the above error codes except **Er4**, **Er5** and **Er9** will result in this condition:
 - If the control was operating with stable output values (less than 75% power and less than a 5% changeover the past 2 minutes) when the error occurred, it continues to operate at those levels on a percent-power basis (**bPL5**). If output values were not stable, or the percent output was greater than 75%, the control outputs drop to 0% power (off).
- To clear an error code...
 - If **Err** is set to **nLA**, the error code should clear once the problem is corrected.
 - If **Err** is set to **LAe**, correct the problem and cycle power. You can also clear the error by pressing both the Up-arrow **▲** and Down-arrow **▼** keys to enter the Setup Menu, then press the Display key **DISPLAY**.
- Error codes **Er4**, **Er5** and **Er9** will result in these conditions:
 - The control is in automatic operation with both control outputs off.
 - The alarm outputs are in their alarm state (de-energized with the LED lit).
 - The lower display is blank.
 - The upper display indicates the error code.
 - All keys are inactive.
 - With **Er5**, all Setup Menu prompts return to default values.

NOTE:

An alarm display will be masked by an error condition or when the control is in the Calibration or Setup menus.

Cycle power to the control. If the error is still present contact the factory.

Notes

Appendix

Warranty and Returns	A.1
Glossary	A.2
Index	A.4
Specifications	A.6
Model Number	A.7
Menu Overview	A.8
Declaration of Conformity	A.9



Warranty

The Watlow Series 988LF is warranted to be free of defects in material and workmanship for 36 months after delivery to the first purchaser for use, providing that the units have not been misapplied. Since Watlow has no control over their use, and sometimes misuse, we cannot guarantee against failure. Watlow's obligations hereunder, at Watlow's option, are limited to replacement, repair or refund of purchase price, and parts which upon examination prove to be defective within the warranty period specified. This warranty does not apply to damage resulting from transportation, alteration, misuse or abuse.

Watlow Controls

Watlow Controls is a division of Watlow Electric Manufacturing Company, St. Louis, Missouri, a manufacturer of industrial electric heating products since 1922. Watlow begins with a full set of specifications and completes an industrial product that is manufactured totally in-house, in the U.S.A. Watlow products include electric heaters, sensors, controls and switching devices. The Winona operation has been designing solid state electronic control devices since 1962, and has earned the reputation as an excellent supplier to original equipment manufacturers. These OEMs depend upon Watlow Controls to provide compatibly engineered controls which they can incorporate into their products with confidence. Watlow Controls resides in a 100,000-square-foot marketing, engineering and manufacturing facility in Winona, Minnesota.

Returns

1. Call Watlow Customer Service, (507) 454-5300, for a Return Material Authorization (RMA) number before returning any item for repair. We need this information:
 - Ship to address
 - Contact name
 - Ship via
 - Symptoms and/or special instructions
 - Name and phone number of person returning the material.
 - Bill to address
 - Phone number
 - Your P.O. number

NOTE: All unit model number stemming from this user's manual end in "-INT," which indicates a CE compliant product.

2. Prior approval and an RMA number, from the Customer Service Department, is needed when returning any unused product for credit. Make sure the RMA number is on the outside of the carton, and on all paperwork returned. Ship on a Freight Prepaid basis.
3. After we receive your return, we will examine it and determine the cause for your action.
4. In cases of manufacturing defect, we will enter a repair order, replacement order, or issue credit for material. A 20-percent restocking charge is applied for all returned stock controls and accessories.
5. If the unit is unrepairable, it will be returned to you with a letter of explanation. Repair costs will not exceed 50 percent of the original cost.

Shipping Claims

When you receive your Watlow control, examine the package for any signs of external damage it may have sustained enroute. If there is apparent damage either outside the box or to its contents, make a claim with the shipper immediately. Save the original shipping carton and packing material.

Glossary

annunciator — A visual display that uses pilot lights to indicate the former or existing condition of several items in a system.

bumpless transfer — A smooth transition from auto (closed loop) to manual (open loop) operation. The control output(s) does not change during the transfer.

burst fire — A power control method that repeatedly turns on and off full AC cycles. Also called zero-cross fire, it switches close to the zero-voltage point of the AC sine wave. Variable-time-base burst fire selectively holds or transits AC cycles to achieve the desired power level.

calibration offset — An adjustment to eliminate the difference between the indicated value and the actual process value.

cascade — Control algorithm in which the output of one control loop provides the set point for another loop. The second loop, in turn, determines the control action.

closed loop — A control system that uses a sensor to measure a process variable and makes decisions based on that feedback.

cold junction — See junction, cold.

cold junction compensation — Electronic means to compensate for the effective temperature at the cold junction.

current transformer — A transformer designed for measuring electrical current.

dead band — The range through which a variation of the input produces no noticeable change in the output. In the dead band, specific conditions can be placed on control output actions. Operators select the dead band. It is usually above the heating proportional band and below the cooling proportional band.

default parameters — The programmed instructions that are permanently stored in the microprocessor software.

derivative — The rate of change in a process variable. Also known as rate. See PID.

DIN (Deutsche Industrial Norm) — A set of technical, scientific and dimensional standards developed in Germany. Many DIN standards have worldwide recognition.

DIN-a-mite — Watlow family of SCR power controls.

droop — In proportional controllers, the difference between set point and actual value after the system stabilizes.

duty cycle — The percentage of a cycle time in which the output is on.

external signal conditioner power supply — A dc voltage source that powers external devices.

filter —
digital filter (DF) — A filter that slows the response of a system when inputs change unrealistically or too fast. Equivalent to a standard resistor-capacitor (RC) filter.

digital adaptive filter — A filter that rejects high frequency input signal noise (noise spikes).

heat/cool output filter — A filter that slows the change in the response of the heat or cool output. The output responds to a step change by going to approximately 2/3 its final value within the number of scans that are set.

form A — A single-pole, single-throw relay that uses only the normally open (NO) and common contacts. These contacts close when the relay coil is energized. They open when power is removed from the coil.

form B — A single-pole, single-throw relay that uses only the normally closed (NC) and common contacts. These contacts open when the relay coil is energized. They close when power is removed from the coil.

form C — A single-pole, double-throw relay that uses the normally open (NO), normally closed (NC) and common contacts. The operator can choose to wire for a Form A or Form B contact.

hunting — Oscillation of process temperature between the set point and the process variable.

hysteresis — A change in the process variable required to re-energize the control or alarm output. Sometimes called switching differential.

integral — Control action that automatically eliminates offset, or droop, between set point and actual process temperature. See reset, automatic.

isolation — Electrical separation of sensor from high voltage circuitry. Allows use of grounded or ungrounded sensing element.

JIS (Joint Industrial Standards) — A Japanese agency that establishes and maintains standards for equipment and components. Also known as JISC (Japanese Industrial Standards Committee), its function is similar to Germany's Deutsche Industrial Norm (DIN).

junction — The point where two dissimilar metal conductors join to form a thermocouple.

cold junction — Connection point between thermocouple metals and the electronic instrument. See reference junction.

grounded junction — Type of thermocouple probe in which the hot, or measuring junction, is an integral part of the sheath material. No electrical isolation is provided.

isolated junction — A form of thermocouple probe construction in which the measuring junction is fully enclosed in a protective sheath and electrically isolated from it. Commonly called an ungrounded junction.

reference junction — The junction in a thermocouple circuit held at a stable, known temperature (cold junction). Standard reference temperature is 32°F (0°C).

thermocouple junction — The point where the two dissimilar metal conductors join. In a typical thermocouple circuit, there is a measuring junction and a reference junction. See reference junction.

ungrounded junction — See isolated junction.

linearization, square root — The extraction of a linear signal from a nonlinear signal corresponding to the measured flow from a flow transmitter. Also called square root extraction.

NEMA 4X — A NEMA specification for determining resistance to moisture infiltration. This rating certifies the controller as washable and corrosion resistant.

on/off — A method of control that turns the output full on until set point is reached, and then off until the process error exceeds the hysteresis.

open loop — A control system with no sensory feedback.

output — Control signal action in response to the difference between set point and process variable.

overshoot — The amount by which a process variable exceeds the set point before it stabilizes.

P control — Proportioning control.

PD control — Proportioning control with derivative (rate) action.

PDR control — Proportional derivative control with manual reset, used in fast responding systems where the reset causes instabilities. With PDR control, an operator can enter a manual reset value that eliminates droop in the system.

PI control — Proportioning control with integral (automatic reset) action.

PID — Proportional, integral, derivative. A control mode with three functions: proportional action dampens the system response, integral corrects for droop, and derivative prevents overshoot and undershoot.

process variable — The parameter that is controlled or measured. Typical examples are temperature, relative humidity, pressure, flow, fluid level, events, etc. The high process variable is the highest value of the process range, expressed in engineering units. The low process variable is the lowest value of the process range.

proportional band (PB) — A range in which the proportioning function of the control is active. Expressed in units, degrees or percent of span. See PID.

proportional control — A control using only the P (proportional) value of PID control.

rate band — A range in which the rate function of a controller is active. Expressed in multiples of the proportional band. See PID.

ratio — A method by which the controller measures the flow of an uncontrolled variable and uses a proportion of it to control the flow of a second variable.

reference junction — See junction.

reset — Control action that automatically eliminates offset, or droop, between set point and actual process temperature. Also see integral.

automatic reset — The integral function of a PI or PID temperature controller that adjusts the process temperature to the set point after the system stabilizes. The inverse of integral.

automatic power reset — A feature in latching limit controls that does not recognize power outage as a limit condition. When power is restored, the output is re-energized automatically, as long as the temperature is within limits.

manual reset — 1) A feature on a limit control that requires human intervention to return the limit to normal operation after a limit condition has occurred. 2) The adjustment of a proportional control to raise the proportional band to compensate for droop.

no key reset — A method for resetting the controller's memory (for instance, after an EPROM change).

resistance temperature detector (RTD) — A sensor that uses the resistance temperature characteristic to measure temperature. There are two basic types of RTDs: the wire RTD, which is usually made of platinum, and the thermistor, which is made of a semiconductor material. The wire RTD is a positive temperature coefficient sensor only, while the thermistor can have either a negative or positive temperature coefficient.

retransmit output — An analog output signal that may be scaled to represent the process value or set point value.

RTD — See resistance temperature detector.

slidewire feedback — A method of controlling the position of a valve. It uses a potentiometer to vary resistance () and indicate position of the valve.

switching sensitivity — In on/off control, the temperature change necessary to change the output from full on to full off. See hysteresis.

thermal system — A regulated environment that consists of a heat source, heat transfer medium or load, sensing device and a control instrument.

thermocouple (t/c) — A temperature sensing device made by joining two dissimilar metals. This junction produces an electrical voltage in proportion to the difference in temperature between the hot junction (sensing junction) and the leadwire connection to the instrument (cold junction).

thermocouple break protection — The ability of a control to detect a break in the thermocouple circuit and take a predetermined action.

three-mode control — Proportioning control with integral (reset) and derivative (rate). Also see PID.

time proportioning control — A method of controlling power by varying the on/off duty cycle of an output. This variance is proportional to the difference between the set point and the actual process temperature.

zero cross — Action that provides output switching only at or near the zero-voltage crossing points of the AC sine wave. See burst fire.

zero switching — See zero cross.

Index

%OUT LED 3.1
0-5V \approx (dc) process wiring
 input 1 2.7
 remote set point option 2.8
 output 1 2.9
0-10V \approx (dc) process wiring
 input 1 2.7
 remote set point option 2.8
 output 1 2.9
0-20mA process wiring
 input 1 2.7
 remote set point option 2.8
 output 1 2.9
0-50mV (high impedance) wiring
 input 1 2.7
 remote set point option 2.8
1-5V \approx (dc) process wiring
 input 1 2.7
 remote set point option 2.8
 output 1 2.9
4-20mA process wiring
 input 1 2.7
 remote set point option 2.8
 output 1 2.9

A

access to panel back 2.2
AC output wiring
 output 1 2.9
 output 2 2.10
alarm
 deviation 7.4
 process 7.4
alarm display, masked 7.5
alarm high 5.6
alarm low 5.6
alarms 7.4 - 7.5
alarms, latching 7.4
alarms, non-latching 7.4
alarm silencing 7.4
ambient temperature 6.2
annunciator A.2
Auto/Manual key 3.1, 7.3
Auto/Manual LED 3.1, 7.3
auto/manual operation 7.3
automatic operation 7.3
auto-tune 5.7
auto-tuning 7.1

B

brackets 2.1 - 2.2
bumpless transfer 7.3

C

Calibration Menu 6.5
calibration offset A.2
cautions iii
clearing error codes 7.6
closed loop A.2
cold junction A.2
consumer feedback iii
controller chassis, removing 1.1
current transformer A.2
cycle time
 output 1 5.3
 output 2 5.5

D

date 6.2
dead band 5.5
decimal 4.6
decimal point, location of 4.2
default A.2
derivative A.2
deviation alarm 7.4
DEV LED (set point deviation) 3.1

Diagnostics Menu 6.1 - 6.4
dimensions 2.1
DIN A.2
DIP switch functions 1.1 - 1.3
DIP switch locations 1.1 - 1.3
DIP switch setting
 input 1.2
 lockout 1.3
 display 6.3
Display Key 3.1
Display Loop 3.2
displays 3.1
documentation, maintaining ii, 6.3
Down-arrow Key 3.1
droop A.2
dual in-line package (DIP) switches 1.1 - 1.3
duty cycle A.2

E

error code messages 7.5 - 7.6
error code results 7.6
error codes, clearing 7.6
external signal conditioner
 power supply A.2

F

Factory Menus 6.1 - 6.5
factory ship date 6.2
feedback iii
form A A.2
form B A.2
form C A.2
front panel 3.1
front panel lockout 4.2

G

Glossary A.2 - A.3
ground loops 2.3

H, I

Input 1 4.3
input 1 wiring 2.7
 0-5V \approx (dc) process 2.7
 0-10V \approx (dc) process 2.7
 0-20mA process 2.4, 2.7
 0-50mV (high impedance) 2.7
 1-5V \approx (dc) process 2.7
 4-20mA process 2.4, 2.7
 RTD (2- or 3-wire) 2.7
 thermocouple 2.7
input DIP switches 1.2
 0-5V 1.2
 0-10V 1.2
 0-20mA 1.2
 0-50mV 1.2
 0-50mV (high impedance) 1.2
 1-5 1.2
 4-20mA 1.2
 RTD 1.2
 thermocouple 1.2
input module 6.3
input ranges (tables)
 input 1 4.4 - 4.5
 remote set point option 4.7 - 4.8
input-to-output isolation 2.3
installation 2.1 - 2.2
integral A.2
isolation 2.3, A.2

J

JIS A.2
junctions A.2

K

keys 3.1

L

L1 (output 1) 3.1
L2 (output 2) 3.1
latching alarm 7.3
linearization A.2
local-remote 5.7
locating DIP switches 1.1 - 1.3
Lockout 4.2
lockout DIP switch 1.3
lockout level, setting 4.2
lower display 3.1

M

maintaining documentation ii, 6.3
manual operation 7.2
manual tuning 7.2
mechanical relay 7.1
menu lockout 4.2
Mode Key 3.1
model number ii, iii, A.7
module types 6.3
mounting 2.1 - 2.2

N

National Electric Code (NEC) 2.3, 2.5, 2.6
NEMA 4X seal 2.2, A.2
non-latching alarm 7.4
notes iii

O

on/off control A.2
Operation Menu 5.1 - 5.7
open loop 6.4, A.2
ordering information A.7
output A.2
 output 1 4.9
 output 1 wiring 2.9
 0-5V \approx (dc) process 2.9
 0-10V \approx (dc) process 2.9
 0-20mA process 2.9
 1-5V \approx (dc) process 2.9
 4-20mA process 2.9
 AC outputs 2.9
 switched dc, open collector 2.9
 output 2 4.9
 output 2 wiring 2.10
 AC outputs 2.10
 switched dc, open collector 2.10
output configurations
 output 1 (control) 3.1
 output 2 (control or alarm) 3.1
output module types 6.3
overriding alarms 7.4
overshoot A.3

P

P control A.3
panel back access 2.2
panel cutouts 2.1 - 2.2
Panel Lockout Menu 4.2
PD control A.3
PDR control A.3
PI control A.3
PID control A.3
power wiring 2.3
process variable A.3
process alarm 7.4
proportional band A.3
 output 1 5.2
proportioning control A.3

Q, R

range high 1 4.4 - 4.5
 range high 2 4.7 - 4.8
 range low 1 4.4 - 4.5
 range low 2 4.7 - 4.8
 rate
 output 1 5.3
 output 2 5.4
 rate band A.3
 reference junction A.2
 relay, mechanical 7.1
 release tabs 1.1, 2.2
 remote set point 4.6
 removing controller chassis 1.1, 2.2
 reset
 output 1 5.3
 output 2 5.4
 restore 6.5
 retransmit A.3
 RTD A.3
 RTD calibration curve 4.5
 RTD input 2.3
 RTD wiring
 input 1 2.7
 remote set point option 2.8

S

safety practices 2.3, 2.5, 2.6
 sensor installation 2.3
 sensor type
 input 1 4.3
 serial number 6.2
 set point 2 5.2
 setting DIP switches 1.1 - 1.3
 input 1.2
 lockout 1.3
 Setup Menus 4.1 - 4.10
 shipping claims A.1
 silencing 4.10
 silencing alarms 7.3
 slidewire feedback A.3
 software revision 6.2
 specifications A.6
 square root extraction (linearization, square root) A.2
 switched dc, open collector wiring
 output 1 2.9
 output 2 2.10
 switching sensitivity A.3

T

technical assistance iii, 6.3
 temperature limit control protection 2.5
 terminal designation stickers 2.3
 test displays 6.3
 test output 6.4
 thermal system A.3
 thermocouple 2.3, A.3
 thermocouple break protection A.3
 thermocouple wiring
 input 1 2.7
 remote set point option 2.8
 three-mode control A.3
 time proportioning control A.3
 tuning
 automatic 7.1 - 7.2
 manual 7.2
 Tuning of Industrial Control Systems 7.1

U

Up-arrow Key 3.1
 upper display 3.1
 using manual ii - iii

V, W

warnings iii
 warranty A.1
 wiring 2.1, 2.3 - 2.10
 input 1 2.7
 input 2 2.8
 output 1 2.9
 output 2 2.10
 wiring example 2.5
 wiring safety 2.3, 2.5, 2.6

X, Y, Z

zero switching A.3

Prompt Index

---- (error) 7.5

A

Acnt (Ambient A/D count) 6.2
AH1 (alarm high) 5.6
AL0 (alarm low) 5.6
ALT (alarm type) 4.10
AP75 (ambient temperature) 6.2
AUT (auto-tune) 5.7

B

bPLS (bumpless transfer) 7.3, 7.5

C

C_F (Celsius_Fahrenheit) 4.8
CR0 (calibration offset) 5.7
CR1 (Calibration Menu) 6.5
CT1 (cycle time, output 1) 5.3
CT2 (cycle time, output 2) 5.5

D

DATE (factory ship date) 6.2
db (dead band) 5.5
DEC (decimal) 4.6
DFLT (default) 4.3
DIAG (Diagnostics Menu) 6.1
DISP (test displays) 6.3

E

E11 (A/D underflow error) 7.5
E21 (A/D underflow error) 7.5
E12 (sensor under-range error) 7.5
E22 (sensor under-range error) 7.5
E13 (sensor over-range error) 7.5
E23 (sensor over-range error) 7.5
E14 (A/D overflow error) 7.5
E24 (A/D overflow error) 7.5
Er3 (ambient temperature error) 7.6
Er4 (RAM identification error) 7.6
Er5 (non-volatile checksum error) 7.6
Er9 (configuration error) 7.6

F

Fcty (Factory Menues) 6.1

G, H, I

IN1 (input 1) 4.3
LY1 (input 1 module type) 6.3
LY2 (input 2 module type) 6.3

J, K, L

LRE (latching) 4.10
LOC (front panel lockout) 4.2
L-r (local-remote) 5.7

M, N, O

OPLP (open loop) 6.4, 7.6
OE1 (output 1) 4.9
OE2 (output 2) 4.9
OY1 (output 1 module type) 6.3
OY2 (output 2 module type) 6.3

P

Pb1 (proportional band, output 1) 5.2
Pb2 (proportional band, output 2) 5.4

Q, R

rA1 (rate, output 1) 5.3
rA2 (rate, output 2) 5.4
rE1 (reset, output 1, Pid A) 5.3
rE2 (reset, output 2, PID A) 5.4
rH1 (range high 1) 4.4 - 4.5
rH2 (range high 2) 4.7 - 4.8
rL1 (range low 1) 4.4 - 4.5
rL2 (range low 2) 4.7 - 4.8
rSP (remote set point) 4.6 - 4.7
rSE (restore) 6.5
rtd (RTD calibration curve) 4.5

S

SIL (silencing) 4.10
SN (serial number) 6.2
SRFE (software revision) 6.2
SP2 (set point 2) 5.2

T, U, V, W, X, Y, Z

TOUT (test outputs) 6.4

Specifications

(1064)

Line Voltage/Power

- 100-240V \approx (ac/dc) +10%, -15%; 50/60Hz, \pm 5%
- 24-28V \approx (ac/dc) +10%, -15%; 50/60Hz, \pm 5%
- Power consumption 16VA maximum

Operating Environment

- 32 to 149°F (0 to 65°C)
- 0 to 90% RH, non-condensing

Storage Temperature

- -40 to 185°F (-40 to 85°C).

Agency Approvals

- UL, C-UL File # 43684
- CE: 89/336/EEC Electromagnetic Compatibility Directive.
EN 50081-2: 1994 Emissions.
EN 50082-2: 1995 Immunity.
- 73/23/EEC Low-Voltage Directive.
EN 61010-1: 1993 Safety.
- NEMA 4X

Terminals

- #6 compression universal head screws (tighten to 5 inch/pounds maximum), accepts 20-14 gauge wire.

Accuracy

- Calibration accuracy and sensor conformity: \pm 0.1% of span, \pm 1 LSD, 77°F \pm 5°F (25°C \pm 3°C) ambient and rated line #voltage \pm 10%
- Accuracy span: 1000°F (540°C) minimum
- Temperature stability: \pm 0.2°F/°F (0.1°C/°C) change in ambient

Mechanical

- 1/8 DIN panel mount, NEMA 4X (IP65 equivalent) front panel
- Overall width x height x depth
- Horizontal; 4.03" x 2.18" x 4.74", (102 mm x 55 mm x 120 mm)
- Vertical; 2.18" x 4.03" x 4.74", (55 mm x 102 mm x 120 mm)
- Depth behind panel; 4.06"(103 mm)
- Weight less than or equal to 14.0 oz (0.40kg)

Input Range

Specified temperature ranges represent the controller's operational span.

Thermocouple

(Available with basic or universal signal conditioner)

Type C ²	32	to	4200°F	or	0	to	2316°C
Type D ²	32	to	4200°F	or	0	to	2316°C
Type E	-328	to	1470°F	or	-200	to	799°C
Type J	32	to	1500°F	or	0	to	816°C
Type K	-328	to	2500°F	or	-200	to	1371°C
Type N	32	to	2372°F	or	0	to	1300°C
Type T	-328	to	750°F	or	-200	to	399°C
Pt 2 ²	32	to	2543°F	or	0	to	1395°C

(Available with universal signal conditioner)

Type B	1598	to	3300°F	or	870	to	1816°C
Type R	32	to	3200°F	or	0	to	1760°C
Type S	32	to	3200°F	or	0	to	1760°C

RTD Resolution (DIN or JIS) (Avail. w/universal signal conditioner)

1° (DIN)	-328	to	1472°F	or	-200	to	800°C
1° (JIS)	-328	to	1166°F	or	-200	to	630°C
0.1° (DIN and JIS)	-99.9	to	999.9°F	or	-73.3	to	537.7°C

Process (Available with universal signal conditioner)

0-50mV \approx (dc)	-999	to	9999 units
0-5V \approx (dc)	-999	to	9999 units
1-5V \approx (dc)	-999	to	9999 units
0-10V \approx (dc)	-999	to	9999 units
0-20mA \approx (dc)	-999	to	9999 units
4-20mA \approx (dc)	-999	to	9999 units

Output Options

- Solid state relay, 0.5A @ 24V~ (ac) min., 253V~ (ac) max., opto isolated, burst fire. With or without contact suppression.
- Open collector, switched dc signal provides a minimum turn-on voltage of 3V \approx (dc) into a minimum 500 load; maximum on voltage not greater than 32V \approx (dc) into an infinite load, isolated.
- Electromechanical relay¹, Form C, 5A @ 120/240~ (ac), 6A @ 28V \approx (dc), 1/8 hp. @ 120V~ (ac) or 125VA @ 120V~ (ac). With or without contact suppression. Off-state output impedance with RC suppression is 20k .
- Process, 0-20mA (dc), 4-20mA (dc) into 800 maximum, 0-5V \approx (dc), 1-5V \approx (dc), or 0-10V \approx (dc) into 1k minimum ¹, reverse acting, isolated.

¹ Electromechanical relays are warranted for 100,000 closures only. Solid-state switching devices are recommended for applications requiring fast cycle times or extended service life.

² Not an ANSI symbol.

Ordering Information⁻⁽¹³¹⁹⁾

To order, complete the code number to the right with the information below:

	9 8	L	-	-	-	-	-	A A
Series 988LF = Single channel 1/8 DIN temperature /process controller, vertical or horizontal mount								
Hardware								
6	=	24-28V≈(ac/dc) vertical mounting						
7	=	24-28V≈(ac/dc) horizontal mounting						
8	=	100-240V≈(ac/dc) vertical mounting						
9	=	100-240V≈(ac/dc) horizontal mounting						
Software								
L	=	Standard						
#1 Input								
1	=	Basic thermocouple signal conditioner (excludes tc types B, R, and S, RTD, Process inputs)						
2	=	Universal signal conditioner (All inputs included - see Range Information)						
#2 Input								
0	=	None						
2	=	Universal signal conditioner (Remote Set Point)						
#1 Output								
B	=	Solid state relay, Form A, 0.5A, with RC suppression						
C	=	Switched dc or open collector, isolated						
D	=	Electromechanical relay ¹ , Form C, 5A, with RC suppression						
E	=	Electromechanical relay ¹ , Form C, 5A, without RC suppression						
F	=	Universal process. 0-5V≈(dc), 1-5V≈(dc), 0-10≈dc, 0-20mA≈(dc), 4-20mA≈(dc), isolated						
K	=	Solid state relay, Form A, 0.5A, without RC suppression						
#2 Output								
A	=	None						
B	=	Solid state relay, Form A, 0.5A, with RC suppression						
C	=	Switched dc or open collector, isolated						
D	=	Electromechanical relay ¹ , Form C, 5A, with RC suppression						
E	=	Electromechanical relay ¹ , Form C, 5A, without contact suppression						
K	=	Solid state relay, Form A, 0.5A, without contact suppression						
Display/Overlay								
GG	=	Green/Green display						
GR	=	Green/Red display						
RG	=	Red/Green display						
RR	=	Red/Red display						

¹Electromechanical relays warranted for 100,000 closures only. Solid state switching devices recommended for applications requiring fast cycle times or extended service life.

NOTE: User documentation may be available in French, German, Spanish, Italian and Dutch, as well as English. Check Watlow's website (www.watlow.com/) for availability. Specify language at time of order.

Menu Overview

Display Loop (Lower Display) Press **MODE** to exit any menu and reach the Display Loop at any time.

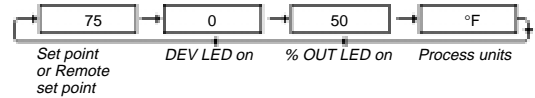

**Figure A.8-
The Series 988LF Map**

NOTE:
This is a complete listing of all Series 988LF prompts.

Not all prompts will appear on your control. They are dependent on your configuration and model number.

To Navigate:

Press **DISPLAY** to return to the Display Loop from any location and to advance through the Display Loop.

Press **UP** or **DOWN** to move between the menus.

Press **MODE** to advance through a menu.

Hold **MODE** while pressing **UP** to move backwards through the menus.

Press **UP** or **DOWN** to select prompt values.

Operation Menu Press **MODE** to advance to the Operation Menu.
Setup Menu Press **UP** and **DOWN** for 3 seconds to enter the Setup Menu.

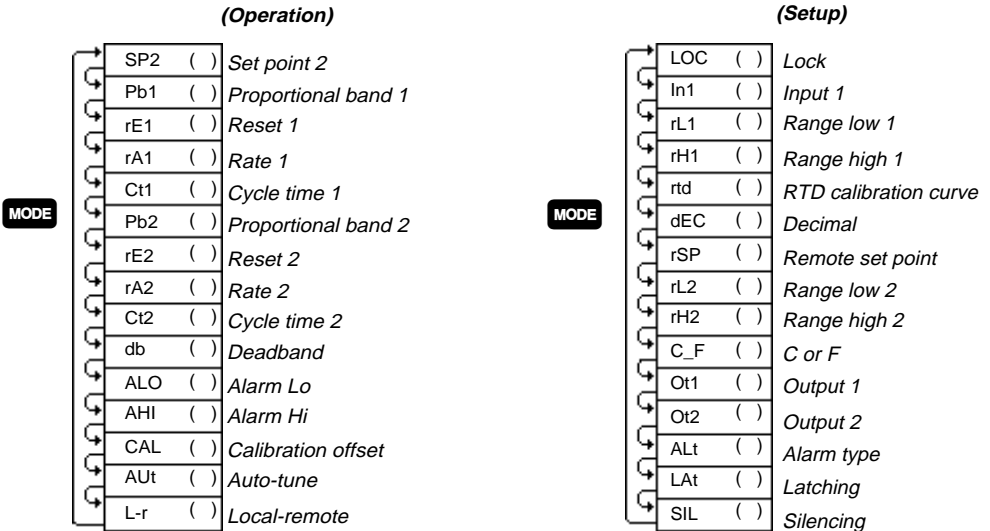

Factory Menus At the Setup Menu, press **UP** and **DOWN** another 3 seconds to enter the Factory Menus.

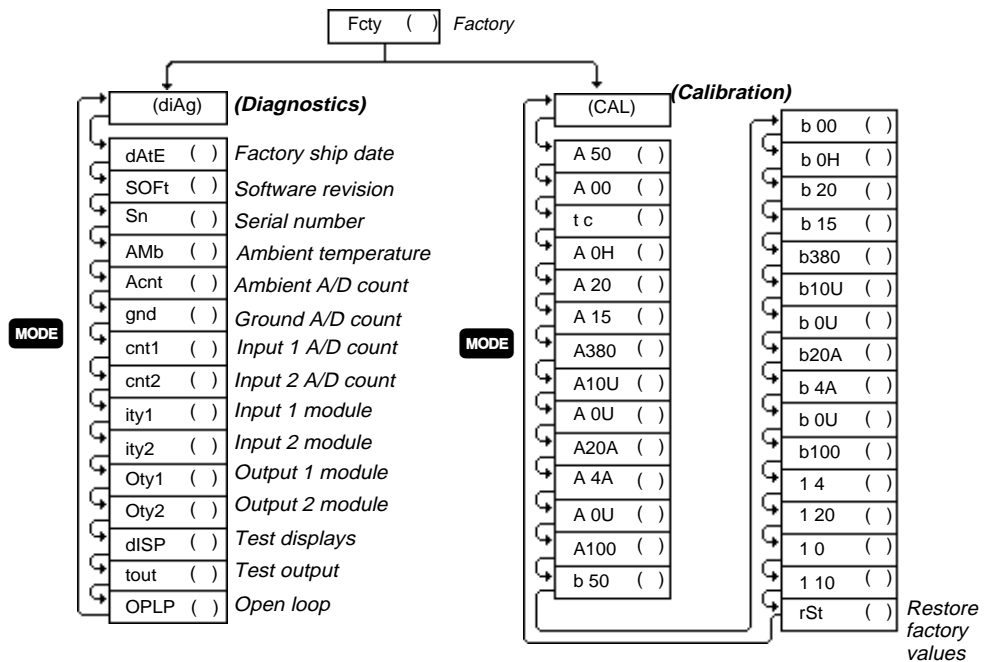

Declaration of Conformity

Series 986, 987, 988, 989

CE 96

WATLOW CONTROLS

1241 Bundy Boulevard

Winona, Minnesota 55987 USA

Declares that the following product:

English

Designation: Series 986, 987, 988, 989
Model Number(s): 9 8 (6, 7, 8 or 9) (Any letter) - (1 or 2) (0 1 2 3 4 or 5) (B C D E F or K) (A B C D E F K or T) - (A B C J K M N or T) (A B C D E K R S or T) (Any two letters)
Classification: Control, Installation Category II, Pollution Degree II
Rated Voltage: 100 to 240V~ or 24 to 28V≈
Rated Frequency: 50/60 Hz
Rated Power Consumption: 16VA maximum

Meets the essential requirements of the following European Union Directive(s) using the relevant section(s) of the normalized standards and related documents shown:

89/336/EEC Electromagnetic Compatibility Directive

EN 50082-2: 1995 EMC Generic immunity standard, Part 2: Industrial environment

EN 61000-4-2: 1995 Electrostatic discharge
EN 61000-4-4: 1995 Electrical fast transients
EN 61000-4-3: 1996 Radiated immunity
EN 61000-4-6: 1996 Conducted immunity
ENV 50204: 1995 Cellular phone

EN 50081-2: 1994 EMC Generic emission standard, Part 2: Industrial environment

EN 55011: 1991 Limits and methods of measurement of radio disturbance characteristics of industrial, scientific and medical radio-frequency equipment (Group 1, Class A)
EN 61000-3-2: 1995 Limits for harmonic current emissions
EN 61000-3-3: 1995 Limitations of voltage fluctuations and flicker

73/23/EEC Low-Voltage Directive

EN 61010-1: 1993 Safety requirements for electrical equipment for measurement, control, and laboratory use, Part 1: General requirements

Déclare que le produit suivant :

Français

Désignation : Série 986, 987, 988, 989
Numéro(s) de modèle(s) : 9 8 (6, 7, 8 ou 9) (lettre quelconque) - (1 ou 2) (0, 1, 2, 3, 4 ou 5) (B, C, D, E, F ou K) (A, B, C, D, E, F, K ou T) - (A, B, C, J, K, M, N ou T) (A, B, C, D, E, K, R, S, ou T) (deux lettres quelconques)

Classification : Commande, installation catégorie II, degré de pollution II

Tension nominale : 100 à 240 V ~ ou 24 à 28 V ≈

Fréquence nominale : 50/60 Hz

Consommation

d'alimentation nominale : 16 VA maximum

Conforme aux exigences de la (ou des) directive(s) suivantes de l'Union Européenne figurant aux sections correspondantes des normes et documents associés ci-dessous :

89/336/EEC Directive de compatibilité électromagnétique

EN 50082-2: 1995 Norme générique d'insensibilité électromagnétique, Partie 2: Environnement industriel

EN 61000-4-2: 1995 Décharge électrostatique
EN 61000-4-4: 1995 Courants électriques transitoires rapides
EN 61000-4-3: 1996 Insensibilité à l'énergie rayonnée
EN 61000-4-6: 1996 Insensibilité à l'énergie par conduction
ENV 50204: 1995 Téléphone cellulaire

EN 50081-2: 1994 Norme générique sur les émissions électromagnétiques, Partie 2: Environnement industriel

EN 55011: 1991 Limites et méthodes de mesure des caractéristiques d'interférences du matériel radiofréquence industriel, scientifique et médical (Groupe 1, Classe A)

EN 61000-3-2: 1995 Limites d'émission d'harmoniques

EN 61000-3-3: 1995 Limitations d'écart de tension et de papillotement

73/23/EEC Directive liée aux basses tensions

EN 61010-1: 1993 Exigences de sécurité pour le matériel électrique de mesure, commande et de laboratoire, Partie 1: Exigences générales

Declaration of Conformity

Erklärt, daß das folgende Produkt:

Deutsch

Beschreibung: Serie 986, 987, 988, 989
Modellnummer(n): 9 8 (6 7 8 oder 9) (beliebiger Buchstabe) - (1 oder 2) (0 1 2 3 4 oder 5) (B C D E F oder K) (A B C D E F K oder T) - (A B C J K M N oder T) (A B C D E K R S oder T) (2 beliebige Buchstaben)

Klassifikation: Regelsystem, Installationskategorie II, Emissionsgrad II

Nennspannung: 100 bis 240 V~ oder 24 bis 28 V≈

Nennfrequenz: 50/60 Hz

Stromverbrauch: Max. 16 VA

Erfüllt die wichtigsten Normen der folgenden Anweisung(en) der Europäischen Union unter Verwendung der untenstehenden einschlägigen Dokumente:

89/336/EEC Elektromagnetische Übereinstimmungsanweisung

EN 50082-2: 1995 EMC-Rahmennorm für Störsicherheit, Teil 2: Industrielle Umwelt

EN 61000-4-2: 1995 Elektrostatische Entladung

EN 61000-4-4: 1995 Elektrische schnelle Stöbe

EN 61000-4-3: 1996 Strahlungsimmunität

EN 61000-4-6: 1996 Leitungsimmunität

ENV 50204: 1995 Mobiltelefon

EN 50081-2: 1994 EMC-Rahmennorm für Emissionen, Teil 2: Industrielle Umwelt

EN 55011: 1991 Beschränkungen und Methoden der Messung von Funkstörungsmerkmalen industrieller, wissenschaftlicher und medizinischer Hochfrequenzgeräte (Gruppe 1, Klasse A)

EN 61000-3-2: 1995 Grenzen der Oberwellenstromemissionen

EN 61000-3-3: 1995 Grenzen der Spannungsrichtlinien zu Flimmern

73/23/EEC Niederspannungsrichtlinie zu entsprechen

EN 61010-1: 1993 Sicherheitsrichtlinien für Elektrogeräte zur Messung, zur Steuerung und im Labor, Teil 1: Allgemeine Richtlinien

Declara que el producto siguiente:

Español

Designación: Series 986, 987, 988, 989
Números de modelo: 9 8 (6 7 8 ó 9)(Cualquier letra) - (1 ó 2)(0 1 2 3 4 ó 5)(B C D E F o K)(A B C D E F K o T) - (A B C J K M N o T)(A B C D E K R S o T)(Cualquier combinación de dos letras)

Clasificación: Control, categoría de instalación II, grado de contaminación ambiental II

Tensión nominal: 100 a 240 V~ o 24 a 28V ≈

Frecuencia nominal: 50/60 Hz

Consumo nominal

de energía: 16 VA máximo

Cumple con los requisitos esenciales de las siguientes directivas de la Unión Europea, usando las secciones pertinentes de las reglas normalizadas y los documentos relacionados que se muestran:

89/336/EEC - Directiva de compatibilidad electromagnética

EN 50082-2: 1995 Norma de inmunidad genérica del EMC, parte 2: Ambiente industrial

EN 61000-4-2: 1995 Descarga electrostática

EN 61000-4-4: 1995 Perturbaciones transitorias eléctricas rápidas

EN 61000-4-3: 1996 Inmunidad radiada

EN 61000-4-6: 1996 Inmunidad conducida

ENV 50204: 1995 Teléfono portátil

EN 50081-2: 1994 Norma de emisión genérica del EMC, parte 2: Ambiente industrial

EN 55011: 1991 Límites y métodos de medición de características de perturbaciones de radio correspondientes a equipos de radiofrecuencia industriales, científicos y médicos (Grupo 1, Clase A)

EN 61000-3-2: 1995 Límites para emisiones de corriente armónica

EN 61000-3-3: 1995 Limitaciones de fluctuaciones del voltaje

73/23/EEC Directiva de baja tensión

EN 61010-1: 1993 Requerimientos de seguridad para equipos eléctricos de medición, control y uso en laboratorios, Parte 1: Requerimientos generales

Erwin D. Lowell

Winona, Minnesota, USA

Name of Authorized Representative

Place of Issue

General Manager

January 9, 1996

Title of Authorized Representative

Date of Issue



Signature of Authorized Representative

Watlow Series 988LF User's Manual

Watlow Controls, 1241 Bundy Boulevard., P.O. Box 5580, Winona, Minnesota USA 55987-5580
Phone: (507) 454-5300, Fax: (507) 452-4507 <http://www.watlow.com>