



# Series 93

## User's Manual



### 1/16 DIN Microprocessor-Based Auto-tuning Control

**User Levels:**

- New User .....go to page 1.1
- Experienced User .....go to page 2.1
- Expert user .....go to page 2.1

**Installers:**

- Installation .....go to page 2.1
- Wiring .....go to page 2.3



1241 Bundy Blvd., P.O. Box 5580, Winona, Minnesota USA 55987-5580  
Phone: (507) 454-5300, Fax: (507) 452-4507 <http://www.watlow.com>



## Safety Information

We use note, caution and warning symbols throughout this book to draw your attention to important operational and safety information.



**CAUTION or  
WARNING**

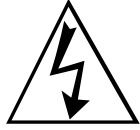

**Electrical  
Shock Hazard**

**CAUTION or WARNING**

A “NOTE” marks a short message to alert you to an important detail.

A “CAUTION” safety alert appears with information that is important for protecting your equipment and performance. Be especially careful to read and follow all cautions that apply to your application.

A “WARNING” safety alert appears with information that is important for protecting you, others and equipment from damage. Pay very close attention to all warnings that apply to your application.

The safety alert symbol,  (an exclamation point in a triangle) precedes a general CAUTION or WARNING statement.

The electrical hazard symbol,  (a lightning bolt in a triangle) precedes an electric shock hazard CAUTION or WARNING safety statement.

## Technical Assistance

If you encounter a problem with your Watlow controller, review your configuration information to verify that your selections are consistent with your application: inputs, outputs, alarms, limits, etc. If the problem persists, you can get technical assistance from your local Watlow representative (see back cover), by e-mailing your questions to [wintechsupport@watlow.com](mailto:wintechsupport@watlow.com) or by dialing +1 (507) 494-5656 between 7 a.m. and 5 p.m., Central Standard Time (CST). Ask for for an Applications Engineer. Please have the following information available when calling:

- Complete model number
- All configuration information
- User’s Manual
- Factory Page

## Warranty

The Series 93 is manufactured by ISO 9001-registered processes and is backed by a three-year warranty.

## Return Material Authorization (RMA)

1. Call Watlow Customer Service, (507) 454-5300, for a Return Material Authorization (RMA) number before returning any item for repair. If you do not know why the product failed, contact an Application Engineer or Product Manager. All RMA’s require:

- Ship to address
- Contact name
- Method of return shipment
- Detailed description of the problem
- Name and phone number of person returning the product.
- Bill to address
- Phone number
- Your P.O. number
- Any special instructions

2. Prior approval and an RMA number from the Customer Service Department is required when returning any product for credit, repair or evaluation. Make sure the RMA number is on the outside of the carton and on all paperwork returned. Ship on a Freight Prepaid basis.

3. After we receive your return, we will examine it and try to verify the reason for returning it.

4. In cases of manufacturing defect, we will enter a repair order, replacement order or issue credit for material returned. In cases of customer mis-use, we will provide repair costs and request a purchase order to proceed with the repair work.

5. To return products that are not defective, goods must be in new condition, in the original boxes and they must be returned within 120 days of receipt. A 20 percent restocking charge is applied for all returned stock controls and accessories.

6. If the unit is unrepairable, you will receive a letter of explanation. and be given the option to have the unit returned to you at your expense or to have us scrap the unit.

7. Watlow reserves the right to charge for no trouble found (NTF) returns.

The Series 93 User’s Manual is copyrighted by Watlow Winona, Inc., © October 2003 with all rights reserved. (2405)

<b>Chapter 1: Overview</b> .....	1.1
General Description .....	1.1
<b>Chapter 2: Install And Wire The Series 93</b> .....	2.1
Panel Cutout .....	2.1
Dimensions .....	2.1
Installation Procedure .....	2.1
Wiring the Series 93 .....	2.3
Power Wiring .....	2.3
Sensor Installation Guidelines .....	2.4
Input Wiring .....	2.4
Output 1 Wiring .....	2.6
Output 2 Wiring .....	2.8
System Wiring Example .....	2.9
<b>Chapter 3: How To Use The Keys And Displays</b> .....	3.1
Keys, Displays and Indicator Lights .....	3.1
<b>Chapter 4: How To Set Up The Series 93</b> .....	4.1
Setting the Input Type DIP Switch .....	4.1
Entering Setup Menu .....	4.2
Setup Parameters .....	4.3
Setup Menu Table .....	4.5
Operation Parameters .....	4.6
Operation Menu Table .....	4.7
<b>Chapter 5: How To Tune And Operate</b> .....	5.1
Autotuning .....	5.1
Manual Tuning .....	5.2
Manual and Automatic Operation .....	5.3
Setting the Set Point .....	5.3
Using Alarms .....	5.4
Error Code Messages .....	5.5
Error Code Actions .....	5.6
<b>Appendix</b> .....	A.1
Noise and Installation Guidelines .....	A.1
Noise Sources .....	A.1
Decreasing Noise Sensitivity .....	A.1
Eliminating Noise .....	A.2
Entering the Calibration Menu .....	A.3
Restoring Factory Calibration .....	A.4
Calibration Menu .....	A.4
Calibration Procedures .....	A.5
Glossary .....	A.9
Specifications .....	A.12
Model Number Information .....	A.13
Index .....	A.14
Declaration of Conformity .....	A.15
Quick Reference .....	A.17

## Figures and Tables

<b>Figures</b> .....	<b>Page</b>
Series 93 Input and Output Overview .....	1.1
Series 93 Multiple Panel Cutout Dimensions .....	2.1a
Series 93 Dimensions .....	2.1b
Mounting, Case Side View .....	2.2a
Mounting Collar .....	2.2b
Case Rear View and IP65 (NEMA 4X) Seal Example .....	2.2c
Power Wiring .....	2.3
Thermocouple Sensor Input Wiring .....	2.4a
2- or 3-wire RTD Sensor Input Wiring .....	2.4b
0-5V <sub>DC</sub> (dc) Process Sensor Input Wiring .....	2.5a
4-20mA Process Sensor Input Wiring .....	2.5b
Output 1 Mechanical Relay Wiring .....	2.6a
Output 1 Solid-state Relay w/o Suppression Wiring .....	2.6b
Switched DC Output 1 Wiring .....	2.7a
4-20mA Process Wiring .....	2.7b
Output 2 Mechanical Relay Wiring .....	2.8a
Output 2 Solid-state Relay w/o Suppression Wiring .....	2.8b
Switched DC Output 2 Wiring .....	2.8c
System Wiring Example .....	2.9
Wiring Notes .....	2.10
Series 93 Keys and Displays .....	3.1
DIP Switch Location and Orientation .....	4.1a
Input DIP Switches .....	4.1b
Entering the Setup Menu .....	4.2a
The Setup Menu .....	4.2b
The Operation Menu .....	4.6
Autotuning at a 200°F Set Point .....	5.1
Clearing an Alarm .....	5.4
Error Code Message .....	5.5
Entering the Calibration Menu .....	A.3
Calibration Menu .....	A.4

<b>Tables</b> .....	<b>Page</b>
Input Ranges .....	4.5a
Setup Menu Prompts and Descriptions .....	4.5b
Operation Menu Prompts and Descriptions .....	4.7
Quick Reference Sheet .....	A.17-A.18

# Notes

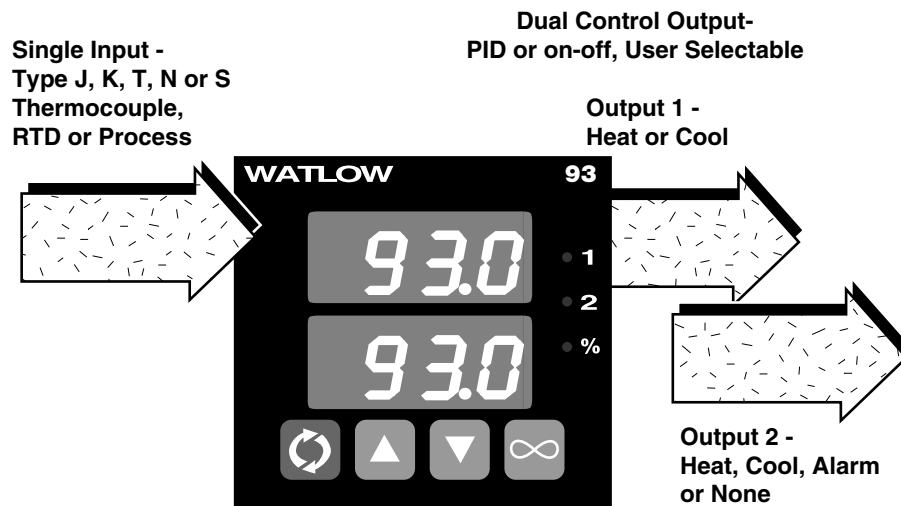

Figure 1.1 -  
Series 93 Input and  
Output Overview.

## General Description

Welcome to the Watlow Series 93, a 1/16 DIN microprocessor-based temperature controller. The 93 has a single input which accepts type J, K, T, N or S thermocouple, RTD or process input.

With dual output, the primary output can be heating or cooling while the secondary output can be a control output opposite the primary output (heat or cool), alarm or none. Both outputs can be selected as either PID or on-off. PID settings include proportional band, reset/integral, and rate/derivative. Setting the proportional band to zero makes the Series 93 a simple on-off controller with switching differential selectable under the **HSC** parameter.

Special 93 features include the optional NEMA 4X rating, optional CE compliance, dual four-digit displays in either red or green, optional low-voltage power supply, autotuning for both heat and cool outputs, ramp to set point for gradual warm-up of your thermal system, and automatic/manual capability with bumpless transfer.

Operator-friendly features include automatic LED indicators to aid in monitoring and setup, as well as a calibration offset at the front panel. The Watlow Series 93 automatically stores all information in a non-volatile memory.

# Notes

# 2

## Install and Wire the Series 93

**NOTE:**

For rapid mounting, use Greenlee 1/16 DIN punch, die, draw stud, part number 60287.

**NOTE:**

Measurements between panel cutouts are the minimum recommended.

Figure 2.1a - Series 93 Multiple Panel Cutout Dimensions.

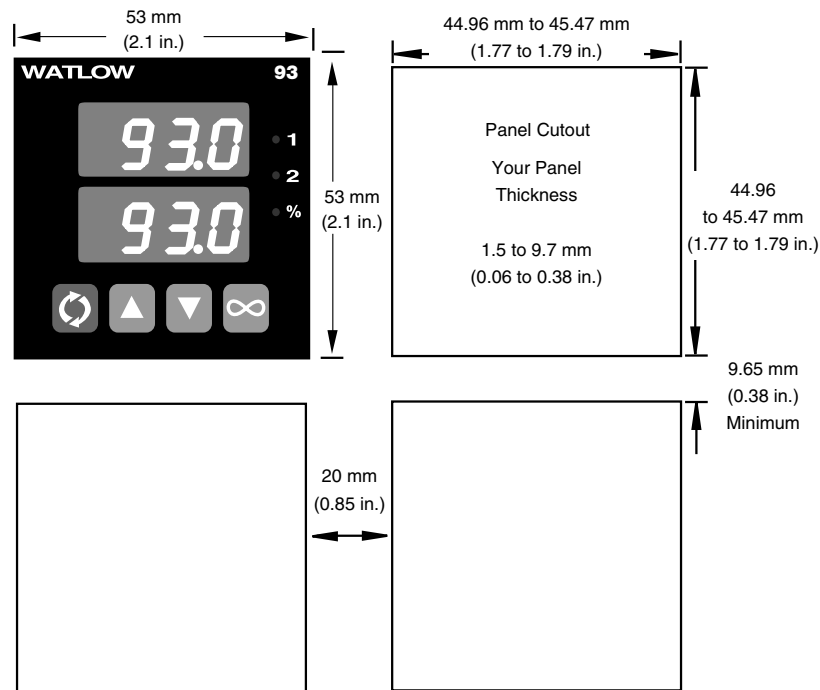
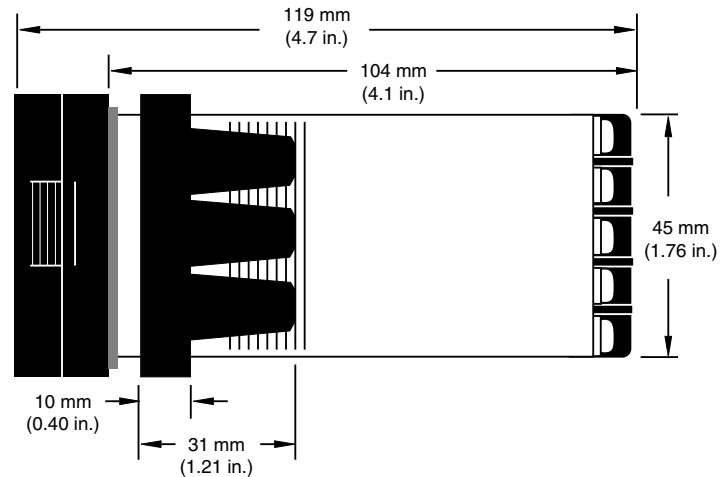

Figure 2.1b- Series 93 Dimensions.



## Installation procedure

**Bold print denotes requirement for IP65 (NEMA 4X) seal.** Follow this procedure to mount the Watlow Series 93 temperature controller:

1. Make a panel cutout using the dimensions in Figure 1a.
2. **If your controller model number begins with 93B, make sure the rounded side of the external case gasket is facing the panel surface.** Check to see that the gasket is not twisted, and is seated within the case bezel flush with the panel. Place the case in the cutout. Make sure the gasket is between the panel cutout and the case bezel.

**Figure 2.2a -  
Mounting Case Side  
View.**

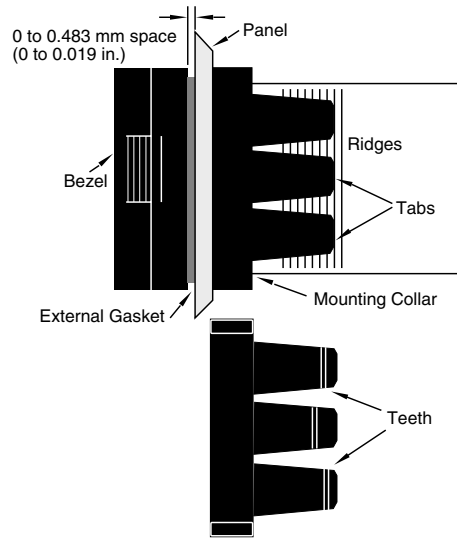

**Figure 2.2b -  
Mounting Collar  
Cross Section with  
offset teeth.**

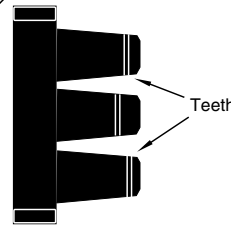

3. While pressing the front of the case firmly against the panel, slide the mounting collar over the back of the controller. The tabs on the collar must line up with the mounting ridges on the case for secure installation. See Figure 2a. Slide the collar firmly against the back of the panel getting it as tight as possible.

To ensure a tight seal, use your thumb to lock the tabs into place while pressing the case from side to side. Don't be afraid to apply enough pressure to install the controller. The tabs on each side of the collar have teeth which latch into the ridges. See Figure 2b. Each tooth is staggered at a different height, so only one of the tabs on each side are ever locked into the ridges at any time.

Confirm that the tabs on one side of the collar correspond with those on the opposite side. Make sure the two corresponding tabs are the only ones locked in the ridges at the same time.

**If the corresponding tabs are not supporting the case at the same time, and the space between the panel and the case bezel is greater than .019 inch, you will not have a IP65 (NEMA 4X) seal. This applies to units with models designated 93B.** However, all units should be mounted in this fashion to guarantee integrity of the mounting system.



**CAUTION:** Follow the installation procedure exactly to guarantee a proper IP65 (NEMA 4X) seal. Make sure the gasket between the panel and the rim of the case is not twisted and is seated properly. Failure to do so could result in damage to equipment.

**Figure 2.2c -  
Case Rear View and  
IP65 (NEMA 4X) Seal  
Example.**

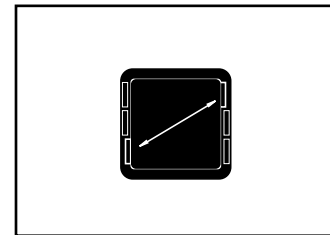
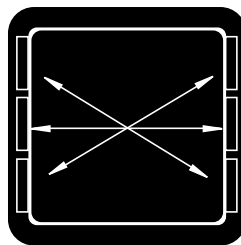

Make sure that the two corresponding tabs are locked in the ridges at the same time.

IP65 (NEMA 4X) Seal Example.

4. Insert the controller chassis into its case and press the bezel to seat it. Make sure the inside gasket is also seated properly and not twisted. The hardware installation is complete. Proceed to the wiring section from here.

### Removing the Series 93 Controller

When removing the mounting collar, we suggest using a thin tool such as a putty knife or screwdriver to pry gently under each of the six tabs to disengage the teeth. Then rock the collar back and forth until it can be easily pulled off the case.





**WARNING:** To avoid electric shock, use National Electric Code (NEC) safety practices when wiring and connecting this unit to a power source and to electrical sensors or peripheral devices. Failure to do so could result in injury or death.

**NOTE:**

Taking the unit out of the case is not a normal operating condition and should only be done by a qualified maintenance installation technician. Power to the case should be disconnected before removing or installing the controller into its case.



**WARNING:** The case terminals may still carry live voltage when the unit is removed.



**WARNING:** Irreversible damage will occur if high voltage is applied to the low voltage unit.

# Wiring the Series 93

The Series 93 wiring is illustrated by model number option. Check the unit sticker on the controller and compare your model number to those shown here and also the model number breakdown in the Appendix of this manual.

All outputs are referenced to a de-energized state. The final wiring figure is a typical system example.

When you apply power without sensor inputs on the terminal strip, the Series 93 displays `----` in the upper display, and `0` in the lower display, except for 0-5V<sub>DC</sub> (dc) or 4-20mA process input units. Press the  $\infty$  Infinity key twice, and `Er 7` is displayed for one second. This error indicates an open sensor or an analog-to-digital error. All wiring and fusing must conform to the National Electric Code and to any locally applicable codes as well.

## Power Wiring

### High Voltage

100 to 240~ (ac), nominal (85 to 264 actual) 93\_\_-1\_\_0-00\_\_

### Low Voltage

12 to 24V<sub>AC/DC</sub> (ac/dc) 93\_\_-1\_\_1-00\_\_

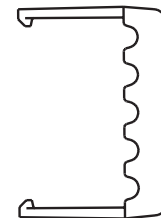
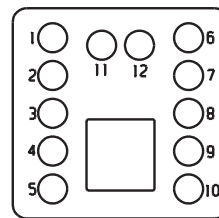
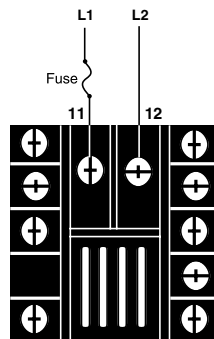
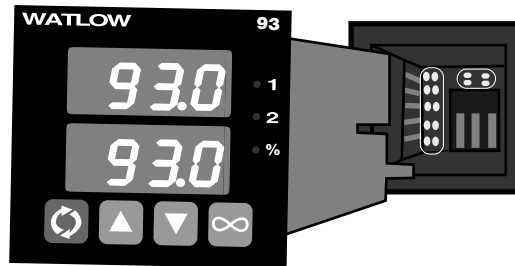

Figure 2.3 – Power Wiring.

**NOTE:** Optional protective rear terminal cover, 0822-0426-P001, is available. Contact Watlow customer service or your local Watlow sales representative.



**WARNING:** To avoid electric shock and damage to property and equipment, use National Electric Code (NEC) safety practices when wiring and connecting this unit to a power source and to electrical sensors or peripheral devices. Failure to do so could result in injury or death.

# Sensor Installation Guidelines

We suggest you mount the sensor at a location in your process or system where it reads an average temperature. Put the sensor as near as possible to the material or space you want to control. Air flow past this sensor should be moderate. The sensor should be thermally insulated from the sensor mounting.

See Chapter 4 for more information on DIP switch location and orientation.

## Input Wiring

**NOTE:**

When an external device with a non-isolated circuit common is connected to the 4-20mA or dc output, you must use an isolated or ungrounded thermocouple.

Figure 2.4a – Thermocouple

Extension wire for thermocouples must be of the same alloy as the thermocouple itself to limit errors.

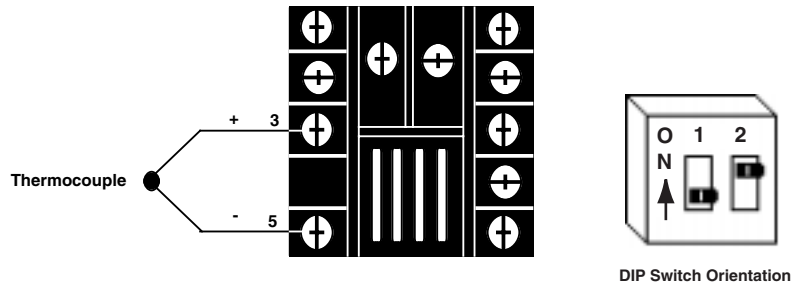
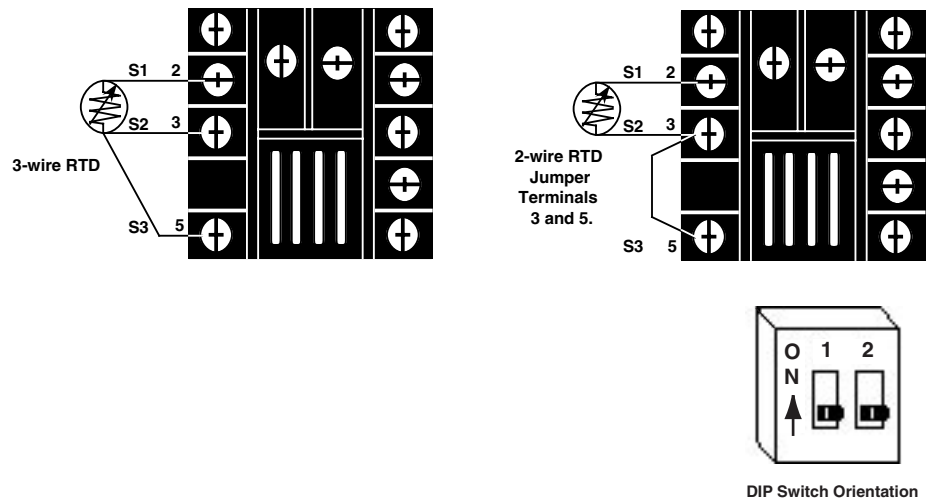

Figure 2.4b – RTD (2- or 3-Wire) 100Ω Platinum

There could be a + 2°F input error for every 1Ω of lead length resistance when using a 2-wire RTD. That resistance, when added to the RTD element resistance, will result in erroneous input to the instrument. To overcome this problem, use a 3-wire RTD sensor, which compensates for lead length resistance. When extension wire is used for a 3-wire RTD, all wires must have the same electrical resistance (i.e. same gauge, same length, multi-stranded or solid, same metal).



**NOTE:**

Successful installation requires four steps:

- Choose the controller's hardware configuration and model number (Appendix);
- Choose a sensor (Chapter Two and Appendix);
- Install and wire the controller (Chapter Two);
- Configure the controller (Chapters Three, Four and Five).



**WARNING:** To avoid damage to property and equipment, and/or injury or loss of life, use National Electric Code (NEC) standard wiring practices to install and operate the Series 93. Failure to do so could result in such damage, and/or injury or death.

**NOTE:**

When an external device with a non-isolated circuit common is connected to the 4-20mA or dc output, you must use an isolated or ungrounded thermocouple.



**CAUTION:** Process input does not have sensor break protection. Outputs can remain full on.

### Figure 2.5a – 0-5V<sub>dc</sub> Process

Input impedance: 10k $\Omega$

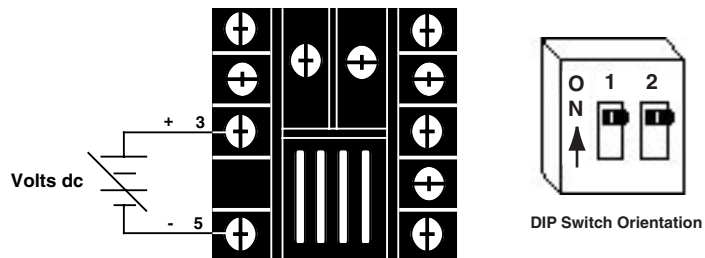

### Figure 2.5b – 4-20mA Process

Input impedance: 5 $\Omega$

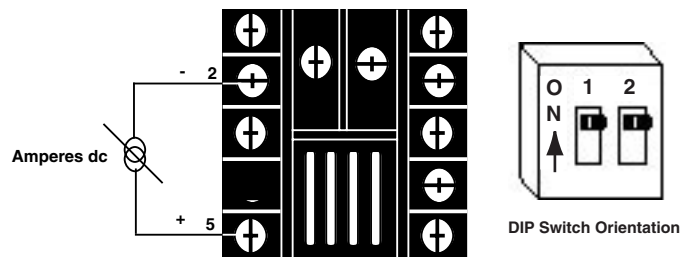

### Figure 2.5c – 4-20mA Process: 2-Wire Transmitters

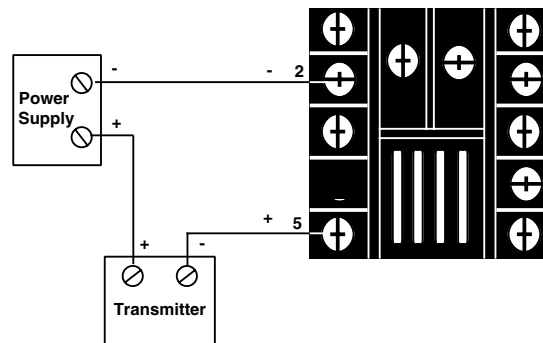

**NOTE:**

Successful installation requires four steps:

- Choose the controller's hardware configuration and model number (Appendix);
- Choose a sensor (Chapter Two and Appendix);
- Install and wire the controller (Chapter Two);
- Configure the controller (Chapters Three, Four and Five).

# Output 1 Wiring

Figure 2.6a – Mechanical Relay Without Contact Suppression

93\_\_ - 1 D \_\_ - 00 \_\_

Form C, 5A

Minimum load current:  
100mA @ 5V $\overline{\text{dc}}$  (dc)

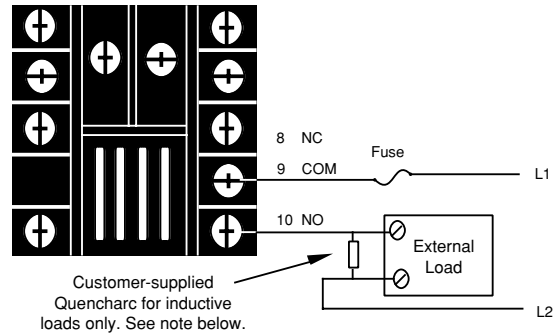
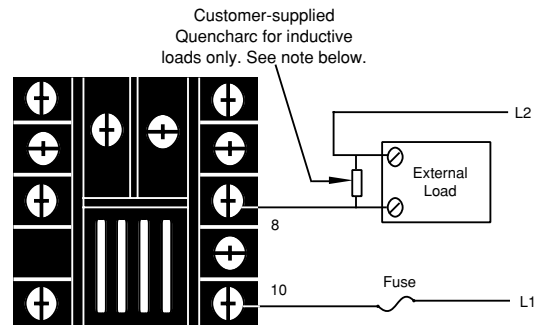

Figure 2.6b – Solid-state Relay Without Contact Suppression

93\_\_ - 1 K \_\_ - 00 \_\_

0.5A (ac loads only)



**WARNING:** To avoid damage to property and equipment, and/or injury or loss of life, use National Electric Code (NEC) standard wiring practices to install and operate the Series 93. Failure to do so could result in such damage, and/or injury or death.

**NOTE:**

Switching inductive loads (relay coils, solenoids, etc.) with the mechanical relay, switched dc or solid-state relay output options requires use of an R.C. suppressor.

Watlow carries the R.C. suppressor Quencharc brand name, which is a trademark of ITW Paktron. Watlow Part No. 0804-0147-0000.

**NOTE:**

Successful installation requires four steps:

- Choose the controller's hardware configuration and model number (Appendix);
- Choose a sensor (Chapter Two and Appendix);
- Install and wire the controller (Chapter Two);
- Configure the controller (Chapters Three, Four and Five).

**NOTE:**

When an external device with a non-isolated circuit common is connected to the 4-20mA or dc output, you must use an isolated or ungrounded thermocouple.

Figure 2.7a – **Switched DC**

93\_\_-1 C \_\_-00 \_\_

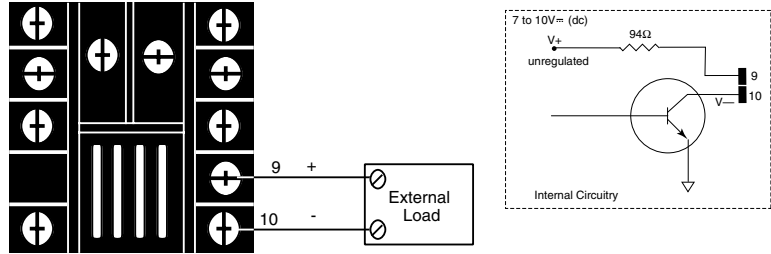
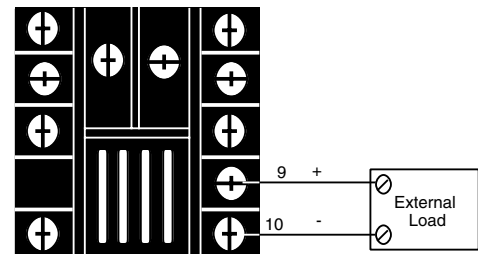

Figure 2.7b – **4-20mA Process**

93\_\_-1 F \_\_-00 \_\_

Maximum load impedance: 800Ω



**NOTE:**

Successful installation requires four steps:

- Choose the controller's hardware configuration and model number (Appendix);
- Choose a sensor (Chapter Two and Appendix);
- Install and wire the controller (Chapter Two);
- Configure the controller (Chapters Three, Four and Five).

**NOTE:**

Output is in open state in Alarm Condition.

**NOTE:**

Switching inductive loads (relay coils, solenoids, etc.) with the mechanical relay, switched dc or solid-state relay output options requires use of an R.C. suppressor.

Watlow carries the R.C. suppressor Quencharc brand name, which is a trademark of ITW Paktron. Watlow Part No. 0804-0147-0000.



**WARNING:** To avoid damage to property and equipment, and/or injury or loss of life, use National Electric Code (NEC) standard wiring practices to install and operate the Series 93. Failure to do so could result in such damage, and/or injury or death.

# Output 2 Wiring

Figure 2.8a – Mechanical Relay Without Contact Suppression

93\_\_-1\_D\_-00\_\_

Form C, 5A

Minimum load current:  
100mA @ 5V<sub>DC</sub> (dc)

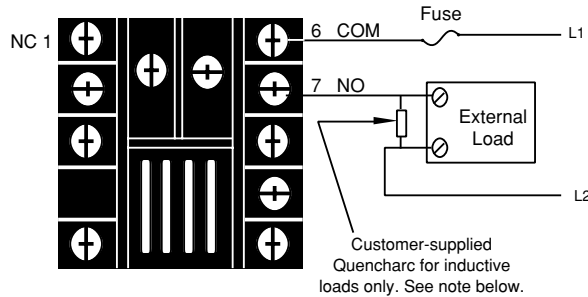

Figure 2.8b – Solid-state Relay Without Contact Suppression

93\_\_-1\_K\_-00\_\_

0.5A (ac loads only)

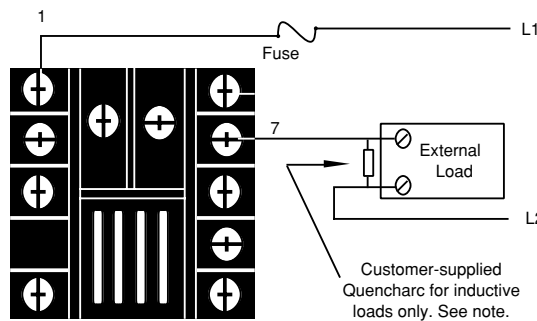
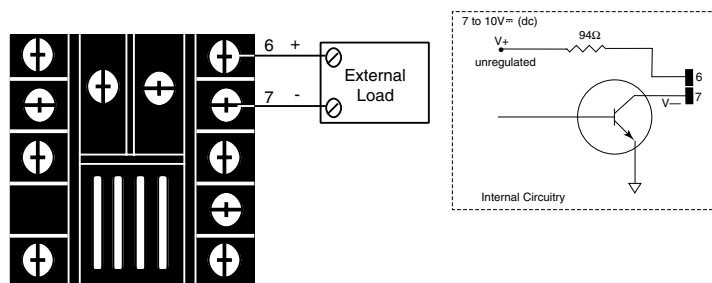

Figure 2.8c – Switched DC

93\_\_-1\_C\_-00\_\_





**WARNING:** To avoid damage to property and equipment, and/or injury or loss of life, use National Electric Code (NEC) standard wiring practices to install and operate the Series 93. Failure to do so could result in such damage, and/or injury or death.

# Wiring Example

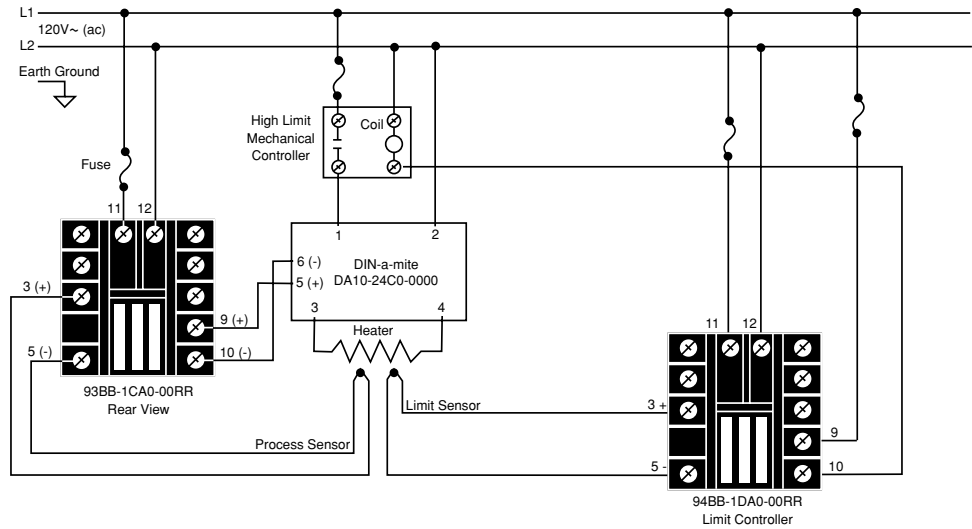

Install and Wire

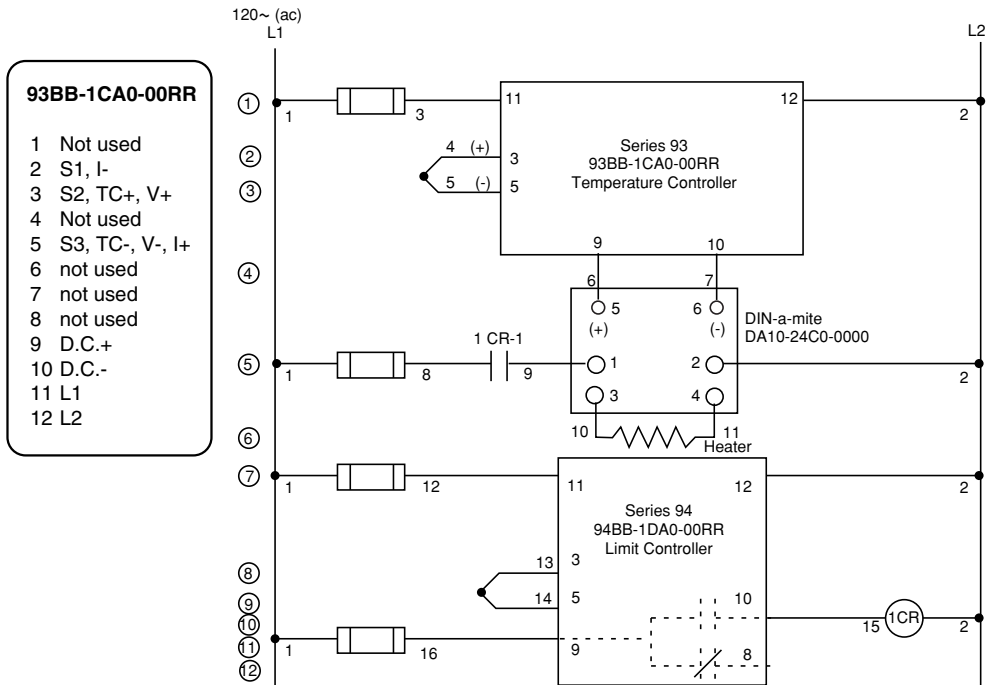

Figure 2.9 - System Wiring Example.



**WARNING:** To avoid electric shock and damage to property and equipment, use National Electric Code (NEC) safety practices when wiring and connecting this unit to a power source and to electrical sensors or peripheral devices. Failure to do so could result in injury or death.



**WARNING:** Install high or low temperature limit control protection in systems where an over temperature fault condition could present a fire hazard or other hazard. Failure to install temperature limit control protection where a potential hazard exists could result in damage to equipment, property and injury to personnel.



**WARNING:** All wiring and fusing must conform to the National Electric Code NFPA70. Contact your local board for additional information. Failure to observe NEC safety guidelines could result in injury to personnel or damage to property.

# Wiring Notes

Sketch in your application on this page or a copy of it. See the wiring example in this chapter.

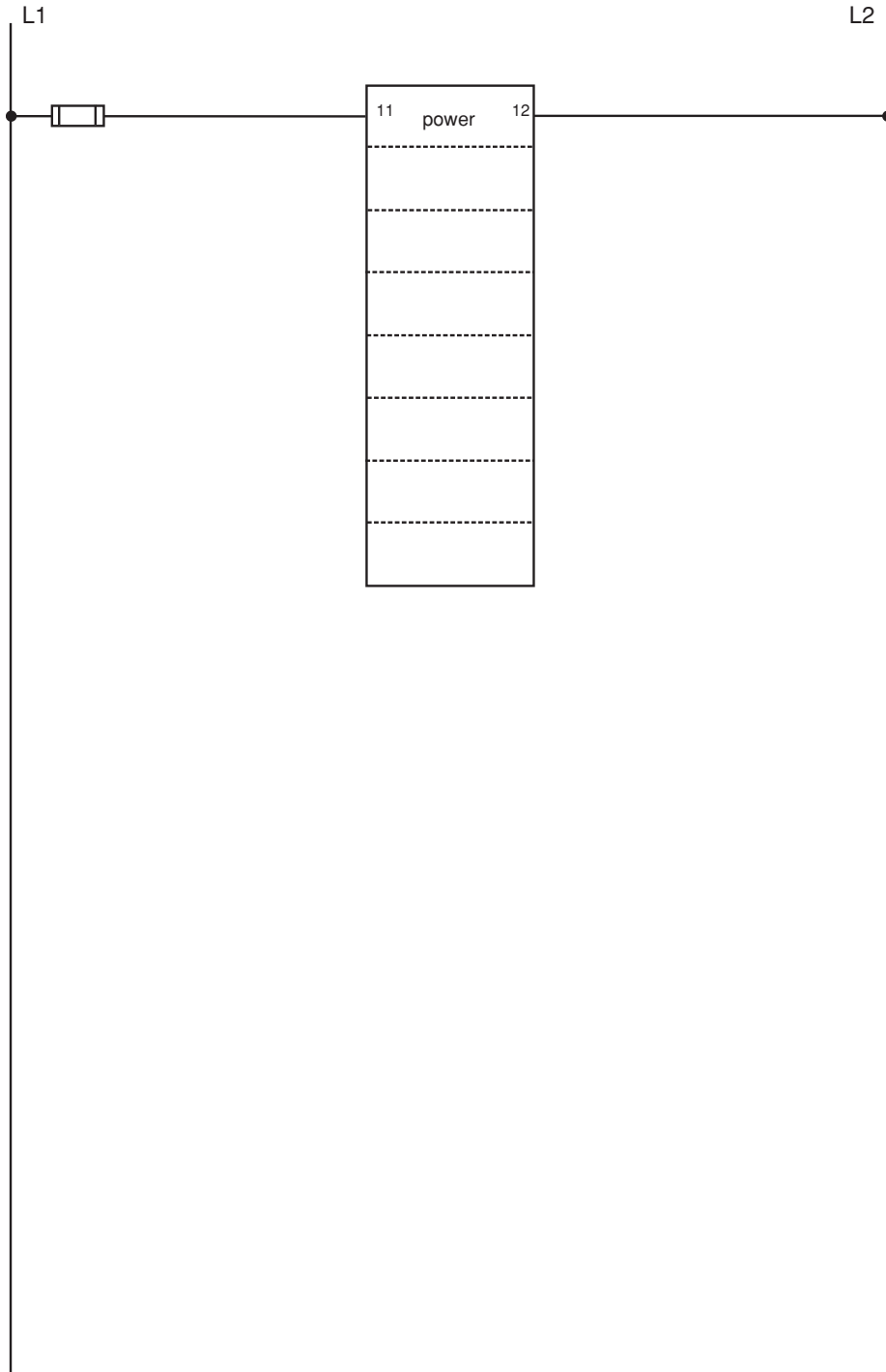

Figure 2.10 - Wiring Notes.



# 3

## How to Use the Key and Displays

After 60 seconds with no key presses, the controller reverts to the default display — the process value in the upper display and the set point in the lower display.

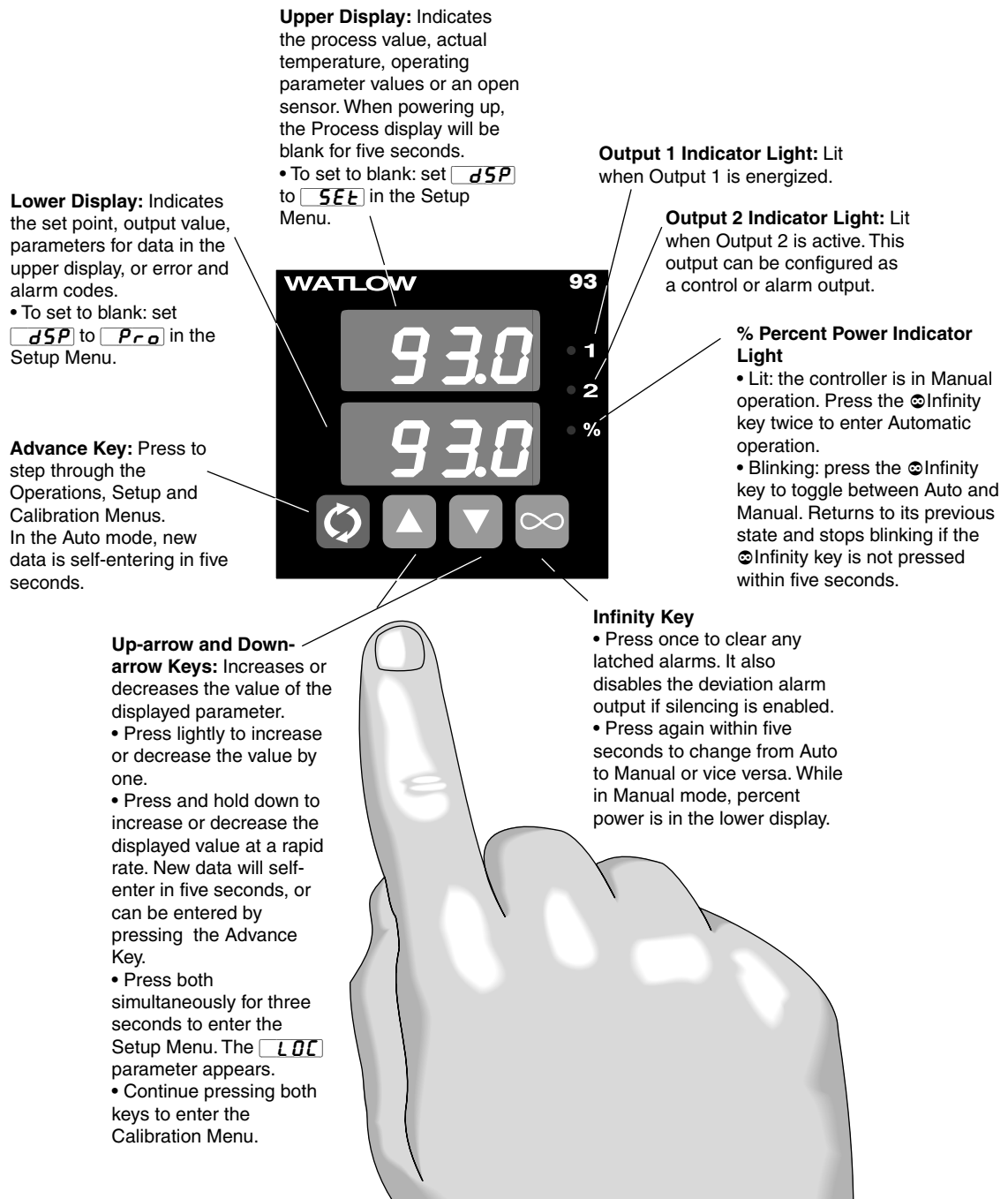

Figure 3.1 - Series 93 Keys and Displays.

# Notes

# 4

## How to Set Up the Series 93

Setting up the Series 93 is a simple process. First set the DIP switches to match your input type. Refer to the orientation below for the  Input value. Next, configure the Series 93's features to your application in the Setup Menu, then enter values in the Operation Menu. Both tasks use the **⏩** Advance key to move through the menus and the Up-arrow/Down-arrow keys to select data.

Before entering information in the Setup Menu, set the  parameter. If  is selected, °C, proportional band in % of span, derivative and integral are the defaults. If  is selected, °F, proportional band in degrees, reset and rate are the defaults. **Changing the  prompt will set parameters to their factory default. Document all current parameter settings first.** See the calibration section in the Appendix to change this parameter.



### WARNING:

Remove power from the controller before removing the chassis from the case or changing the DIP switches. Removing the controller from the chassis is not a normal operating condition and should only be done by a qualified technician.

### Setting the Input Type DIP Switch

The Series 93 input type can be user selectable at any time via a Dual In-line Package (DIP) switch inside the control, located on the left (viewed from the bottom). To set the DIP switch, remove the control chassis from the case. Holding each side of the bezel, press in firmly on the side grips until the tabs release. You may need to rock the bezel back and forth several times to release the chassis.

The locations of the board and switches appear in Figure 1. Refer to the input types below for DIP switch orientation. The DIP switch configuration must match the sensor selected under the  parameter in the Setup Menu.

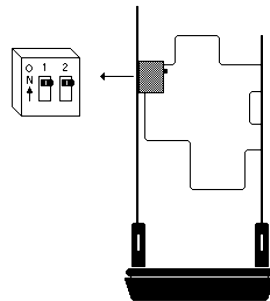

Controller Chassis - Bottom View

Figure 4.1a - DIP Switch Location and Orientation.

### Thermocouple

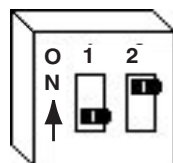

### RTD

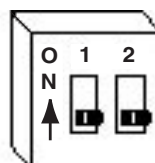

### Process

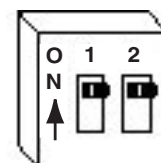

Input Types

Figure 4.1b - Input DIP Switches.

## Menu Structure and Programming

The Series 93 controller has two menus that are used to determine the configuration and operation of the controller. They are the Setup Menu and the Operation Menu. If you are installing the Series 93 controller, you will need to determine the proper settings for both the Setup and Operation Menus. If the controller is already installed in equipment you have purchased, you may only need to set a few of the parameters to adjust the controller to your specific usage of the equipment. The Setup Menu displays the parameters that configure the Series 93's features to your application.

### Entering the Setup Menu

Enter the Setup Menu by pressing the **▲**Up-arrow and **▼**Down-arrow keys simultaneously for 3 seconds. The lower display shows the **LOC** Lock parameter, and the upper display shows its current level. All keys are inactive until you release both keys. You can reach the Lock parameter from anywhere.

Figure 4.2a - Entering the Setup Menu.

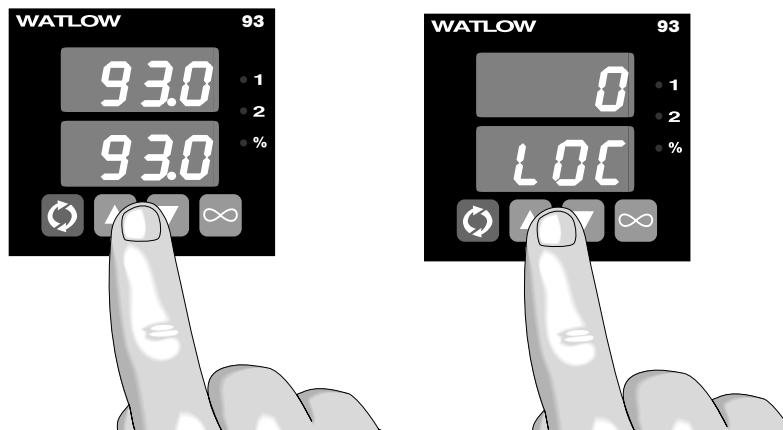

Use the **▶**Advance key to move through the menus and the **▲**Up-arrow and **▼**Down-arrow keys to select data. You will not see all parameters in this menu, depending on the controller's configuration and model number. After stepping through the menu it returns to the set point parameter. If no keys are pressed for approximately 60 seconds, the controller returns to the default display, Process over Set Point.

Figure 4.2b - The Setup Menu.

**NOTE:**  
While in the Setup Menu, all outputs are off.

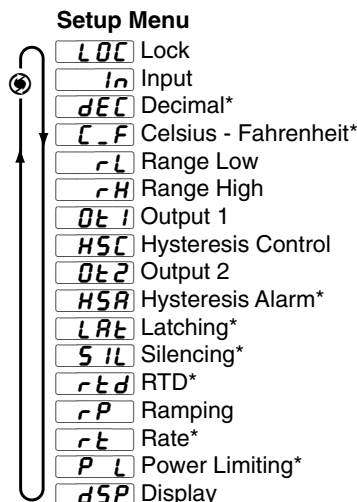

\* Parameter may not always appear.

# Setup Parameters

**NOTE:**

Shaded parameters may not appear, depending on the controller's configuration and model number.

**LOC**

**NOTE:**

Set the **LOC** parameter value as the final step in programming the Series 93 controller to prevent locking yourself out of the Operation and Setup Menu during initial programming.



**CAUTION:**

A process input does not have sensor break protection or bumpless transfer.



**CAUTION:**

Changing **ln** sets all parameters to factory defaults. Document all settings before changing this parameter.

**ln**

**dEC**

**C-F**

**rL**

At the top of the Setup Menu the Series 93 displays the user level of operation in the upper display and the **LOC** parameter in the lower display.

Press the **Advance** key and the value of the next parameter appears in the upper display, and the parameter appears in the lower display.

**Lock:** Selects the level of operator lock-out as defined below.

**Range:** 0 to 4      **Default:** 0

**0:** All operating parameters may be viewed or changed. Manual operation **is** permitted. When in manual operation, percent power is adjustable. Bumpless transfer to manual mode will occur on sensor break.

**1:** The set point, process value and alarm settings are the only visible parameters, set point **is** adjustable in this level. Manual operation and auto-tune **are** permitted. When in manual operation, percent power is adjustable. Bumpless transfer to manual mode will occur on sensor break.

**2:** The set point, process value and alarm settings are the only visible parameters, set point **is** adjustable in this level. Manual operation **is** permitted. When in manual operation, percent power is adjustable. Bumpless transfer to manual mode will occur on sensor break.

**3:** The set point and process value are the only visible parameters, set point **is** adjustable in this level. Manual operation is **not** permitted. Bumpless transfer is defeated and outputs are disabled on sensor break.

**4:** The set point and process value are the only visible parameters, set point is **not** adjustable in this level of lock-out. Manual operation is **not** permitted. Bumpless transfer is defeated and outputs are disabled on sensor break.

**Input:** Selects the sensor input type. The internal DIP switch must also match the **ln** parameter. See DIP switch orientation, and see input type temperature ranges in the following chart. See **CAUTION** at right.

**Range:** **J**, **H** (K), **t**, **n**, **S**, **rtd**, **rtd**, **0-5**, **420**      **Default:** J

**Decimal:** Selects the location of the decimal point for all process-related data. This parameter only appears if the **ln** parameter is set to 0-5 or 420.

Make sure the internal DIP switch matches the **ln** parameter.

**Range:** 0, 0.0, 0.00      **Default:** 0

**Celsius — Fahrenheit:** Selects the units of temperature measurement for the control. This parameter only appears if the **ln** parameter is set to a thermocouple or RTD input. The default is dependent on the **dFL** parameter located in the Calibration Menu. Refer to the Appendix.

**Range:** **C** or **F**

If **dFL** is set to **S1**: **Default:** **C**

If **dFL** is set to **U5**: **Default:** **F**

**Range Low:** Selects the low limit of the set point. Also used to scale the low end of the process input. 0.0V<sub>DC</sub> and 4mA represent **rL** Range Low for a process input. The process input is linearly scaled between **rL** and **rH**. See the model number and specification in the Appendix for range values, or refer to the following table.

**Range:** Sensor range low to **rH** Range High

**Default:** Low limit of sensor type for a thermocouple or RTD. -500 for a process input.

**rh**

**Range High:** Selects the high limit of the operating range. Also used to scale the high end of the process input. 5.0V<sub>DC</sub> and 20mA represent Range High  for a process input. The process input is linearly scaled between  and . See the model number and specification information in the Appendix for your range values, or refer to the following table.

**Range:** Sensor range high to

**Default:** High limit of sensor type for a thermocouple or RTD. 9999 for process input.

**0t1**

**Output 1:** Selects the action for the primary output in response to the difference between set point and process variable. Select  (heat) for reverse acting or select  (cool) for direct acting.

**Range:** ,       **Default:**

**HSC**

**Hysteresis-Control:** Selects the switching hysteresis for control outputs when you select 0 (on-off) under the  parameter.

**Range:** 1 to 55, 0.1 to 5.5, 0.01 to 0.55°C/1 to 99, 0.1 to 9.9, 0.01 to 0.99°F

**Default:** 2, 0.2, 0.02°C/3, 0.3, 0.03°F

**0t2**

**Output 2:** Selects the output action for the secondary output.

**Range:**  Control mode opposite Output 1 (heat or cool)  
 Process alarm with alarm message displayed  
 Process alarm with no alarm message displayed  
 Deviation alarm with alarm message displayed  
 Deviation alarm with no alarm message displayed  
 None

**Default:**

**HSA**

**Hysteresis - Alarm:** Selects the switching hysteresis for Output 2 when  is an alarm. Appears only if  is not set to  or . See the Operation Menu for .

**Range:** 1 to 5555, 0.1 to 555.5, 0.01 to 55.5°C/1 to 9999, 0.1 to 999.9, 0.01 to 99.99°F

**Default:** 2, 0.2, 0.02°C/3, 0.3, 0.03°F

**LAt**

**Latching:** Selects whether the alarm is latching or non-latching. Latching alarms must be cleared by pressing the ∞Infinity key before the alarm output will reset. Selecting non-latching will automatically reset the alarm output when the condition clears. Appears only if  is not set to  or .

**Range:**  or       **Default:**

**SIL**

**Silencing:** Selects alarm silencing (inhibit) for the alarm. Appears only when  is set to  or . For more information see Chapter 5.

**Range:**  or       **Default:**

**rtd**

**RTD:** Selects the RTD calibration curve for RTD inputs. Will not appear unless  is set to  or .  is 0.003916Ω/Ω°C,  is 0.003850Ω/Ω°C.

**Range:**  or       **Default:**

**rP**

**Ramping:** Choose , and the set point ramps at the selected rate in °/hr. from the process (actual) temperature to the set point, when power is applied to the controller (start up). It will not ramp with a set point change.  is the same as , but ramps *with* a set point change. It ramps from the previous set point to a new one at the selected ramp rate. Select  for no ramping action. When ramping, the lower display alternately flashes . The set point displayed is the desired end set point. The ramping set point is not shown. Entering the Setup Menu or manual operation disables the outputs and ramp. Once you exit either one, the Series 93 controls to the last entered set point.

**Range:** , ,       **Default:**

**rt**

**Rate:** Selects the ramping rate in degrees per hour. Will not appear if  is set to .

**Range:** 0 to 9999      **Default:** 100°/hr.

**PL**

**Power Limiting:** The power limiting function in % power for heat only. Power Limiting will function if **Pbl** is not set to **0**.

**Range:** Dependent on output type. 0 to 100 **Default:** 100

**dSP**

**Display:** Selects which displays are active or viewable. Five seconds after selected, the appropriate display goes blank. Press **⏩** Advance, **⬆** Up-arrow or **⬇** Down-arrow to override this feature and cause the current value to be displayed for 5 seconds.

**Range:** **nor** Normal displays **Default:** **nor**

**SEt** Set Point - lower display only

**Pro** Process - upper display only

Table 4.5a - Input Ranges.

**NOTE:**

Document your Setup Menu parameters below. Do not mark any values here; make photocopies instead.

Input Type	Sensor Range Low	Sensor Range High
<b>J</b>	0°C/32°F	750°C/1382°F
<b>H</b>	-200°C/-328°F	1250°C/2282°F
<b>E</b>	-200°C/-328°F	350°C/662°F
<b>n</b>	0°C/32°F	1250°C/2282°F
<b>S</b>	0°C/32°F	1450°C/2642°F
<b>rt.d</b> (1°)	-200°C/-328°F	700°C/1292°F
<b>rt.d</b> (0.1°)	-128.8°C/-199.9°F	537.7°C/999.9°F
<b>420</b>	4mA/-999 units	20mA/9999 units
<b>0-5</b>	0V= (dc)/-999 units	5V= (dc)/9999 units

Table 4.5b - Setup Menu Prompts and Descriptions.

### Setup Menu

Parameter	Value	Range	Factory Default	Appears If:
<b>LDC</b>		0 to 4	0	
<b>ln</b>		<b>J</b> , <b>H</b> , <b>E</b> , <b>n</b> , <b>S</b> , <b>rt.d</b> , <b>rt.d</b> , <b>0-5</b> , <b>420</b>	<b>J</b>	DIP switch selectable.
<b>dEC</b>		0, 0.0, 0.00	0	<b>ln</b> is set to <b>0-5</b> or <b>420</b>
<b>C-F</b>		<b>C</b> or <b>F</b>	Dependent on <b>dFL</b>	<b>ln</b> is set to <b>J</b> , <b>H</b> , <b>E</b> , <b>n</b> , <b>S</b> , <b>rt.d</b> , or <b>rt.d</b>
<b>rL</b>		<b>rL</b> to <b>rh</b>	Input dependent	
<b>rh</b>		<b>rh</b> to <b>rL</b>	Input dependent	
<b>DE1</b>		<b>hE</b> or <b>CL</b>	<b>hE</b>	
<b>HSC</b>		1 to 55, 0.1 to 5.5, 0.01 to 0.55°C 1 to 99, 0.1 to 9.9, 0.01 to 0.99°F	2, 0.2, 0.02°C 3, 0.3, 0.03°F	
<b>DE2</b>		<b>Con</b> Control <b>PrA</b> Process alarm <b>Pr</b> Process with no alarm message <b>dEA</b> Deviation alarm <b>dE</b> Deviation with no alarm message <b>na</b> None	<b>Con</b>	
<b>HSR</b>		1 to 5555, 0.1 to 555.5, 0.01 to 55.55°C 1 to 9999, 0.1 to 999.9, 0.01 to 99.99°F	2, 0.2, 0.02°C 3, 0.3, 0.03°F	<b>DE2</b> is not set to <b>Con</b> or <b>na</b>
<b>LRE</b>		<b>LRE</b> or <b>nLRE</b>	<b>nLRE</b>	<b>DE2</b> is not set to <b>Con</b> or <b>na</b>
<b>SIL</b>		<b>On</b> or <b>OFF</b>	<b>OFF</b>	<b>DE2</b> is set to <b>dEA</b> or <b>dE</b>
<b>rt.d</b>		<b>JIS</b> or <b>d in</b>	<b>d in</b>	<b>ln</b> is set to <b>rt.d</b> or <b>rt.d</b>
<b>rP</b>		<b>SEr</b> Ramping on power up <b>On</b> Ramping to set point at all times <b>OFF</b> None	<b>OFF</b>	
<b>rt</b>		0 to 9999	100°/hr	<b>rP</b> is not set to <b>OFF</b>
<b>PL</b>		0 to 100	100	<b>DE1</b> or <b>DE2</b> is set to <b>hE</b>
<b>dSP</b>		<b>nor</b> normal <b>SEt</b> Set Point (lower only) <b>Pro</b> Process (upper only)	<b>nor</b>	

Setup

# Operation Menu

## Entering the Operation Menu

The Operation Menu contains parameters that determine how the controller will control and operate. These are parameters that users may need to change from time to time. The Operation Menu is entered by pressing the Advance key. The setting of the **LOC** parameter will affect the ability to access this menu.

Figure 4.6 -  
The Operation Menu.

**NOTE:**

The upper display will always return to the process value after 1 minute without key strokes.

**NOTE:**

Shaded parameters may not appear, depending on the controller's configuration and model number.

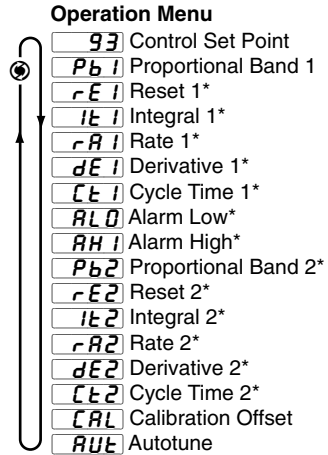

\* Parameter may not always appear.

## Operation Parameters

**Proportional Band 1 and 2:** A proportional band, expressed in degrees or % of span, within which a proportioning function is active for Output 1 or 2. When **Pb1** is set to 0, the unit functions as an on-off control on Output 1 and 2. **Pb2** will not appear if **Pb1** is set to 0 or **DE2** is not set to **Con**. The switching differential is determined by the **HSC** parameter.

**Range** if **DFL** is set to **US**: **Pb1**: 0 to 555°C/0 to 999°F/0 to 999 Units; 0.0 to 55.5°C/0.0 to 99.9°F/0.0 to 99.9 units, **Pb2**: The same as **Pb1** except lower limit is 1 or 0.1. **Defaults:** **Pb1** is set to 25°F/2.5°F. **Pb2** is set to 25.

**Range** if **DFL** is set to **SI**: 0 to 999.9% of span

**Defaults:** **Pb1** is set to 3.0% **Pb2** is set to 3.0%

**Reset/Integral 1 and 2:** An integral control action for Output 1 or 2 that automatically eliminates offset, or "droop," between set point and actual process temperature. **rE1**/ **It1**: Will not appear if **Pb1** is set to 0. **rE2**/ **It2**: Appears if **Pb1** is not set to 0 and **DE2** is set to **Con**. Either reset **rE** or integral **It** will appear depending on how the **DFL** parameter is set in the Calibration Menu. See the Appendix.

**Range** if **DFL** is set to **US**: 0 to 9.99 repeats/minute **Default:** 0.00

**Range** if **DFL** is set to **SI**: 00.1 to 9.99 minutes per repeat **Default:** 0.00

**Rate/Derivative 1 and 2:** The rate (derivative) function for Output 1 or Output 2.

Eliminates overshoot on startup, or after the set point changes. **rA1**/ **dE1**: Will not appear if **Pb1** is set to 0. **rA2**/ **dE2**: Appears if **Pb1** is not set to 0 and **DE2** is set to **Con**. Either rate **rA** or derivative **dE** appears depending on how **DFL** is set in the Calibration Menu.

**Range** if **DFL** is set to **US** or **SI**: 0 to 9.99 minutes **Default:** 0.0

**Cycle Time 1 and 2:** Time for a controller to complete one time-proportioned cycle for Output 1 or Output 2; expressed in seconds. **CE1**: Will not appear if **Pb1** is set to 0, or Output 1 is 4-20mA. **CE2**: Will not appear if **Pb1** is set to 0 or **DE2** is not set to **Con**.

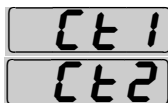
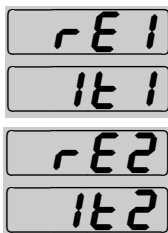
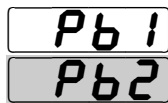



**If a mechanical relay or contactor is switching power to the load, a longer cycle time may be desirable to minimize wear on the mechanical components. Typical life of a mechanical relay is 100,000 cycles.**  
**Range:** 0.1 to 999.9 seconds      **Default:** 5.0 seconds

**ALD**

**Alarm Low:** Represents the low process alarm or low deviation alarm. This parameter will not appear if  **DL2** is set to no or  **Con**.  
**Range** if  **DL2** is set to  **dEA** or  **dE**: -999 to 0      **Default:** -999  
**Range** if  **DL2** is set to  **PrA** or  **Pr**:  **rL** to  **AH1**      **Default:**  **rL**

**AH1**

**Alarm High:** Represents the high process alarm or high deviation alarm. This parameter will not appear if  **DL2** is set to  **no** or  **Con**.  
**Range** if  **DL2** is set to  **dEA** or  **dE**: 0 to 999      **Default:** 999  
**Range** if  **DL2** is set to  **PrA** or  **Pr**:  **ALD** to  **rH**      **Default:**  **rH**

**CAL**

**Calibration Offset:** Adds or subtracts degrees from the input signal.  
**Range:** -100°C to 100°C/-180°F to 180°F/-180 units to 180 units; or  
-10.0°C to 10.0°C/-18.0°F to 18.0°F      **Default:** 0

**AUT**

**Autotune:** Initiates an autotune.  
**Range:** 0 is set to off, 1 is set to slow, 2 is set to medium, 3 is set to fast  
**Default:** 0

**Table 4.7 -  
Operation Menu  
Prompts and  
Descriptions.**

### Operation Menu

Document your Series 93 Operation Parameters in the Value column below. Do not mark any values here; make photocopies instead.

Operation Parameters	Value	Range	Factory Default
<input type="checkbox"/> <b>Pb1</b>		If <input type="checkbox"/> <b>dFL</b> is set to <input type="checkbox"/> <b>US</b> : 0 to 555°C/0 to 999°F/0 to 999 Units 0 to 55.5°C/0 to 99.9°F/0 to 99.9 Units 0 is control. <input type="checkbox"/> <b>HSC</b> is set to switch differential If <input type="checkbox"/> <b>dFL</b> is set to <input type="checkbox"/> <b>SI</b> : 0.0 to 999.9% of span	25°F 2.5°F 3%
<input type="checkbox"/> <b>rE1</b>		0.00 to 9.99 repeats/minute 0.00 = No Reset. Won't appear if <input type="checkbox"/> <b>Pb1</b> is set to 0 or <input type="checkbox"/> <b>dFL</b> is set to <input type="checkbox"/> <b>SI</b> .	0.00 repeats/minute
<input type="checkbox"/> <b>IE1</b>		0.0 to 99.9 minutes/repeat. 0.00 = No Integral. Won't appear if <input type="checkbox"/> <b>Pb1</b> is set to 0 or <input type="checkbox"/> <b>dFL</b> is set to <input type="checkbox"/> <b>US</b> .	00.0 minutes/repeat
<input type="checkbox"/> <b>rA1</b>		0.00 to 9.99 minutes 0.00 = No Rate. Will not appear if <input type="checkbox"/> <b>Pb1</b> is set to 0 or <input type="checkbox"/> <b>dFL</b> is set to <input type="checkbox"/> <b>SI</b> .	0.00 minutes
<input type="checkbox"/> <b>dE1</b>		0.00 to 9.99 minutes. 0.00 = No Derivative. Won't appear if <input type="checkbox"/> <b>Pb1</b> is set to 0 or <input type="checkbox"/> <b>dFL</b> is set to <input type="checkbox"/> <b>US</b> .	0.00 minutes
<input type="checkbox"/> <b>CE1</b>		0.1 to 999.9 Won't appear if <input type="checkbox"/> <b>Pb1</b> is set to 0, or <input type="checkbox"/> <b>420</b> .	5.0 seconds
<input type="checkbox"/> <b>Pb2</b>		Same as <input type="checkbox"/> <b>Pb1</b> . <input type="checkbox"/> <b>Pb2</b> lower limit = 1, 0.1, 0.01	
<input type="checkbox"/> <b>rE2</b>		Same range as <input type="checkbox"/> <b>rE1</b> .	
<input type="checkbox"/> <b>IE2</b>		Same range as <input type="checkbox"/> <b>IE1</b> .	
<input type="checkbox"/> <b>rA2</b>		Same range as <input type="checkbox"/> <b>rA1</b> .	
<input type="checkbox"/> <b>dE2</b>		Same range as <input type="checkbox"/> <b>dE1</b> .	
<input type="checkbox"/> <b>CE2</b>		Same range as <input type="checkbox"/> <b>CE1</b> .	
<input type="checkbox"/> <b>ALD</b> Deviation <input type="checkbox"/> <b>dE</b> Process <input type="checkbox"/> <b>Pr</b>		-999 to 0 <input type="checkbox"/> <b>rL</b> to <input type="checkbox"/> <b>AH1</b> Will not appear if <input type="checkbox"/> <b>DL2</b> is set to <input type="checkbox"/> <b>no</b> or <input type="checkbox"/> <b>Con</b> .	-999 <input type="checkbox"/> <b>rL</b>
<input type="checkbox"/> <b>AH1</b> Deviation <input type="checkbox"/> <b>dE</b> Process <input type="checkbox"/> <b>Pr</b>		0 to 999 <input type="checkbox"/> <b>ALD</b> to <input type="checkbox"/> <b>rH</b> Will not appear if <input type="checkbox"/> <b>DL2</b> is set to <input type="checkbox"/> <b>no</b> or <input type="checkbox"/> <b>Con</b> .	999 <input type="checkbox"/> <b>rH</b>
<input type="checkbox"/> <b>CAL</b>		±100°C/±180°F/±180 Units	0
<input type="checkbox"/> <b>AUT</b>		0 to 3	0

Setup

# Notes

# 5

## How to Tune and Operate the Series 93

### Autotuning (Heat and/or Cool)

The Series 93 can automatically tune the PID parameters to fit the characteristics of your particular thermal system.

The autotuning procedure operates on a thermal response value — slow, medium, or fast. Use the slow thermal response when your process does not need to reach the set point too rapidly, or if it usually does not often exceed the set point. A fast thermal response produces a rapid temperature change over a short period of time.

Once the autotune sequence has begun, the Output 1 heat proportional band is set to 0 and the control goes into an on-off mode of control at 90% of the established set point. The displayed set point remains unchanged.

Once the controller finishes "learning" the system, it returns to a standard PID control with the PID values automatically set as a result of autotuning. Autotune does not change cycle time parameters. The controller can also be manually tuned. See the next page for instructions on how to manually tune the controller. Any change of the set point, while in autotune, re-initiates the autotune procedure.

**NOTE:**

Set the **HSC** parameter under the Setup Menu to 2°C/3°F before autotuning your controller.

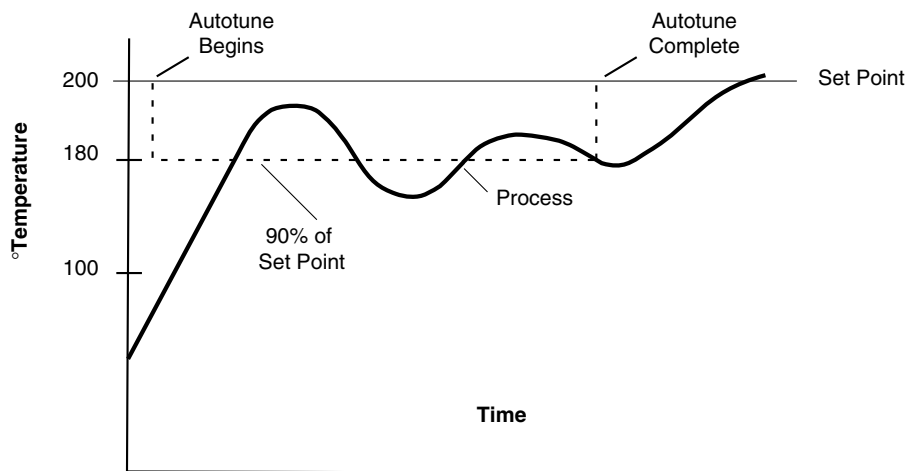

Figure 5.1 -  
Autotuning at a Set  
Point of 200°F.

In order for the Series 93 to successfully complete the autotune, the process must cross 90% of the set point four times within 80 minutes after the autotune has started. If this does not happen within the 80-minute time limit, the **Pb** remains at 0 and the controller functions in an on-off mode.

To start autotuning:

1. Press the **ⓂAdvance** key until the **AUT** prompt appears in the data display.
2. Select a thermal response value using the **⬆Up-arrow/⬇Down-arrow** keys: 1 for a slow response, 2 for an average response and 3 for a system that responds quickly. A thermal response value of 2 satisfactorily tunes most thermal systems.
3. Press the **ⓂAdvance** key. While the controller is in the tuning mode, the lower display alternately displays the normal information and the prompt **AUT**, at one-second intervals.

4. When tuning is complete, the displays return to their previous state and  $\boxed{AUE}$  reverts to 0. The Series 93 installs appropriate PID tuning parameters and saves them in the non-volatile memory. **If a mechanical relay or contactor is switching power to the load, a longer cycle time may be desirable to minimize wear on the mechanical components. Typical life of a mechanical relay is 100,000 cycles.**

**To abort autotuning** either reset the  $\boxed{AUE}$  parameter to 0, press the  $\infty$  Infinity key twice, or cycle power off and on. In all cases, aborting autotune restores all values to those previous to autotuning.

## Manual Tuning

For optimum controller performance, tune the Series 93 to your thermal system. The tuning settings here are for a broad spectrum of applications; your system may have somewhat different requirements. **NOTE: This is a slow procedure, taking from minutes to hours to obtain optimum value.**

### NOTE:

Tune heating outputs at a set point above ambient temperature.

Tune cooling outputs at a set point below ambient temperature.

1. **Apply power to the Series 93** and enter a set point. Set Operation parameters as follows:  $\boxed{Pb}$  to  $\boxed{1}$ ,  $\boxed{rE}$  /  $\boxed{IE}$  to  $\boxed{0.00}$ ,  $\boxed{rA}$  /  $\boxed{dE}$  to  $\boxed{0.00}$ ,  $\boxed{CT}$  to  $\boxed{5.0}$ ,  $\boxed{CAL}$  to  $\boxed{0}$ ,  $\boxed{AUE}$  to  $\boxed{0}$ .

2. **Proportional Band Adjustment:** Gradually increase  $\boxed{Pb}$  until the upper display temperature stabilizes to a constant value. The process temperature will not be right on set point because the initial reset value is 0.00 repeats per minute. (When  $\boxed{Pb}$  is set to 0;  $\boxed{rE}$  /  $\boxed{IE}$  and  $\boxed{rA}$  /  $\boxed{dE}$  are inoperative, and the Series 93 functions as a simple on-off controller.) The  $\boxed{HSC}$  parameter determines the switching differential value.

3. **Reset/Integral Adjustment:** Gradually increase  $\boxed{rE}$ , or decrease  $\boxed{IE}$  until the upper display temperature begins to oscillate or "hunt." Then slowly decrease  $\boxed{rE}$  or increase  $\boxed{IE}$  until the upper display stabilizes again near the set point.

4. **Cycle Time Adjustment:** Set  $\boxed{CT}$  as required. Faster cycle times sometimes achieve the best system control. However, if a mechanical contactor or solenoid is switching power to the load, a longer cycle time may be desirable to minimize wear on the mechanical components. Experiment until the cycle time is consistent with the quality of control you want.  $\boxed{CT}$  will not appear on units with a process output.

5. **Rate/Derivative Adjustment:** Increase  $\boxed{rA}$  /  $\boxed{dE}$  to 1.00 minute. Then raise the set point by 11° to 17°C, or 20° to 30°F. Observe the system's approach to the set point. If the load temperature overshoots the set point, increase  $\boxed{rA}$  /  $\boxed{dE}$  to 2.00 minutes.

Raise the set point by 11 to 17°C, or 20 to 30°F and watch the approach to the new set point. If you increase  $\boxed{rA}$  /  $\boxed{dE}$  too much, the approach to the set point is very sluggish. Repeat as necessary until the system rises to the new set point without overshooting or approaching the set point too slowly.

6. **Calibration Offset Adjustment:** You may want your system to control to a temperature other than the value coming from the input sensor. If so, measure the difference between that temperature (perhaps at another point in the system) and the process value showing in the upper display. Then enter the calibration offset value you want. Calibration offset adds or subtracts degrees from the value of the input signal.

## Manual and Automatic Operation

To change from auto to manual operation, press the  $\infty$  Infinity key twice.

Manual operation provides open loop control of the outputs from a range of -100% (full cooling) to 100% (full heating) power. The Series 93 allows a negative output value only when  $[O\%]$  is set to  $[Con]$ . Automatic operation provides closed-loop on-off or PID control. When the operator transfers from a closed-loop to an open loop, the Series 93 retains the power level from the closed-loop control, referred to as bumpless transfer. When the Series 93 returns to closed-loop control, it restores the previous set point temperature.

The percent indicator light indicates auto or manual operation. When the percent indicator light is on, the control is in manual operation and displays the percent power value in the lower display. When the percent indicator light is off, it is in automatic operation. Press the  $\infty$  Infinity key to flash the percent indicator light. Press the  $\infty$  Infinity key again to complete the manual/automatic change.

When a sensor opens, the Series 93 switches from automatic to manual operation if  $[LOC]$  is set to 0, 1 or 2.

- If  $[LOC]$  is set to 0, 1 or 2 and the bumpless transfer conditions are met, the Series 93 switches to manual operation at the last automatic power level. The bumpless transfer conditions are: the process has stabilized within a  $\pm 5\%$  power level for at least two minutes prior to sensor break provided the power level is less than 75%.
- If  $[LOC]$  is set to 3 or 4, the Series 93 switches into manual operation at 0% power (outputs disabled).

When transferring from auto to manual operation, the controller output(s) remains stable ("bumpless," smooth transition). When transferring from manual to automatic operation, the controller output(s) may change significantly. In manual operation, the percent output power set point appears in the lower display; in automatic operation, the control set point appears.

### NOTE:

**A process input does not have sensor break protection or bumpless transfer. Outputs selected as  $[ht]$  (reverse acting) will be full on if a sensor break occurs.**

## Setting the Control Set Point

The set point sets the operating set point for the control output(s). It represents the process value the system tries to achieve. The control set point value is displayed in the lower display window while in the auto mode of operation. The set point can be incremented or decremented without pressing the  $\infty$  Advance key. The lower display may be blank if  $[dSP]$  is set to  $[Pro]$ . In ramping mode, the lower display alternately flashes the desired end set point and  $[rP]$ . The setting of the  $[LOC]$  parameter can limit the ability to change the set point.

To change the set point, press either the  $\uparrow$  Up-arrow/ $\downarrow$  Down-arrow keys to increment or decrement the set point value. Any change will automatically be entered after three seconds.

# Using Alarms

The Series 93 has two alarm types, process and deviation.

A **process alarm** sets an absolute temperature. When the process exceeds that absolute temperature limit an alarm occurs. The process alarm set points may be independently set high and low. Under the Setup Menu, select the type of alarm output with the  **DE2** parameter.  **PrA** sets a process alarm with an alarm message displayed.  **Pr** sets a process alarm with no alarm message displayed.

## NOTE:

When the alarm output is de-energized, the N.O. contact is open in the alarm condition. The N.C. contact is closed in the alarm condition.

A **deviation alarm** alerts the operator when the process strays too far from the set point. The operator can enter independent high and low alarm settings. The reference for the deviation alarm is the set point. Any change in set point causes a corresponding shift in the deviation alarm.  **dEA** sets a deviation alarm with an alarm message displayed.  **dE** sets a deviation alarm with no alarm message displayed.

**Example:** If your set point is 100°F, and a deviation alarm is set at +7°F as the high limit, and -5°F as the low limit, the high alarm trips at 107°F, and the low alarm at 95°F. If you change the set point to 130°F, the alarms follow the set point and trip at 137°F and 125°F.

**Latching:** Both process and deviation alarms can be latching or non-latching. When the alarm condition is removed a **non-latching alarm automatically** clears the alarm output. You must **manually clear a latching alarm** before it will disappear.

Flashing  **LO** or  **HI** in the lower display indicates an alarm when  **DE2** is set to  **PrA** or  **dEA**. The lower display alternately shows information from the current parameter and the  **LO** or  **HI** alarm message at one-second intervals. The alarm output is de-energized and the Output 2 indicator light is lit.

## To clear an alarm...

- First correct the alarm condition, then...
  - **If the alarm is latching...**  
Clear it manually; press the  Infinity key once as soon as the process temperature is inside the  **HSA** parameter alarm limit.
  - **If the alarm is non-latching...**  
The alarm clears itself automatically as soon as the process temperature is inside the  **HSA** parameter alarm limit.

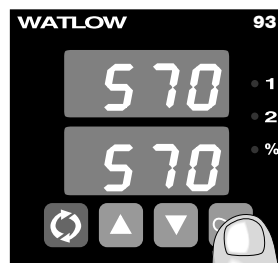

Press once -  
Clear a latched  
and corrected  
alarm.

Figure 5.4 -  
Clearing an Alarm.

**Alarm Silencing** is available with the deviation alarm and has two uses:

When  **SIL** is selected as "on," the operator must manually disable the alarm by pressing the  Infinity key once on initial power up (in either the latching or non-latching mode). Alarm silencing disables the alarm output relay. However, the Output 2 indicator light (also the lower display when  **DEL** is set to  **DER**) shows an alarm condition until the process value is within the "safe" region of the deviation alarm band. Once the process value crosses into the "safe" region, both a latching or a non-latching alarm is ready. Any future deviation outside this safe band triggers an alarm.

## Error Code Messages

**NOTE:**

An alarm display will be masked by an error condition or when the controller is in the Calibration or Setup Menus.

Four dashes  **---** in the upper display indicate a Series 93 error. The error code is visible in the lower display.

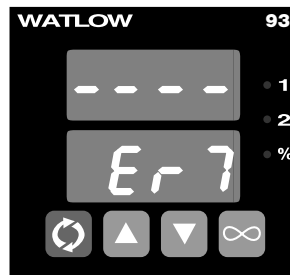

Figure 5.5 - Error Code Message.



**CAUTION:**

Electrical noise or a noise event, vibration or excess environmental moisture or temperature may cause Series 93 errors to occur. If the cause of an error is not otherwise apparent, check for these.

**Er 2** - Sensor underrange error (applies only to RTD units)

The sensor input generated a value lower than the allowable signal range, or the analog-to-digital circuitry malfunctioned. Enter a valid input. Make sure the  **In** parameter (Setup Menu) and the DIP switch settings both match your sensor.

**Er 4** - Configuration error

The controller's microprocessor is faulty; call the factory.

**Er 5** - Nonvolatile checksum error

The nonvolatile memory checksum discovered a checksum error. Unless a momentary power interruption occurred while the controller was storing data, the nonvolatile memory is bad. Call the factory.

**Er 6** - Analog-to-digital underflow error

The analog-to-digital circuit is underrange. An open or reversed polarity sensor is the most likely cause. Check the sensor; if the connection is good and functions properly, call the factory. The analog-to-digital underrange voltage is too low to convert an analog-to-digital signal. Make sure the  **In** parameter (Setup Menu) matches your sensor and the DIP switches are set accordingly.

**Er 7** - Analog-to-digital overflow error

The analog-to-digital circuit is overrange. An open or reversed polarity sensor is the most likely cause. Check the sensor; if the connection is good, and the sensor functions properly, call the factory. The analog-to-digital overrange voltage is too high to convert an analog-to-digital signal. Make sure the  **In** parameter (Setup Menu) matches your sensor and the DIP switches are set accordingly.

# Error Code Actions

- **Er2, Er6, Er7 result in these conditions:**

- **If LDC Lock is set to 0, 1 or 2:**

...and the controller was in automatic operation when the error occurred, it goes into manual (% power) operation. If the output power is less than 75% power, and a <5% change in power occurred within the last two minutes, the Series 93 switches into manual operation at the last automatic power level (bumpless transfer). If the controller was in manual operation, it remains there. Press the ∞Infinity key twice to see the error code. The alarm output (if present) is in its alarm state (indicator lit). The upper display reads - - -. The lower display indicates the error code if the ∞Infinity Key is pressed twice.

If the controller was operating with stable output values when the error occurred, it continues to operate at those levels on a % power basis. If output values were not stable, the control outputs go to 0% power (off).

- **If LDC Lock is set to 3 or 4:**

The controller remains in automatic operation and the outputs turn off. The ∞Infinity and ∞Advance keys are inactive. The ↑Up-arrow/↓Down-arrow keys may be pressed simultaneously to enter the Setup Menu. The alarm output (if present) is in its alarm state (indicator light lit). The upper display reads - - -. The lower display indicates the error code if the ∞Infinity key is pressed.

- **To clear a corrected error...**

- Press the ∞Advance key or turn the controller off and on.

- **Er4 and Er5 result in these conditions:**

- The controller is in automatic operation with both outputs off.
- The alarm output, if present, are in their alarm state (de-energized with the indicator lit).
- The upper display indicates the process value.
- The lower display indicates the error code.
- All keys are inactive.
- All Setup Menu parameters return to default values.
- The above conditions occur regardless of the value of LDC, or the presence of the Setup or Calibration Menus.

- **To clear a corrected error...**

- Turn the controller off and on.



## Noise and Installation Guidelines

For wiring guidelines, refer to the IEEE Standard No. 518-1982, available from IEEE, Inc. 345 East 47th Street, New York, NY 10017.

### Noise Sources

- Switches and relay contacts operating inductive loads such as motors, coils, solenoids, and relays, etc.
- Thyristors or other semiconductor devices which are not zero crossover-fired (randomly-fired or phase angle-fired devices).
- All welding machinery and heavy current carrying conductors.
- Fluorescent and neon lights.

### Decreasing Noise Sensitivity

- Physical separation and wire routing must be given careful consideration in planning the system layout. For example, ac power supply lines should be bundled together and physically kept separate from input signal lines (sensor lines). A 305-mm (12-inch) minimum separation is usually effective. Keep all switched output signal lines (high power level) separate from input signal lines (sensor lines). Cross other wiring at 90° angles whenever crossing lines is unavoidable.
- Look at the system layout; identify and locate electrical noise sources such as solenoids, relay contacts, motors, etc. Route the wire bundles and cables as far away as possible from these noise sources. Don't mount relays or switching devices close to a microprocessor controller. Don't have phase angle-fired devices in the same electrical enclosure or on the same power line with the controller.
- Shielded cables should be used for all low power signal lines to protect them from magnetic and electrostatic coupling of noise. Some simple pointers are:
  - ◇ Whenever possible, run low-level signal lines unbroken from signal source to the controller circuit.
  - ◇ Connect the shield to the controller circuit common at the controller end only. Never leave the shield unconnected at both ends. Never connect both shield ends to a common or ground.
  - ◇ Maintain shield continuity at daisy chain connection points by reconnecting the broken shield.
  - ◇ Assume no electrostatic shielding when using the shield as a signal return. If you must do this, use triaxial cable (electrostatically shielded coaxial cable).

- Use twisted pair wire any time controller circuit signals must travel more than two feet, or when you bundle them in parallel with other wires.
- Select the size or gauge of wire by calculating the maximum circuit current and choosing the gauge meeting that requirement. Using greatly larger wire sizes than required generally increases the likelihood of electrostatic (capacitance) coupling of noise.
- Eliminate ground loops in the entire controller system. You can spot the obvious loops by studying the "as-built" wiring diagram. There are also not-so-obvious ground loops resulting from connecting internal circuit commons in the manufacturer's equipment.
- Do not daisy chain ac power (or return) lines, or output signal (or return) lines to multiple controller circuits. Use a direct line from the power source to each input requiring ac power. Avoid paralleling L1 (power lead) and L2 (return lead) to load power solenoids, contactors, and controller circuits. If an application uses L1 (power lead) to switch a load, L2 (return lead) has the same switched signal and could couple unwanted noise into a controller circuit.
- Tie all ground terminals together with one lead (usually green wire) tied to ground at one point. Don't connect the ground to the controller case if the controller is in a grounded enclosure (preventing ground loops).
- Do not confuse chassis grounds (safety ground) with controller circuit commons or with ac supply L2 (return or neutral line). Each return system wiring must be separate. Absolutely never use chassis ground (safety) as a conductor to return circuit current.

## Eliminating Noise

- Use "snubbers" (QUENCHARC™ P/N: 0804-0147-0000) to filter out noise generated by relays, relay contacts, solenoids, motors, etc. A snubber is a simple filter device using a 0.1µf, 600 volt, non-polarized capacitor in series with a 100Ω, 1/2 watt resistor. The device can be used on ac or dc circuits to effectively dampen noise at its source. Refer to output wiring in Chapter Two for proper Quencharc installation.
- The ultimate protection is an "uninterruptable" power supply. This "senses" the ac power line; when the line fluctuates, a battery-powered 60Hz inverted circuit takes over, supplying power within one-half to one cycle of the ac line.

# Calibration

Before attempting to calibrate, make sure you read through the procedures carefully and have the proper equipment called for in each procedure. Make sure the DIP switches are in the proper position for the input type. See Chapter Four.

## Entering the Calibration Menu

In the Calibration Menu, various input signals must be supplied for the controller to go through its auto calibration. The Calibration Menu can only be entered from the  Lock parameter in the Setup Menu. Press the /  keys simultaneously for 3 seconds ( $\pm 1$  second). The  parameter appears in the lower display with "no" in the upper display.

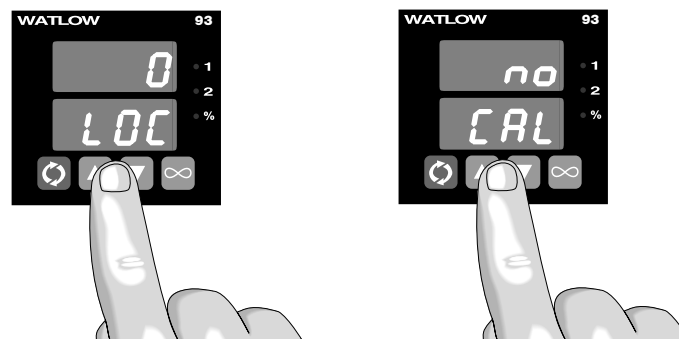

Figure A.3 - Entering the Calibration Menu.

**NOTE:**  
Calibration values will not be retained unless you are in the MANUAL mode. Do not enter the MANUAL mode until you are at the correct input parameters.

**NOTE:**  
While in the Calibration Menu, the controller output(s) go off and the alarm output (if present) is on.

Any inadvertent change in the displayed data, when pressing the /  keys, is ignored. Calibration values won't be retained unless you are in the manual mode. Press the  or  key to change the upper display to . Press  to enter the calibration sequence.

Upon entering the calibration menu, the upper display window indicates . It continues to indicate  (with the exception of calibration of the 4-20mA output) while the operator walks through the entire calibration parameter list. While calibrating the 4-20mA output, the upper display contains a numeric value to be slewed up or down until the output value is correct. The controller uses the lower display to prompt the user as to what the input should be.

With the  parameter, select either  (System International) and the displayed parameters are °C, integral, derivative and proportional band in % of span. Or select  parameters which include displaying °F, rate, reset and proportional band in degrees or units.

Once the information has been properly established and maintained for at least 5 to 10 seconds, the  key may then be used to display the next prompt. After the final input is established, press the  key twice to return the controller to the configuration menu at the top of the parameter list.

# Restoring Factory Calibration

The **r5E** parameter restores the factory calibration values to the Series 93. If you calibrate your controller incorrectly, you have the option to default to the original values. Once you leave the **CAL** menu, the values are entered.

1. Press the **Up-arrow/Down-arrow** keys simultaneously for three seconds. The LOC parameter appears in the lower display. Continue holding the **Up-arrow/Down-arrow** keys until the lower display reads **CAL**.
2. Press the **Up-arrow** key until **YES** appears in the upper display.
3. **Advance** through the Calibration Menu until **r5E** appears in the lower display.
4. Press the **Up-arrow** key until **YES** appears in the upper display.
5. Press the **Advance** key and the Series 93 advances to test the displays.
6. To conclude, wait 60 seconds or press the **Advance** key to reach the next prompt or to exit from the CAL menu.

**This procedure is used only to restore calibration, it is not meant to clear values.**

# Calibration Menu

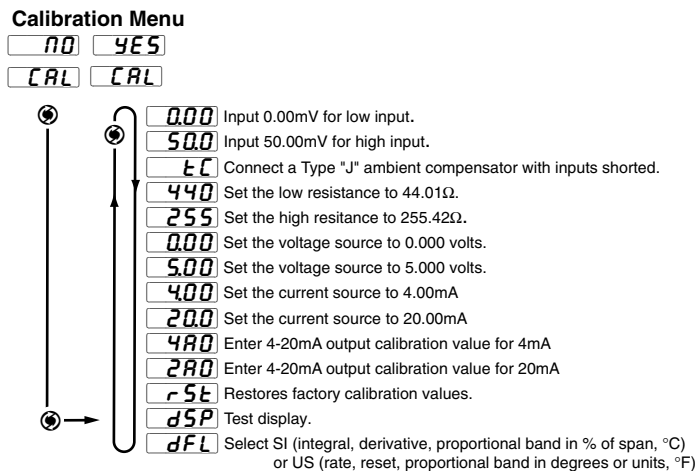

**Figure A.4 - Calibration Parameters.**



**Before attempting to calibrate, make sure you have the proper equipment called for in each procedure.**

**The Series 93 is calibrated and tested before leaving the factory.**

# Thermocouple Field Calibration Procedure

## NOTE:

Before calibrating an installed controller, make sure all data and parameters are documented. See the Setup and Operation Tables in Chapter Four.

## Equipment Required

- Type "J" Reference Compensator with reference junction at 0°C/32°F, or Type "J" Thermocouple Calibrator set at 0°C/32°F.
- Precision millivolt source, 0-50mV min. range, 0.01mV resolution

## Setup And Calibration

1. Connect the ac line voltage L1 and L2 to the proper terminals.
2. Connect the millivolt source to Terminal 5 Negative and Terminal 3 Positive on the Series 93 terminal strip. Use regular 20 - 24 gauge wire. Make sure the DIP switch is set for thermocouple input. See Chapter Four.
3. Apply power to the controller and allow it to warm up for 15 minutes. **After warm-up** put the controller in the Calibration Menu. See Figure A.3. Select .
4. Press the  $\infty$  Infinity key twice to enter the manual mode. The controller is calibrating when % indicator light is on. Make sure the controller is in manual mode only when you are in the correct parameters.
5. At the 0.00 prompt, enter 0.00mV from the millivolt source to the controller. Allow at least 10 seconds to stabilize. Press the  $\rightarrow$  Advance key.
6. At the 50.0 prompt, enter 50.00mV from the millivolt source to the Series 93. Allow at least 10 seconds to stabilize. Press the  $\rightarrow$  Advance key.
7. At the  prompt, disconnect the millivolt source, and connect the reference compensator or thermocouple calibrator to Terminal 5 Negative, and Terminal 3 Positive on the Series 93 terminal strip. If using a compensator, turn on and short the input wires. If using the "J" calibrator, set it to simulate 0°C/32°F. Allow 10 seconds for the controller to stabilize. The controller will leave the  mode if one minute passes between key activations. To conclude the thermocouple calibration, press the  $\infty$  Infinity key twice, then press the  $\rightarrow$  Advance key to reach the next prompt or to exit from the  menu.

# RTD Field Calibration Procedure

## NOTE:

When the % indicator light is on, the controller is automatically calibrating. Your sequence is VERY important. Always move to the next parameter before changing the calibration equipment.

## Equipment Required

- 1K $\Omega$  precision decade resistance box with 0.01 $\Omega$  resolution.

## Setup And Calibration

1. Connect the ac line voltage L1 and L2 to the proper terminals.
2. Connect the decade resistance box to Terminal 2, 3 and 5 on the terminal strip. Use regular 20 - 24 gauge wire of the same length and type. Make sure the DIP switch is set for RTD input, see Chapter Four.
3. Apply power to the controller and allow it to warm up for 15 minutes. **After warm-up** put the controller in the  menu. See Figure A.3. Select . Press the  $\rightarrow$  Advance key until the 440 prompt is displayed.
4. Press the  $\infty$  Infinity key twice to enter the manual mode. The controller is calibrating when the % indicator light is on. Make sure the controller is in manual mode only when you are in the correct parameters.
5. At the 440 prompt, set the decade resistance box to 44.01. Allow at least 10 seconds to stabilize. Press the  $\rightarrow$  Advance key.
6. At the 255 prompt, set the decade resistance box to 255.42. Allow at least 10 seconds to stabilize. Press the  $\infty$  Infinity key twice to exit the manual mode. The controller will leave the  mode if one minute passes between key activations. To conclude the RTD calibration, press the  $\infty$  Infinity key twice, then press the  $\rightarrow$  Advance key to reach the next prompt or to exit from the  menu.

# 0-5 Volt Input Field Calibration Procedure

## Equipment Required

- Precision dc voltage source 0-5 volt minimum range with 0.001 volt resolution.

## Setup and Calibration

1. Connect the ac line voltage L1 and L2 to the proper terminals on the Series 93.
2. Connect the voltage/current source to Terminal 3 (+) and 5 (-) on the Series 93 terminal strip. Use regular 20 - 24 gauge wire. Make sure the DIP switch is set for process input, see Chapter Four.
3. Apply power to the controller and allow it to warm up for 15 minutes. **After warm-up** put the controller in the  menu. See Figure A.3. Select . Press the  Advance key until 0.00 is displayed.
4. Press the  Infinity key twice to enter the manual mode. The controller is calibrating when the % indicator light is on. Make sure the controller is in the manual mode **only** when you are in the correct parameters.
5. At the 0.00 parameter, set the voltage source to 0.000 volts. Allow at least 10 seconds to stabilize. Press the  Advance key.
6. At the 5.00 parameter, set the voltage source to 5.000V<sub>DC</sub> (dc). Allow at least 10 seconds to stabilize. The controller leaves the  mode if 1 minute passes between key activations. Press the  Infinity key twice to exit the manual mode. To conclude the 0-5 volt calibration, press the  Infinity key twice, then press the  Advance key to reach the next prompt or to exit from the  menu.

### NOTE:

Before calibrating an installed controller, make sure all data and parameters are documented. See the Setup and Operation Tables in Chapter Four .

# 4-20mA Input Field Calibration Procedure

## Equipment Required:

- Precision current source 0-20mA minimum range with 0.01mA resolution.

## Setup and Calibration

1. Connect the ac line voltage L1 and L2 to the proper terminals on the Series 93.
2. Connect the current source to Terminal 2 (-) and 5 (+) on the Series 93 terminal strip. Use regular 20 - 24 gauge wire. Make sure the DIP switch is set for process input, see Chapter Four.
3. Apply power to the controller and allow it to warm up for 15 minutes. **After warm-up** put the controller in the  menu. See Figure A.3. Select YES. Press the  Advance key until 4 is displayed.
4. Press the  Infinity key twice to enter the manual mode. The controller is calibrating when the % indicator light is on. Make sure the controller is in the manual mode **only** when you are in the correct parameters.
5. At the 4.00 parameter, set the current source to 4.00mA. Allow at least 10 seconds to stabilize. Press the  Advance key.
6. At the 20.0 parameter, set the current source to 20.00mA. Allow at least 10 seconds to stabilize. The controller leaves the  mode if 1 minute passes between key activations. Press the  Infinity key twice to exit the manual mode. To conclude, press the  Infinity key twice, then press the  Advance key to reach the next prompt or to exit from the  menu.

### NOTE:

When the % indicator light is on, the controller is automatically calibrating. Your sequence is VERY important. Always move to the next parameter before changing the calibration equipment.

# 4-20mA Output Field Calibration Procedure

## Equipment Required:

- 300Ω, 1/2 watt 10% resistor.
- 4 - 1/2 digit Digital Multimeter.

## NOTE:

Before calibrating an installed controller, make sure all data and parameters are documented. See the Setup and Operation Tables in Chapter Four.

## NOTE:

When the % indicator light is on, the controller is automatically calibrating. Your sequence is VERY important. Always move to the next parameter before changing the calibration equipment.

## Setup And Calibration

1. Connect the ac line voltage L1 and L2 to the proper terminals of the Series 93. See Chapter Two. Set the multimeter to measure current.
2. Connect the multimeter in series with the 300Ω resistor to Terminal 9 Positive and 10 Negative on the Series 93 terminal strip. Use regular 20 - 24 gauge wire.
3. Apply power to the controller and allow it to warm up for 15 minutes. **After warm-up** put the controller in the `[CAL]` menu. See Figure A.3. Select **YES**. Press the **⏩** Advance key until the 4A0 prompt is displayed.
4. Press the **∞** Infinity key twice to enter the manual mode. The controller is calibrating when the % indicator light is on.
5. At the `[4A0]` prompt, the multimeter should read approximately 4mA. Allow at least 10 seconds to stabilize.
6. Use the **⬆** Up-arrow/**⬇** Down-arrow keys (reverse acting) to adjust the reading on the multimeter for 3.85mA ± 0.10mA. Press the **⏩** Advance key.
7. At the `[2A0]` prompt, the multimeter should read approximately 20mA. Allow at least 10 seconds to stabilize. The controller will leave the `[CAL]` mode if one minute passes between key activations, except for 4-20mA units.
8. Use the **⬆** Up/**⬇** Down keys (reverse acting) to adjust the reading on the multimeter for 20.15mA ± 0.10mA.
9. To conclude the 4-20mA output calibration, press the **∞** Infinity key twice, then press the **⏩** Advance key to reach the next prompt or to exit from the `[CAL]` menu.

# Notes



# Glossary

## A

**alarm** A signal that indicates that the process has exceeded or fallen below the set or limit point. For example, an alarm may indicate that a process is too hot or too cold.

**alarm, deviation** Warns that a process has exceeded or fallen below a certain range around the set point. Alarms can be referenced at a fixed number of degrees, plus or minus, from set point.

**alarm hysteresis** A change in the process variable required to re-energize the alarm output.

**alarm silence** A feature that disables the alarm relay output.

**anti-reset** A control feature that inhibits automatic reset action outside the proportional band. Also called anti-reset windup.

**anti-reset windup** The feature of a PID temperature controller that prevents the integral (automatic reset) circuit from functioning when the temperature is outside the proportional band. This standard feature helps stabilize a system. Also called anti-reset.

**automatic prompts** Data entry points where a microprocessor-based controller asks the operator to enter a control value.

## B

**bumpless transfer** A smooth transition from auto (closed loop) to manual (open loop) operation. The control output(s) does not change during the transfer.

## C

**calibration offset** An adjustment to eliminate the difference between the indicated value and the actual process value.

**CE** A manufacturer's mark that demonstrates compliance with European Union (EU) laws governing products sold in Europe.

**CE-compliant** Compliant with the essential requirements of European directives pertaining to safety and/or electromagnetic compatibility.

**closed loop** A control system that uses a sensor to measure a process variable and makes decisions based on that input.

**cold junction** See junction, cold.

**cold junction compensation** Electronic means to

compensate for the effective temperature at the cold junction.

**compensation, ambient** The ability of an instrument to adjust for changes in the temperature of the environment and correct the readings. Sensors are most accurate when maintained at a constant ambient temperature. When temperature changes, output drifts.

**control action** The response of the control output relative to the error between the process variable and the set point. For reverse action (usually heating), as the process decreases below the set point, the output increases. For direct action (usually cooling), as the process increases above the set point, the output increases.

**cycle time** The time required for a controller to complete one on-off-on cycle. It is usually expressed in seconds.

## D - E

**default parameters** The programmed instructions that are permanently stored in the microprocessor software.

**derivative** The rate of change in a process variable. Also known as rate. See PID.

**derivative control (D)** The last term in the PID control algorithm. Action that anticipates the rate of change of the process, and compensates to minimize overshoot and undershoot. Derivative control is an instantaneous change of the control output in the same direction as the proportional error. This is caused by a change in the process variable (PV) that decreases over the time of the derivative (TD). The TD is in units of seconds.

**Deutsche Industrial Norm (DIN)** A set of technical, scientific and dimensional standards developed in Germany. Many DIN standards have worldwide recognition.

**deviation alarm** See alarm, deviation.

**DIN** See Deutsche Industrial Norm.

**direct action** An output control action in which an increase in the process variable causes an increase in the output. Cooling applications usually use direct action.

**display capability** In an instrument with digital display, the entire possible span of a particular parameter or value.

**droop** In proportional controllers, the difference between set point and actual value after the system stabilizes.

**duty cycle** The percentage of a cycle time in which the output is on.

## F - G

**Form A** A single-pole, single-throw relay that uses only the normally open (NO) and common contacts. These contacts close when the relay coil is energized. They open when power is removed from the coil.

**Form C** A single-pole, double-throw relay that uses the normally open (NO), normally closed (NC) and common contacts.

## H

**hysteresis** A change in the process variable required to re-energize the control or alarm output. Sometimes called switching differential.

## I

**integral** Control action that automatically eliminates offset, or droop, between set point and actual process temperature. See reset, automatic.

**integral control (I)** A form of temperature control. The I of PID. See integral.

**isolation** Electrical separation of sensor from high voltage circuitry. Allows use of grounded or ungrounded sensing element.

## J - K

**JIS** See Joint Industrial Standards.

**Joint Industrial Standards (JIS)** A Japanese agency that establishes and maintains standards for equipment and components. Also known as JISC (Japanese Industrial Standards Committee), its function is similar to Germany's Deutsche Industrial Norm (DIN).

**junction** The point where two dissimilar metal conductors join to form a thermocouple.

**junction, cold** Connection point between thermocouple metals and the electronic instrument. See reference junction.

**junction, reference** The junction in a thermocouple circuit held at a stable, known temperature (cold junction). Standard reference temperature is 32°F (0°C).

## L

**limit or limit control** A highly reliable, discrete safety device (redundant to the primary controller) that monitors and limits the temperature of the process, or a point in the process. When temperature exceeds or falls below the limit set point, the limit controller interrupts power

through the load circuit. A limit control can protect equipment and people when it is correctly installed with its own power supply, power lines, switch and sensor.

## M

**manual mode** A selectable mode that has no automatic control aspects. The operator sets output levels.

## N

**NEMA 4X** A NEMA specification for determining resistance to moisture infiltration and corrosion resistance. This rating certifies the controller as washable and corrosion resistant.

## O

**offset (process)** The difference in temperature between the set point and the actual process temperature. Offset is the error in the process variable that is typical of proportional-only control. See also droop.

**on/off** A method of control that turns the output full on until set point is reached, and then off until the process error exceeds the hysteresis.

**open loop** A control system with no sensory feedback.

**output** Control signal action in response to the difference between set point and process variable.

**overshoot** The amount by which a process variable exceeds the set point before it stabilizes.

## P - Q

**P control** Proportioning control.

**parallel circuit** A circuit configuration in which the same voltage is applied to all components, with current divided among the components according to their respective resistances or impedances.

**parameter** A variable that is given a constant value for a specific application or process.

**PD control** Proportioning control with derivative (rate) action.

**percent power control** Open loop control with output power set at a particular level.

**percent power limit** Restriction of output power to a predetermined level.

**PI control** Proportioning control with integral (automatic reset) action.

**PID Proportional, integral, derivative.** A control mode with three functions: proportional action dampens the system response, integral corrects for droop, and derivative prevents overshoot and undershoot.

**process variable** The parameter that is controlled or measured. Typical examples are temperature, relative humidity, pressure, flow, fluid level, events, etc. The high process variable is the highest value of the process range, expressed in engineering units. The low process variable is the lowest value of the process range.

**programmed display data** Displayed information that gives the operator the intended process information, such as intended set point, intended alarm limit, etc., corresponding to temperature.

**prompt** A symbol or message displayed by the controller that requests input from the user.

**proportional** Output effort proportional to the error from set point. For example, if the proportional band is 20° and the process is 10° below set point, the heat proportioned effort is 50 percent. The lower the PB value, the higher the gain.

**proportional band (PB)** A range in which the proportioning function of the control is active. Expressed in units, degrees or percent of span. See PID.

**proportional control** A control using only the P (proportional) value of PID control.

## R

**rate** Anticipatory action that is based on the rate of temperature change, and compensates to minimize overshoot and undershoot. See derivative.

**reference junction** See junction.

**reset** Control action that automatically eliminates offset, or droop, between set point and actual process temperature. Also see integral.

**reset, automatic** The integral function of a PI or PID temperature controller that adjusts the process temperature to the set point after the system stabilizes. The inverse of integral.

**reset windup inhibit** See anti-reset.

**resistance temperature detector (RTD)** A sensor that uses the resistance temperature characteristic to measure temperature. There are two basic types of RTDs: the wire RTD, which is usually made of platinum, and the thermistor, which is made of a semiconductor material. The wire RTD is a positive temperature coefficient sensor only, while the thermistor can have either a negative or positive temperature coefficient.

**reverse action** An output control action in which an

increase in the process variable causes a decrease in the output. Heating applications usually use reverse action.

**RTD** See resistance temperature detector.

## S

**set point** The desired value programmed into a controller. For example, the temperature at which a system is to be maintained.

**switching sensitivity** In on/off control, the temperature change necessary to change the output from full on to full off. See hysteresis.

## T - Y

**thermal system** A regulated environment that consists of a heat source, heat transfer medium or load, sensing device and a control instrument.

**thermocouple (t/c)** A temperature sensing device made by joining two dissimilar metals. This junction produces an electrical voltage in proportion to the difference in temperature between the hot junction (sensing junction) and the leadwire connection to the instrument (cold junction).

**thermocouple break protection** The ability of a control to detect a break in the thermocouple circuit and take a predetermined action.

**three-mode control** Proportioning control with integral (reset) and derivative (rate). Also see PID.

**time proportioning control** A method of controlling power by varying the on/off duty cycle of an output. This variance is proportional to the difference between the set point and the actual process temperature.

**triac** A solid state device that switches alternating current.

## Z

**zero cross** Action that provides output switching only at or near the zero-voltage crossing points of the ac sine wave. See burst fire.

**zero switching** See zero cross.

# Specifications

Specifications (2218)

## Control Mode

- Microprocessor-based, user-selectable control modes
- Single input, dual output
- 2.5Hz Input Sampling Rate
- 1Hz Display Update Rate
- Ramp to set point: 0 to 9999 degrees or units per hour
- Heat and cool autotune

## Operator Interface

- Sealed membrane front panel
- Dual, four-digit red or green displays
- Advance, Up-arrow, Down-arrow, and Infinity keys
- User-selectable screen display

## Accuracy

- Calibration accuracy and sensor conformity:  $\pm 0.1\%$  of span,  $\pm 1^\circ\text{C}$  @  $25^\circ\text{C} \pm 3^\circ\text{C}$  ( $77^\circ\text{F} \pm 5^\circ\text{F}$ ) ambient and rated line voltage
- Accuracy span:  $540^\circ\text{C}$  ( $1000^\circ\text{F}$ ) minimum
- Temperature stability:  $\pm 0.2^\circ\text{C}/^\circ\text{C}$  ( $\pm 0.2^\circ\text{F}/^\circ\text{F}$ ) rise in ambient maximum

## Sensors/Inputs

- Thermocouple, grounded or ungrounded sensors
- RTD 2- or 3-wire, platinum,  $100\Omega$  @  $0^\circ\text{C}$  calibration to DIN curve ( $0.00385\Omega/\Omega/^\circ\text{C}$ ) or JIS curve ( $0.003916\Omega/\Omega/^\circ\text{C}$ ); user-selectable
- Process, 4-20mA @  $5\Omega$ , or 0-5V $\approx$  (dc) @  $10\text{k}\Omega$  input impedance
- Sensor break protection de-energizes control output to protect system or selectable bumpless transfer to manual operation
- $^\circ\text{C}$  or  $^\circ\text{F}$  or process units display, user-selectable

## Input Range

Specified temperature ranges represent the controller's operational span.

### • Thermocouple

Type J	0	to	750 $^\circ\text{C}$
	(32	to	1382 $^\circ\text{F}$ )
Type K	-200	to	1250 $^\circ\text{C}$
	(-328	to	2282 $^\circ\text{F}$ )
Type N	0	to	1250 $^\circ\text{C}$
	(32	to	2282 $^\circ\text{F}$ )
Type S	0	to	1450 $^\circ\text{C}$
	(32	to	2642 $^\circ\text{F}$ )
Type T	-200	to	350 $^\circ\text{C}$
	(-328	to	662 $^\circ\text{F}$ )

### • RTD Resolution (DIN or JIS)

1 $^\circ$	-200	to	700 $^\circ\text{C}$
	(-328	to	1292 $^\circ\text{F}$ )
0.1 $^\circ$	-128.8	to	537.7 $^\circ\text{C}$
	(-199.9	to	999.9 $^\circ\text{F}$ )

### • Process

- 4-20mA @  $5\Omega$ , or -999 to 9999 units
- 0-5V (dc) @  $10\text{k}\Omega$ , or -999 to 9999 units

## Output 1 (Heating or Cooling)

- Electromechanical relay<sup>1</sup>, Form C, 5A @ 120/240V $\sim$  (ac) maximum, without contact suppression, rated resistive load, 5A @ 30V $\approx$  (dc)<sup>2</sup>. Minimum contact current, 100mA @ 5V $\approx$  (dc).
- Switched dc signal provides a non-isolated minimum turn on voltage of 3V $\approx$  (dc) into a minimum  $500\Omega$  load; maximum on voltage not greater than 12V $\approx$  (dc) into an infinite load.
- 4-20mA reverse or direct acting, non-isolated 0 to  $800\Omega$  load.
- Solid-state relay<sup>2</sup>, Form A, 0.5A @ 24V $\sim$  (ac) min., 264V $\sim$  (ac) max., opto-isolated burst fire switched, without contact suppression. Off-state output impedance is  $31\text{M}\Omega$ .

## Output 2 (Heat, Cool or Alarm)

- Electromechanical relay<sup>1</sup>, Form C, 5A @ 120/240V $\sim$  (ac) maximum, without contact suppression, rated resistive load, 5A @ 30V $\approx$  (dc)<sup>2</sup>. Minimum contact current, 100mA @ 5V $\approx$  (dc).
- Switched dc signal provides a non-isolated minimum turn on voltage of 3V $\approx$  (dc) into a minimum  $500\Omega$  load; maximum on voltage not greater than 12V $\approx$  (dc) into an infinite load.

- Solid-state relay<sup>2</sup>, Form A, 0.5A @ 24V $\sim$  (ac) min., 264V $\sim$  (ac) max., opto-isolated burst fire switched, without contact suppression. Off-state output impedance is  $31\text{M}\Omega$ .
- Alarm output can be latching or non-latching, and process or deviation with separate high and low values. Alarm silencing (inhibit) on power up (for deviation alarms only).

## Output Configurations

### • Output 1

- User-selectable as: on-off: P, PI, PD, PID, heat or cool action
- Adjustable switching differential: 1 to  $55^\circ\text{C}$  (1 to  $99^\circ\text{F}$ )
- Proportional band: 0 (off) or 0 to  $555^\circ\text{C}$  (1 to  $999^\circ\text{F}$ ) or 0.0 to 999.9 units
- Integral: 0 (off) or 0.1 to 99.9 minutes per repeat
- Reset: 0 (off) or 0.01 to 9.99 repeats per minute
- Rate/derivative: 0 (off) or 0.01 to 9.99 minutes
- Cycle time: 0.1 to 999.9 seconds

### • Output 2

- User selectable as: Control with action opposite that of Output 1 (heating or cooling)
- Process or deviation alarm with flashing alarm message
- Process or deviation alarm without alarm message
- Alarm with separate high and low set points
- Hysteresis: 1 to  $9999^\circ$  or units switching differential

## Line Voltage/Power

- 100-240V $\sim$  (ac), -15%, +10%<sup>4</sup>; (85-264V $\sim$  [ac]) 50/60Hz,  $\pm 5\%$
- 12-24V $\approx$  (ac/dc), +10%, -15%; (10-26V $\approx$  [ac/dc]) 50/60Hz,  $\pm 5\%$
- Fused internally (factory replaceable only) Slo-Blo<sup>®</sup> type (time-lag):  
1A, 250V for high voltage versions  
2A, 250V for low voltage versions
- Maximum power consumption: 12VA (100 to 240V $\sim$ ), 7VA (12 to 24V $\approx$ )
- Data retention upon power failure via non-volatile memory

## Operating Environment<sup>3</sup>

- 0 to  $65^\circ\text{C}$  (32 to  $149^\circ\text{F}$ ).
- 0 to 90% RH, non-condensing

## Storage Temperature

- $-40^\circ$  to  $85^\circ\text{C}$  ( $-40^\circ$  to  $185^\circ\text{F}$ )

## Terminals

- #6 compression universal head screw terminals, accepts 20-14 gauge wire. Torque to 1.4 Nm (12 in-lb).

## Controller Weight

- 0.2 kg (0.4 lb)

## Shipping Weight

- 0.34 kg (0.75 lb)

## Dimensions

- Compact 1/16 DIN size and IP65<sup>4</sup> (NEMA 4X), front panel make the Series 93 easy to apply and maintain in a wide variety of applications. The unique mounting bezel, gasket and collar make installation a snap.

Overall Height:	55 mm	(2.1 inches)
Width:	55 mm	(2.1 inches)
Depth:	120 mm	(4.7 inches)
Bezel Height:	55 mm	(2.1 inches)
Width:	55 mm	(2.1 inches)
Depth:	15 mm	(0.6 inches)
Chassis Height:	45 mm	(1.8 inches)
Width:	45 mm	(1.8 inches)
Depth:	105 mm	(4.1 inches)

## Agency Approvals

- UL508 listed, c-UL, CE, IP65 (NEMA 4X), File #E102269
- CE:  
89/336/EEC (EN 61326)  
73/23/EEC (EN61010-1)

- 1 Electromechanical relays warranted for 100,000 closures only. Solid-state switching devices recommended for applications requiring fast cycle times or extended service life.
- 2 Switching inductive loads (relay coils, etc.) requires using an RC suppressor.
- 3 Operating environment is 0 to  $60^\circ\text{C}$  for line voltage exceeding 240V.
- 4 To effect IP65 (NEMA 4X) rating requires a minimum mounting panel thickness of 1.5 mm (0.06 inch) and surface finish not rougher than  $812\mu\text{m}$  ( $0.32\mu\text{m}$  inch). Use Greenlee punch 60287.

# Series 93 Model Number Information

## Ordering Information

(2219)

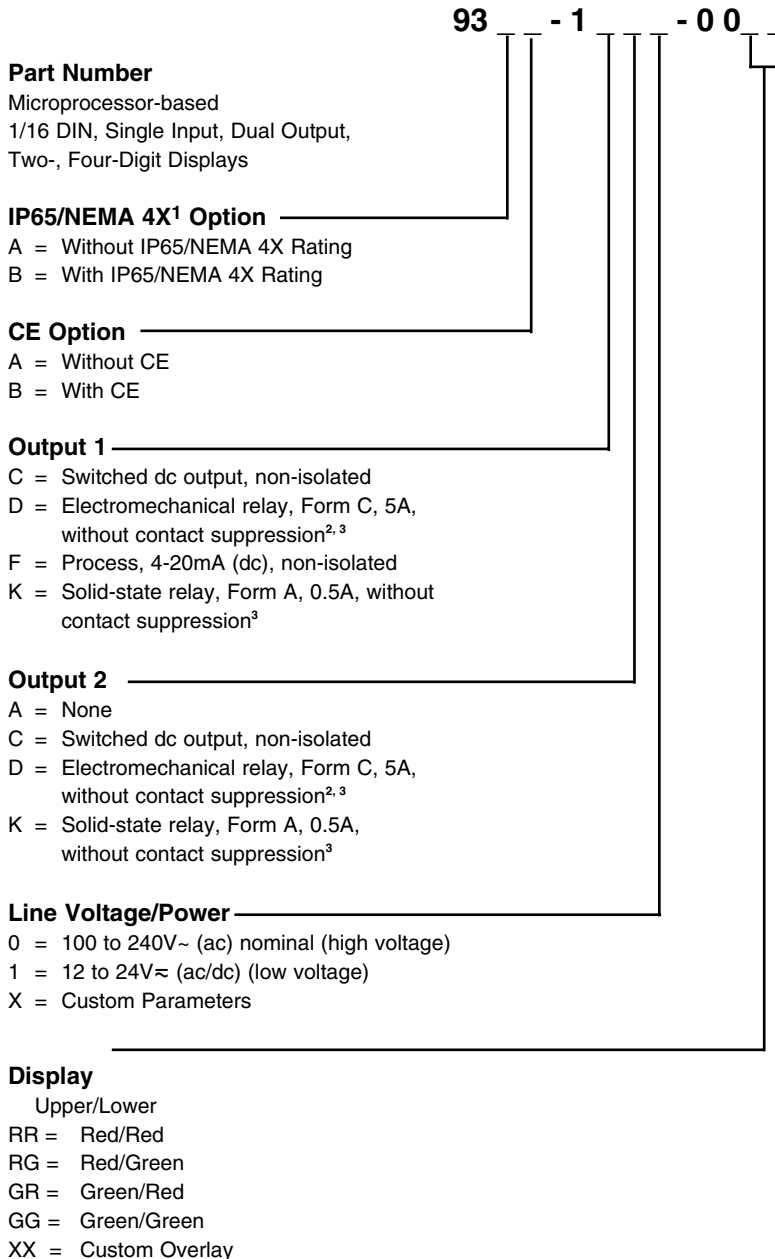

<sup>1</sup>To effect IP65/NEMA 4X rating requires a minimum mounting panel thickness of 1.5 mm (0.06 inch) and surface finish not rougher than 812  $\mu$ m (0.32  $\mu$  inch). Use Greenlee punch #60287.

<sup>2</sup>Electromechanical relays warranted for 100,000 closures only. Solid-state switching devices recommended for applications requiring fast cycle times or extended service life.

<sup>3</sup>Switching inductive loads (relay coils, etc.) requires using an RC suppressor. Quencharc from ITW PAKTRON is recommended, Watlow part number 0804-0147-0000.

# Index

## A

- ⊕ Advance key 3.1
- Alarm High 4.7
- Alarm Low 4.7
- alarm silencing 5.5
- alarms 5.4
- automatic operation 5.3
- autotuning 5.1
- Autotune 4.7

## B - C

- calibration A.3
- Calibration Menu A.4
- Calibration Offset 4.7
- Celsius-Fahrenheit 4.3
- clearing an alarm 5.4
- Cycle Time 4.6

## D

- default parameters
  - Operation 4.6-4.7
  - Setup 4.3-4.5
- Derivative 4.6
- Deviation alarm 5.4
- dimensions
  - faceplate 2.1
  - panel cutout 2.1
  - side view 2.1
- DIP Switches 4.1
- Display 3.1, 4.5
- ▼ Down-arrow key 3.1

## E

- entering the Setup Menu 4.2
- error codes 5.5-5.6

## F

- field calibration A.5-A.7

## G

- general description 1.1
- Glossary A.9

## H

- high voltage wiring 2.3
- Hysteresis 4.4

## I

- indicator lights 3.1
- ⊕ Infinity key 3.1
- Input
  - wiring 2.4
  - DIP Switch 4.1
  - ranges 4.5
  - RTD 4.4
  - thermocouple 2.4
  - type 4.3
- Integral 4.6

## J - K

- Keys 3.1

## L

- ladder wiring diagram 2.9
- Latching 4.4, 5.4
- Lock Parameter 4.3
- low voltage wiring 2.3
- Lower Display 3.1

## M

- manual operation 5.3
- manual tuning 5.2
- mechanical relay, 5 Amp
  - Output 1 Wiring 2.6
  - Output 2 Wiring 2.8
- Model Number A.13
- mounting collar 2.2
- mounting case 2.2

## N

- Noise
  - eliminating A.2
  - sources A.1
  - decreasing sensitivity A.1

## O

- Operation Menu 4.6-4.7
- Operation Parameters 4.6
- Output 1 4.4
- Output 2 4.4
- Output Wiring
  - 5A Mechanical Relay 2.6, 2.8
  - 4-20mA 2.7
  - switched dc 2.7, 2.8
  - solid-state relay 2.6, 2.8
- overview of the Series 93 1.1

## P

- %Percent Power Indicator Light 3.1
- Power Limiting 4.5
- power wiring 2.3
- process alarm 5.4
- process input 2.5
- Proportional Band 4.6

## Q

- Quick Reference Sheet A.17-A.18

## R

- Ramping 4.4
- Range High 4.4
- Range Low 4.3
- Rate 4.6
- removing controller 2.2
- Reset 4.6
- restoring calibration A.4

- returns back cover
- RTD Calibration A.5
- RTD Sensor Wiring 2.4

## S

- sensor installation 2.4
- Setting a Set Point 5.3
- Setup Menu 4.1, 4.2
- Setup Parameters 4.3
- Silencing 4.4
- Specifications A.12

## T

- thermocouple calibration A.5
- thermocouple sensor wiring 2.4
- terminals A.12
- torque A.12
- tuning 5.1-5.3

## U - Z

- ⬆ Up-arrow key 3.1
- Upper Display 3.1
- warranty back cover
- wiring 2.3
- wiring example 2.9

# Declaration of Conformity

## Series 93

WATLOW Winona, Inc.

1241 Bundy Boulevard

Winona, Minnesota 55987 USA



Declares that the following product:

English

Designation: Series 93  
Model Number(s): 93 (A or B) B – 1 ( C, D, F or K) ( A , C, D, or K) (0 or 1) – (Any four letters or numbers)  
Classification: Temperature control, Installation Category II, Pollution degree 2  
Rated Voltage: 100 to 240 V~ (ac) or 12 to 24 V≈ (ac or dc)  
Rated Frequency: 50 or 60 Hz  
Rated Power Consumption: 12VA maximum (100 to 240 V~ units), 7 VA (12 to 24 V≈ units)

Meets the essential requirements of the following European Union Directives by using the relevant standards show below to indicate compliance.

### 89/336/EEC Electromagnetic Compatibility Directive

EN 61326:1997 With A1:1998 – Electrical equipment for measurement, control and laboratory use – EMC requirements (Industrial Immunity, Class A Emissions).

EN 61000-4-2:1996 With A1, 1998 – Electrostatic Discharge Immunity  
EN 61000-4-3:1997 – Radiated Field Immunity  
EN 61000-4-4:1995 – Electrical Fast-Transient / Burst Immunity  
EN 61000-4-5:1995 With A1, 1996 – Surge Immunity  
EN 61000-4-6:1996 – Conducted Immunity  
EN 61000-4-11:1994 Voltage Dips, Short Interruptions and Voltage Variations Immunity  
EN 61000-3-2:1995 With A1-3:1999 – Harmonic Current Emissions  
EN 61000-3-3:1995 With A1:1998 – Voltage Fluctuations and Flicker

### 73/23/EEC Low-Voltage Directive

EN 61010-1:1993 With A1:1995 Safety Requirements of electrical equipment for measurement, control and laboratory use. Part 1: General requirements

déclare que le produit suivant :

Français

Désignation : Series 93  
Numéros de modèles : 93 (A or B) B – 1 ( C, D, F or K) ( A , C, D, or K) (0 ou 1) (N'importe quelle combinaison de quatre lettres ou chiffres)  
Classification : Régulation de température, Catégorie d'installation II, Degré de pollution 2  
Tension nominale : 100 à 240 V~ (c.a) ou 12 à 24 V ≈ (c.a ou c.c)  
Fréquence nominale : 50 ou 60 Hz  
Consommation d'alimentation nominale : 12 VA maximum (100 à 240 V~ unités), 7 VA (12 à 24 V ≈ unités)

Répond aux normes essentielles des directives suivantes de l'Union européenne en utilisant les standards normalisés ci-dessous qui expliquent les normes auxquelles répondre :

### Directive 89/336/CEE sur la compatibilité électromagnétique

EN 61326:1997 avec A1 :1998 – Matériel électrique destiné à l'étalonnage, au contrôle et à l'utilisation en laboratoire – Exigences CEM (Immunité industrielle, Émissions de catégorie A).

EN 61000-4-2:1996 Avec A1, 1998 – Immunité aux décharges électrostatiques  
EN 61000-4-3:1997 – Immunité aux champs de radiation  
EN 61000-4-4:1995 – Immunité contre les surtensions électriques rapides/ Rafale  
EN 61000-4-5:1995 avec A1, 1996 – Immunité contre les surtensions  
EN 61000-4-6:1996 – Immunité conduite  
EN 61000-4-11:1994 Immunité contre les écarts de tension, interruptions courtes et variations de tension  
EN 61000-3-2:1995 avec A1-3 :1999 – Emissions de courant harmoniques  
EN 61000-3-3:1995 avec A1 :1998 – Fluctuations et vacillements de tension

### Directive 73/23/CEE sur les basses tensions

EN 61010-1:1993 avec A1 :1995 Normes de sécurité du matériel électrique pour la mesure, le contrôle et l'utilisation en laboratoire. 1ère partie : Conditions générales

(2406)

Watlow Series 93

Erklärt, dass das folgende Produkt:

Deutsch

Bezeichnung: Series 93  
Modell-Nummern: 93 (A oder B) B – 1 ( C, D, F oder K) ( A , C, D, oder K) (0 oder 1) - (Beliebige vier Ziffern oder Buchstaben)  
Klassifikation: Temperaturregler, Installationskategorie II, Verschmutzungsgrad 2  
Nennspannung: 100 bis 240 V~ (ac) oder 12 bis 24 V ≈ (AC oder DC)  
Nennfrequenz: 50 oder 60 Hz  
Nennstromverbrauch: 12 VA max. (100 bis 240 V~ -Systeme), 7 VA (12 bis 24 V ≈ -Systeme)

Erfüllt die wichtigsten Normen der folgenden Anweisung(en) der Europäischen Union unter Verwendung des wichtigsten Abschnitts bzw. der wichtigsten Abschnitte die unten zur Befolgung aufgezeigt werden.

### 89/336/EEC Elektromagnetische Kompatibilitätsrichtlinie

EN 61326:1997 mit A1:1998 – Elektrisches Gerät für Messung, Kontrolle und Laborgebrauch – EMV-Anforderungen (Störfestigkeit Industriebereich, Klasse A Emissionen)

EN 61000-4-2:1996 mit A1, 1998 – Störfestigkeit gegen elektronische Entladung  
EN 61000-4-3:1997 – Störfestigkeit gegen Strahlungsfelder  
EN 61000-4-4:1995 – Störfestigkeit gegen schnelle Stöße/Burst  
EN 61000-4-5:1995 mit A1, 1996 – Störfestigkeit gegen Überspannung  
EN 61000-4-6:1996 – Geleitete Störfestigkeit  
EN 61000-4-11:1994 Störfestigkeit gegen Spannungsabfall, kurze Unterbrechungen und Spannungsschwankungen  
EN 61000-3-2:1995 mit A1-3:1999 – Harmonische Stromemissionen  
EN 61000-3-3:1995 mit A1:1998 – Spannungsfuktationen und Flimmern  
EN 61000-3-3: 1995 Grenzen der Spannungsschwankungen und Flimmern

### 73/23/EEC Niederspannungsrichtlinie

EN 61010-1:1993 mit A1:1995 Sicherheitsanforderungen für elektrische Geräte für Messungen, Kontrolle und Laborgebrauch. Teil 1: Allgemeine Anforderungen

Declara que el producto siguiente:

Español

Designación: Series 93  
Números de modelo: 93 (A o B) B – 1 ( C, D, F o K) ( A , C, D, o K) (0 o 1) - (Cualesquiera cuatro letras o números)  
Clasificación: Control de temperatura, Categoría de instalación II, Grado de contaminación 2  
Tensión nominal: 100 a 240 V~ (CA) o 12 a 24 V ≈ (CA o CD)  
Frecuencia nominal: 50 o 60 Hz  
Consumo nominal de energía: 12 VA máximo (unidades de 100 a 240 V~), 7 VA (unidades de 12 a 24 V ≈)

Cumple con los requisitos esenciales de las siguientes Directrices de la Unión Europea mediante el uso de las normas aplicables que se muestran a continuación para indicar su conformidad.

### 89/336/EEC Directriz de compatibilidad electromagnética

EN 61326:1997 CON A1:1998.– Equipo eléctrico para medición, control y uso en laboratorio – Requisitos EMC (Inmunidad industrial, Emisiones Clase A).

EN 61000-4-2:1996 con A1, 1998 – Inmunidad a descarga electrostática  
EN 61000-4-3:1997 – Inmunidad a campo radiado  
EN 61000-4-4:1995 – Inmunidad a incremento repentino/rápidas fluctuaciones eléctricas transitorias  
EN 61000-4-5:1995 con A1, 1996 – Inmunidad a picos de voltaje o corriente  
EN 61000-4-6:1996 – Inmunidad por conducción  
EN 61000-4-11:1994 Inmunidad a caídas de voltaje, variaciones y pequeñas interrupciones de voltaje  
EN 61000-3-2:1995 con A1-3:1999 – Emisiones de corriente armónica  
EN 61000-3-3:1995 con A1:1998 – Fluctuaciones de voltaje y centelleo.

### 73/23/EEC Directriz de bajo voltaje

EN 61010-1:1993 con A1:1995 Requisitos de seguridad de equipo eléctrico para medición, control y uso en laboratorio. Parte 1: Requisitos generales

Raymond D. Feller III  
Name of Authorized Representative

Winona, Minnesota, USA  
Place of Issue

General Manager  
Title of Authorized Representative

October 2003  
Date of Issue

Signature of Authorized Representative

# Notes



# Series 93 Quick Reference

## Keys and Displays

**Upper Display:** Indicates the process value, actual temperature, operating parameter values or an open sensor. When powering up, the Process display will be blank for five seconds.

- To set to blank: set  $\boxed{dSP}$  to  $\boxed{SE}$  in the Setup Menu.

**Lower Display:** Indicates the set point, output value, parameters for data in the upper display, or error and alarm codes.

- To set to blank: set  $\boxed{dSP}$  to  $\boxed{Pr}$  in the Setup Menu.

**Advance Key:** Press to step through the Operations, Setup and Calibration Menus. In the Auto mode, new data is self-entering in five seconds.

**Up-arrow and Down-arrow Keys:** Increases or decreases the value of the displayed parameter.

- Press lightly to increase or decrease the value by one.
- Press and hold down to increase or decrease the displayed value at a rapid rate. New data will self-enter in five seconds, or can be entered by pressing the Advance Key.
- Press both keys simultaneously for three seconds to enter the Setup Menu. The  $\boxed{LOC}$  parameter appears.
- Continue pressing both keys to enter the Calibration Menu.

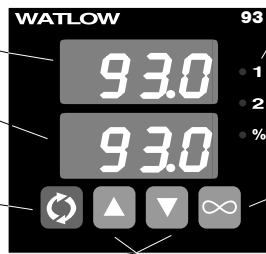

**Output 1 Indicator Light:** Lit when Output 1 is energized.

**Output 2 Indicator Light:** Lit when Output 2 is active. This output can be configured as a control or alarm output.

**% Percent Power Indicator Light**

- Lit: the controller is in Manual operation. Press the  $\infty$  Infinity key twice to enter Automatic operation.
- Blinking: press the  $\infty$  Infinity key to toggle between Auto and Manual. Returns to its previous state and stops blinking if the  $\infty$  Infinity key is not pressed within five seconds.

**Infinity Key**

- Press once to clear any latched alarms. Also disables alarm output if silencing is enabled.
- Press again within five seconds to change from Auto to Manual or vice versa. While in Manual mode, percent power is in the lower display.

## Alarms

A **process alarm** sets an absolute temperature. When the process exceeds that absolute temperature limit, an alarm occurs. The process alarm set points may be independently set high and low. Under the Setup Menu, select the type of alarm output with the  $\boxed{OE2}$  parameter.  $\boxed{PrA}$  sets a process alarm with alarm message displayed.  $\boxed{Pr}$  sets a process alarm with no alarm message displayed.

A **deviation alarm** alerts the operator when the process strays too far from the set point. The operator can enter independent high and low alarm settings. The reference for the deviation alarm is the set point. Any change in set point causes a corresponding shift in the deviation alarm.  $\boxed{dEA}$  sets a deviation alarm with alarm message displayed.  $\boxed{dE}$  sets a deviation alarm with no alarm message displayed.

**Example:** If your set point is 100°F, and a deviation alarm is set to +7°F as the high limit, and -5°F as the low limit, the high alarm trips at 107°F, and the low alarm at 95°F. If you change the set point to 130°F, the alarms follow the set point and trip at 137°F and 125°F.

### To clear an alarm:

- First correct the alarm condition, then...
- If the alarm is latching:**  
Clear it manually; press the  $\infty$  Infinity key once as soon as the process temperature is inside the  $\boxed{HSA}$  parameter alarm limit.
- If the alarm is non-latching:**  
The alarm clears itself automatically as soon as the process temperature is inside the  $\boxed{HSA}$  parameter.

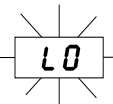
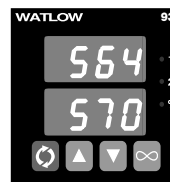

Press once to clear a latched and corrected alarm.

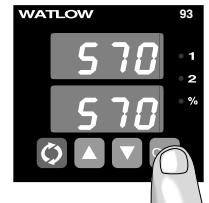

Flashing  $\boxed{LO}$  or  $\boxed{HI}$  in the lower display indicates an alarm when  $\boxed{OE2}$  is set to  $\boxed{PrA}$  or  $\boxed{dEA}$ . The lower display alternately shows information from the current parameter and the  $\boxed{LO}$  or  $\boxed{HI}$  alarm message at one-second intervals. The alarm output is de-energized and the Output 2 indicator light is lit.

**Alarm Silencing** is available with the deviation alarm and has two uses:

When  $\boxed{SIL}$  is set to "on," the operator must manually disable the alarm by pressing the  $\infty$  Infinity key once on initial power up (in either the latching or non-latching mode). Alarm silencing disables the alarm output relay. However, the Output 2 indicator light (also the lower display when  $\boxed{OE2}$  is set to  $\boxed{dEA}$ ) shows an alarm condition until the process value is within the "safe" region of the deviation alarm band. Once the process value crosses into the "safe" region, both a latching or a non-latching alarm is ready. Any future deviation outside this safe band triggers an alarm.

**Latching:** Both process and deviation alarms can be latching or non-latching. When the alarm condition is removed a **non-latching alarm automatically** clears the alarm output. You must **manually clear a latching alarm** before it will disappear.

## Errors

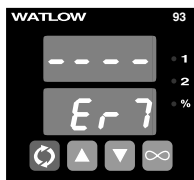

Four dashes  $\boxed{----}$  in the upper display indicate a Series 93 error. The error code is visible in the lower display.

### $\boxed{Er2}$ - Sensor underrange error (applies only to RTD units)

The sensor input generated a value lower than the allowable signal range, or the analog-to-digital circuitry malfunctioned. Enter

a valid input. Make sure the  $\boxed{In}$  parameter (Setup Menu) and the DIP switch settings both match your sensor.

### $\boxed{Er4}$ - Configuration error

The controller's microprocessor is faulty; call the factory.

### $\boxed{Er5}$ - Nonvolatile checksum error

The nonvolatile memory checksum discovered a checksum error. Unless a momentary power interruption occurred while the controller was storing data, the nonvolatile memory is faulty. Call the factory.

### $\boxed{Er6}$ - Analog-to-digital underflow error

The analog-to-digital circuit is underrange. An open or reversed polarity sensor is the most likely cause. Check the sensor; if the connection is good and functions properly, call the factory. The analog-to-digital underrange voltage is too low to convert an analog-to-digital signal. Make sure the  $\boxed{In}$  parameter matches your sensor and the DIP switches are set accordingly.

### $\boxed{Er7}$ - Analog-to-digital overflow error

The analog-to-digital circuit is overrange. An open or reversed polarity sensor is the most likely cause. Check the sensor; if the connection is good, and the sensor functions properly, call the factory. The analog-to-digital overrange voltage is too high to convert an analog-to-digital signal. Make sure the  $\boxed{In}$  parameter (Setup Menu) matches your sensor and the DIP switches are set accordingly.

# Setup Menu



Enter the Setup Menu by pressing the **Up**-arrow and **Down**-arrow keys simultaneously for three seconds. The lower display shows the **LDC** Lock parameter, and the upper display shows its current level. All keys are inactive until you release both keys. You can reach the Lock parameter from anywhere. Use the **Advance** key to move through the menus and the **Up**-arrow and **Down**-arrow keys to select data. You will not see all parameters in this menu, depending on the controller's configuration and model number.

### Setup Menu

- LDC** Lock
- In** Input
- dEC** Decimal\*
- C-F** Celsius - Fahrenheit\*
- rL** Range Low
- rH** Range High
- DE1** Output 1
- HSC** Hysteresis Control
- DE2** Output 2
- HSA** Hysteresis Alarm\*
- LRE** Latching\*
- SIL** Silencing\*
- RTD** RTD\*
- rP** Ramping
- rE** Rate\*
- PL** Power Limiting\*
- dSP** Display

\* Parameter may not always appear.

**Note:**  
Do not enter any values here;  
make photocopies instead.

### Operation Menu

- 93** Control Set Point
- Pb1** Proportional Band 1
- rE1** Reset 1\*
- IE1** Integral 1\*
- RA1** Rate 1\*
- dE1** Derivative 1\*
- CE1** Cycle Time 1\*
- ALD** Alarm Low\*
- AH1** Alarm High\*
- Pb2** Proportional Band 2\*
- rE2** Reset 2\*
- IE2** Integral 2\*
- RA2** Rate 2\*
- dE2** Derivative 2\*
- CE2** Cycle Time 2\*
- CAL** Calibration Offset
- AUT** Autotune

\* Parameter may not always appear.

Parameter	Value	Range	Factory Default	Appears If:
<b>LDC</b>		0 - 4	0	
<b>In</b>		<b>d</b> , <b>H</b> , <b>E</b> , <b>n</b> <b>S</b> , <b>rt.d</b> , <b>ct.d</b> , <b>D-S</b> , <b>420</b>	<b>d</b>	DIP switch-selectable.
<b>dEC</b>		0, 0.0, 0.00	0	<b>In</b> is set to <b>D-S</b> or <b>420</b>
<b>C-F</b>		<b>C</b> or <b>F</b>	Dependent on <b>dFL</b>	<b>In</b> is set to <b>d</b> , <b>H</b> , <b>E</b> , <b>n</b> , <b>S</b> , <b>rt.d</b> , or <b>ct.d</b>
<b>rL</b>		<b>rL</b> to <b>rH</b>	Input dependent.	
<b>rH</b>		<b>rH</b> to <b>rL</b>	Input dependent.	
<b>DE1</b>		<b>hE</b> or <b>CL</b>	<b>hE</b>	
<b>HSC</b>		1 to 55, 0.1 to 5.5, 0.01 to 0.55°C 1 to 99, 0.1 to 9.9, 0.01 to 0.99°F	2, 0.2, 0.02°C 3, 0.3, 0.03°F	
<b>DE2</b>		<b>Con</b> Control <b>PrA</b> Process Alarm <b>Pr</b> Process with no alarm message <b>dEA</b> Deviation alarm <b>dE</b> Deviation with no alarm message <b>no</b> None	<b>Con</b>	
<b>HSA</b>		1 to 5555, 0.1 to 555.5, 0.01 to 55.55°C 1 to 9999, 0.1 to 999.9, 0.01 to 99.99°F	2, 0.2, 0.02°C 3, 0.3, 0.03°F	<b>DE2</b> is not set to <b>Con</b> or <b>no</b>
<b>LRE</b>		<b>LRE</b> or <b>nLR</b>	<b>nLR</b>	<b>DE2</b> is not set to <b>Con</b> or <b>no</b>
<b>SIL</b>		<b>On</b> or <b>OFF</b>	<b>OFF</b>	<b>DE2</b> is set to <b>dEA</b> or <b>dE</b>
<b>RTD</b>		<b>d15</b> or <b>d.in</b>	<b>d.in</b>	<b>In</b> is set to <b>rt.d</b> or <b>ct.d</b>
<b>rP</b>		<b>SEr</b> is set to Ramping on power up <b>on</b> is set to Ramping to set point always <b>OFF</b> is set to None	<b>OFF</b>	
<b>rE</b>		0 to 9999	100°/hr	<b>rP</b> is not set to <b>OFF</b>
<b>PL</b>		0 to 100	100	
<b>dSP</b>		<b>nor</b> normal <b>SEt</b> Set Point (lower only) <b>Pro</b> Process (upper only)	<b>nor</b>	

# Operation Menu

Parameter	Value	Range	Factory Default
<b>Pb1</b>		If <b>dFL</b> is set to <b>US</b> : 0 to 555°C/0 to 999°F/0 to 999 Units 0 to 55.5°C/0 to 99.9°F/0 to 99.9 Units 0 is set to on-off control. <b>HSC</b> is set to switch differential If <b>dFL</b> is set to <b>S1</b> : 0.0 to 999.9% of span	25°F 2.5°F
<b>rE1</b>		0.00 to 9.99 repeats/minute 0.00 = No Reset. Won't appear if <b>Pb1</b> is set to 0 or <b>dFL</b> is set to <b>S1</b> .	0.00 repeats/minute
<b>IE1</b>		0.0 to 99.9 minutes/rpt. 0.00 = No Integral. Won't appear if <b>Pb1</b> is set to 0 or <b>dFL</b> is set to <b>US</b> .	00.0 minutes/repeat
<b>RA1</b>		0.00 to 9.99 minutes 0.00 = No Rate. Will not appear if <b>Pb1</b> is set to 0 or <b>dFL</b> is set to <b>S1</b> .	0.00 minutes
<b>dE1</b>		0.00 to 9.99 minutes. 0.00 = No Derivative. Won't appear if <b>Pb1</b> is set to 0 or <b>dFL</b> is set to <b>US</b> .	0.00 minutes
<b>CE1</b>		0.1 to 999.9 Won't appear if <b>Pb1</b> = 0, or <b>420</b> .	5.0 seconds
<b>Pb2</b>		Same as <b>Pb1</b> . <b>Pb2</b> lower limit = 1, 0.1, 0.01	
<b>rE2</b>		Same range as <b>rE1</b> .	
<b>IE2</b>		Same range as <b>IE1</b> .	
<b>RA2</b>		Same range as <b>RA1</b> .	
<b>dE2</b>		Same range as <b>dE1</b> .	
<b>CE2</b>		Same range as <b>CE1</b> .	
<b>ALD</b>		Deviation <b>dE</b> Process <b>Pr</b>	-999 to 0 <b>rL</b> to <b>AH1</b> Will not appear if <b>DE2</b> is set to <b>no</b> or <b>Con</b> .
<b>AH1</b>		Deviation <b>dE</b> Process <b>Pr</b>	0 to 999 <b>ALD</b> to <b>rH</b> Will not appear if <b>DE2</b> is set to <b>no</b> or <b>Con</b> .
<b>CAL</b>		±100°C/±180°F/±180 Units	0
<b>AUT</b>		0 to 3	0



# Watlow Winona

Watlow Winona is a division of Watlow Electric Mfg. Co., St. Louis, Missouri, a manufacturer of industrial electric heating products, since 1922. Watlow begins with a full set of specifications and completes an industrial product that is manufactured totally in-house, in the U.S.A. Watlow products include electric heaters, sensors, controls and switching devices. The Winona operation has been designing solid-state electronic control devices since 1962, and has earned the reputation as an excellent supplier to original equipment manufacturers. These OEMs depend upon Watlow Winona to provide compatibly engineered controls that they can incorporate into their products with confidence. Watlow Winona resides in a 100,000-square-foot marketing, engineering and manufacturing facility in Winona, Minnesota.

---

# How to Reach Us



## Your Authorized Watlow Distributor:

### Corporate Headquarters in the U.S.:

Watlow Electric Manufacturing Co.  
12001 Lackland Road  
St. Louis, Missouri, USA 63146  
Telephone: +1 (314) 878-4600  
Fax: +1 (314) 878-6814

### Europe:

Watlow GmbH  
Industriegebiet Heidig  
Lauchwasenstr. 1, Postfach 1165  
Kronau 76709 Germany  
Telephone: +49 -7253-9400-0  
Fax: +49 -7253-9400-44

Watlow France S.A.R.L.  
Immeuble Somag, 16 Rue Ampère,  
Cergy Pontoise CEDEX 95307 France  
Telephone: +33 (1) 3073-2425  
Fax: +33 (1) 3073-2875

Watlow Italy S.r.l.  
Via Meucci 14,  
20094 Corsico MI  
Italy  
Telephone: +39 (02) 4588841  
Fax: +39 (02) 458-69954

Watlow Limited  
Robey Close, Linby Industrial Estate,  
Linby Nottingham England, NG15 8AA  
Telephone: +44 (0) 115 9640777  
Fax: +44 (0) 115 9640071

### Latin America:

Watlow de México  
Av. Epigmenio Gonzalez #5,  
Col. Parques Industriales,  
Querétaro, Qro. México CP-76130  
Telephone: +52 442 217-6235  
Fax: +52 442 217-6403

### Asia/Pacific:

Watlow Australia Pty., Ltd.  
23 Gladstone Park Drive,  
Tullamarine, Victoria 3043 Australia  
Telephone: +61 (39) 335-6449  
Fax: +61 (39) 330-3566

Watlow China, Inc.  
Room 1903, Chang De Building  
No. 478-5 Chang Shou Road  
Shanghai 200060 China  
Telephone: +86 (21) 622772138  
+86 (21) 62273133  
Fax: +86 (21) 62278559

Watlow Japan Ltd. K.K.  
Azabu Embassy Heights 106,  
1-11-12 Akasaka,  
Minato-ku, Tokyo 107-0052 Japan  
Telephone: +81-3-5403-4688  
Fax: +81-3-5575-3373

Watlow Korea Co., Ltd.  
20-6 Yangjae-dong, Seocho-gu  
Seoul, Korea 137-130  
Telephone: +82 (2) 575-9804  
Fax: +82 (2) 575-9831

Watlow Malaysia Sdn Bhd  
38B Jalan Tun Dr Awang  
11900 Bayan Lepas  
Penang Malaysia  
Telephone: +60 (4) 641-5977  
Fax: +60 (4) 641-5979

Watlow Singapore Pte. Ltd.  
55 Ayer Rajah Crescent, #03-23  
Singapore 139949  
Telephone: +65 67739488  
Fax: +65 67780323

Watlow Electric Taiwan  
10F-1 No. 189  
Chi-Shen 2nd Road,  
Kaohsiung, Taiwan, 801  
Telephone: +886 (7) 288-5168  
Fax: +886 (7) 288-5568