

Series 733/734



**Total
Customer
Satisfaction**

3 Year
Warranty

Time/Temperature Control

Program Manual



WATLOW

Watlow Controls, 1241 Bundy Blvd., P.O. BOX 5580, Winona, MN 55987-5580, Phone: 507/454-5300, Fax: 507/452-4507

0600-0008-0002 Rev D
November 1995

Supersedes without changes: W733-XPMM-Rev D00

\$10.00

Made in the U.S.A.



Printed on Recycled Paper

Contents

Page	Item
	Chapter 1
3	Starting out with the Watlow Series 733/734
3	General Description
	Chapter 2
4	Keys & Displays
	Chapter 3
5	The Program Mode
5	Entering the Program Mode
6	Advancing to the Next Menu
6	Entering a Specific Menu
6	Select or Change Program Data in a Menu
6	Exiting the Program Mode
6	Clearing Alarm or Error Codes
7	Program Parameters
8	Program Master Step Chart
	Chapter 4
9	The Operation Mode
9	Operation Parameters
10	Running a Menu
10	Viewing Temperature While Running a Menu
10	Stopping a Menu
10	Entering the Review Mode
11	Entering the Monitor Mode
	Chapter 5
12	Using Alarms
13	Error Code Messages
14	Error Code Actions
	Appendix
15	Index
16	Notes
17	CE Declaration of Conformity
18	Specifications
19	Model Number

Notes



Informational notes alert you to important details. When you see a note icon, look for an explanation in the margin.

Safety Information

Boldface safety information protects both you and your equipment. Please be attentive to them. Here are explanations:



The CAUTION symbol (exclamation point) in the wide text column alerts you to a "CAUTION," a safety or functional hazard which could affect *your equipment* or its performance. A full explanation is in the narrow column on the outside of the page.



The WARNING symbol (lightning bolt) in the wide text column alerts you to a "**WARNING**," a safety hazard which could affect *you and the equipment*. A full explanation is in the narrow column on the outside of the page.

Technical Assistance



If you encounter a problem with your Series 733/734 control, review all of your configuration information to verify that your selections are consistent with your application... Inputs, Outputs, Alarms, Events, Limits, etc. If the problem persists after checking the above, you can get technical assistance by dialing 507/454-5300 and asking for an applications engineer.

An Application Engineer will discuss your problem with you. Please have the following information available:

- Complete model number
- All configuration information
- Revision number
- User's manual number

The model and serial numbers can be found on the label outside of the case.

Your Feedback

Your comments or suggestions on the manual are welcome, please send them to: Technical Writer, Watlow Controls, 1241 Bundy Blvd., P.O. Box 5580, Winona, MN 55987-5580, or phone 507/454-5300. The Watlow Series 733/734 User's Manual and integral software are copyrighted by Watlow Winona, Inc., © 1995, with all rights reserved.

Chapter 1

Starting Out With The Watlow Series 733/734, A Menu Driven Time/Temperature Control

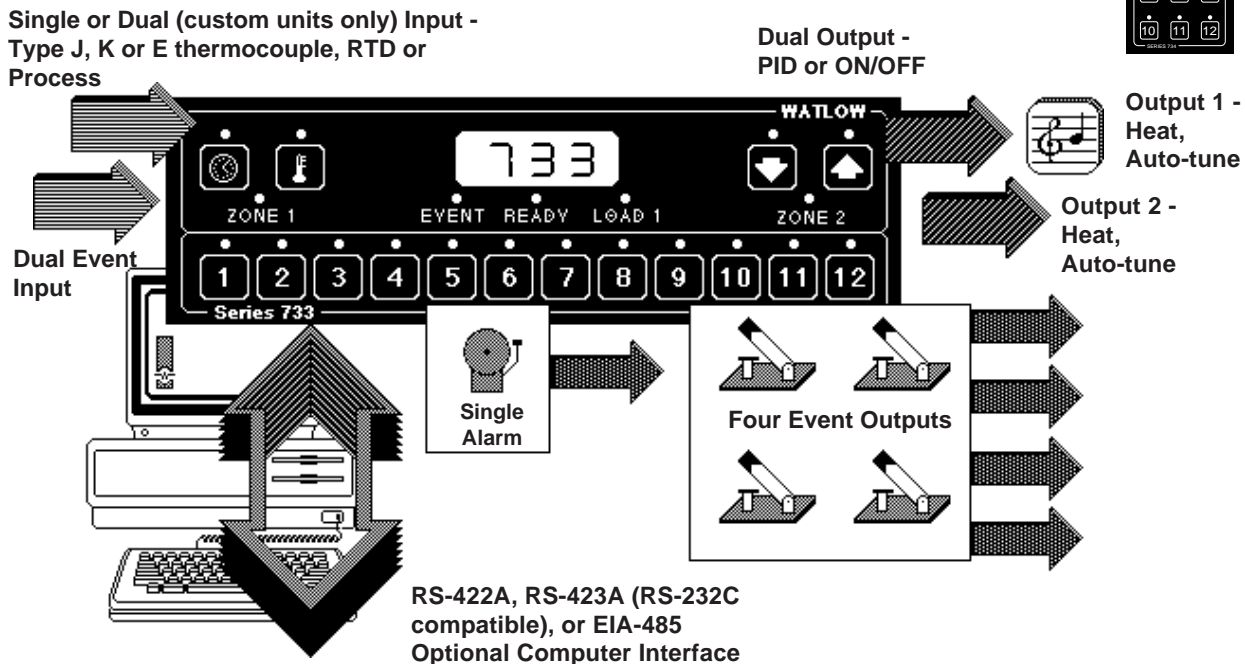

Figure 1 - Series 733/734 Input and Output Overview.

General Description

The Watlow Series 733/734 is a microprocessor-based, menu driven time/temperature control. Control orientation is available in horizontal or vertical versions with single or dual zones. The Series 733/734 has single or dual input and single or dual control outputs. Optional event input/output, alarms and communications are also available. The 733/734 offers a wide range of inputs and outputs. The 733/734 is a smart control which is easy to program and has operator friendly prompts. Auto-tune is also available with PID parameters. Standard features may include control melt cycle, WatCurve™ temperature compensation, calibration offset, a menu selection of time and temperature, and field changeable menus. In addition, Watlow offers customization services to meet special customer needs.

Watlow Controls provides an industry leading 3 year warranty on the Series 733/734. The Series 733/734 has electrical noise immunity which meets or exceeds major restaurant chain specifications. An additional feature is the high ambient rating of 176°F/80°C.

Operator-friendly features include automatic LED indicators to aid in monitoring and setup. The Watlow Series 733/734 automatically stores all information in a non-volatile memory.

Chapter 2 Keys & Displays

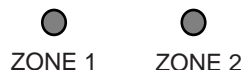

ZONE LED's

On a single zone control:

- Neither LED is displayed.

On a dual zone control:

- The LED is lit when the corresponding zone is active. The LED flashes when viewing or programming data in the Program mode.



Diagnostic LED's

Event

- Lit when an event is ON.

Ready

- Lit when the process temperature of each zone is within the guard band and no program is running.

Load 1

- Lit when Load 1 is energized.

Time

With the Time key you can:

- View time;
- Scroll 12 menus in the Program mode;
- Exit the Program mode;
- In the Review mode, it scrolls programmed menu parameters;
- Activates the Monitor mode;
- In the Monitor mode, it scrolls current data.

Temperature

With the Temperature key you can:

- View temperature;
- Activate the Review mode;
- Snooze alarm or error codes, and the auto-tune display for 30 seconds. For more information see Pages 19 - 23 of the *Series 733/734 Service Manual*;
- Energizes the alarm output if alarm silence is active.

Up and Down

With the Up/Down keys you can:

- Activate the Program mode;
- Scroll up and down through the parameter data.

Digital Display

Displays the countdown time, target menu temperature, menu parameters and security lockout codes. Consists of four red, seven segment LEDs.

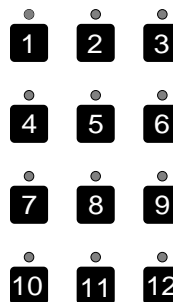

Menu Keys



With the Menu keys you can:

- Select a menu;
- Start and stop a menu;
- Silence the audible alarm;
- In the Program mode, you can scroll through the programmed data;
- Return to the Operation mode from the Monitor or Review mode.

Chapter 3 The Program Mode



Entering the Program Mode

The Program mode configures the Series 733/734 menus.

Press the UP/DOWN keys   simultaneously for 5 seconds. Both LED's above these keys are lit while in the Program mode. If there are no key activations within 1 minute, the control automatically exits the Program mode.

Press the appropriate menu key to program.

The display shows the SP1 (Step 1 set point) parameter **SP 1**, while the Menu LED is lit, and Zone LED (if applicable) is flashing.

The SP1 parameter alternately flashes with its current menu status. Use the UP/DOWN keys   to select the desired value for the parameter. Press the menu key to advance to the next parameter.

You can reach the Program mode only from the Operation mode. If you are running a menu, the unit quits running and beeps for 15 seconds, alerting you the program stopped. Not all parameters are visible in this menu, depending on the control configuration and model number.

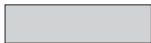
 = Parameter may not appear depending on control configuration and model number.

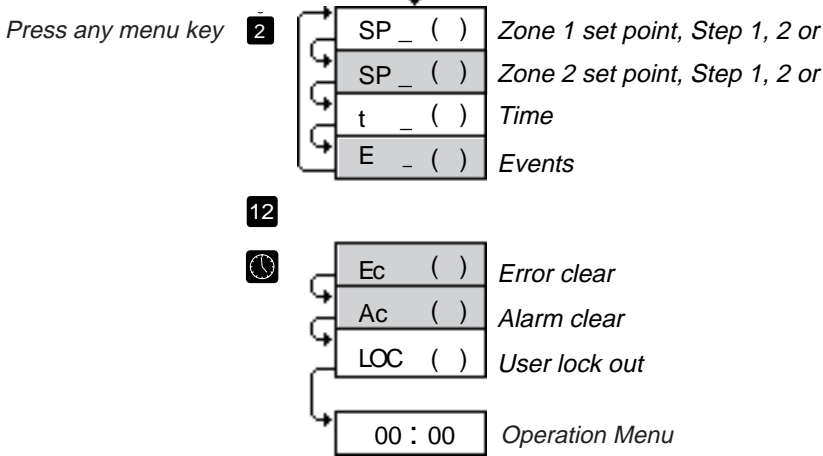





Figure 2 - The Program Mode

 **NOTE:**
A dash "_", represents a menu step number. This can be a 1, 2, or 3.

 **NOTE:**
On dual zone units, pay close attention to the LED's on the 733/734. The SP _ parameter is displayed twice, but refers to Zone 1 or Zone 2 depending on which LED is flashing.

Program

To Advance To The Next Menu

- Press the TIME (clock) key .
The unit scrolls to the next menu and the corresponding menu LED is lit.
After menu 12, the unit exits the Program mode.

OR

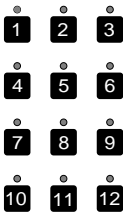





Entering A Specific Menu

Press the appropriate menu key and the program is displayed. Continue pressing the same menu key to advance to the next parameter in that menu. For more information, see the following for the parameter listings.



Select Or Change Program Data Within A Menu

Use the UP/DOWN keys  .

Exiting The Program Mode

- Press the last menu key (12) .
- Press the TIME key . The display goes to the LOC parameter.
Select either:
 - 0 All parameters can be changed.
 - 1 Menu parameters can only be viewed, **not** changed.
- Press the TIME key  again. You are back to the Operation mode .

Clearing Alarm or Error Codes

- Press the last menu key (12) .
- Press the Time key . The display goes to the Ec or Ac parameter.
- Press the Temperature key  to clear the error or alarm.
An error or alarm can only be cleared if the condition has been corrected.

Program

(S P _) Zone 1 Temperature Set Point: Press any menu key and the S P _ parameter is displayed and alternately flashes with the current set point for Zone 1. **On dual zone units, pay close attention to the LED's on the 733/734. The SP _ parameter is displayed twice, but refers to Zone 1 or Zone 2 depending on which LED is flashing.** The appropriate menu LED is also lit. **Range:** Range low to range high **Default:** 75°F/24°C

(S P _) Zone 2 Temperature Set Point: Press the same menu key and the S P _ parameter is displayed and alternately flashes with the current set point for Zone 2. **On dual zone units, pay close attention to the LED's on the 733/734. The SP _ parameter is displayed twice, but refers to Zone 1 or Zone 2 depending on which LED is flashing.** The appropriate menu LED is also lit. This parameter only appears if you have a dual zone unit.

Range: Range low to range high **Default:** 75°F/24°C/0 units

Time (t _): Press the same menu key and the t _ parameter is displayed and alternately flashes with the current program menu time. The appropriate menu LED is lit. Expressed in either hours/minutes, or minutes/seconds.

Range: 0 to 23:59 OR 0 to 59:59 **Default:** 0

Events (E _): Press the same menu key and the E _ parameter is displayed and alternately flashes with the event status.

This parameter determines the binary state of the Event Outputs. This parameter only appears if your unit has events. See the inside back cover for the model number breakdown. Each step in a menu can have up to 4 events. Press the UP or DOWN key to cycle through the binary options until you reach the appropriate combination. Events 1 through 4 are read from right to left. 1 = ON 0 = OFF **Range:** 0000 = All OFF to 1111 = All ON **Default:** 0

Example: If you want Events 1 & 2 ON, and Events 3 & 4 OFF, press the UP or DOWN key to cycle through the binary options until you reach 0011. Remember that 1 = ON and 0 = OFF.

Press the menu key to advance to the next step. To exit the Program mode, press  and the Time key **12**.

Error Clear: This parameter only appears if errors exist. Pressing the temperature key clears any system errors appearing in the display. The display stops alternating, and the alarm output is enabled.

Alarm Clear: This parameter only appears if alarms exist, and your unit is configured for alarms. Pressing the temperature key clears any alarm conditions if the condition is corrected. The display stops alternating the alarm message, and the alarm output is enabled.

Lock: Selects the level of operator lockout.
LOC 0: All menu parameters may be viewed or changed.

LOC 1: All menu parameters may be viewed, but *none* can be changed.
Range: 0 - 1 **Default:** 0

Display alternates between parameter and programmed data.

SP _

325

SP _

350

t _

02:45

E _

4321

Ec

Ac

LOC

1

Program Chart

Table 1 -
Program Mode
Master Step Chart

Menu #	Step #	Zone 1 Set Point °F/°C	Zone 2 Set Point °F/°C	Time HR:MN or MN:SEC	Event
1	1			:	
	2			:	
	3			:	
2	1			:	
	2			:	
	3			:	
3	1			:	
	2			:	
	3			:	
4	1			:	
	2			:	
	3			:	
5	1			:	
	2			:	
	3			:	
6	1			:	
	2			:	
	3			:	
7	1			:	
	2			:	
	3			:	
8	1			:	
	2			:	
	3			:	
9	1			:	
	2			:	
	3			:	
10	1			:	
	2			:	
	3			:	
11	1			:	
	2			:	
	3			:	
12	1			:	
	2			:	
	3			:	

Chapter 4 The Operation Mode

From the Operation mode, you can start a menu by pressing the appropriate number (menu) key, provided you are within the guard band (READY LED lit). Refer to the Seires 733/734 Service Manual for more information on the guard band. You can also view the process time and temperature of the last menu used. Menu 1, Step 1 is the default. Once a menu is initiated, the time remaining is also visible here.

From the Operation mode, you can also enter the Monitor or Review mode. For more information, see the following page.

= Parameter may not appear depending on control configuration and model number.

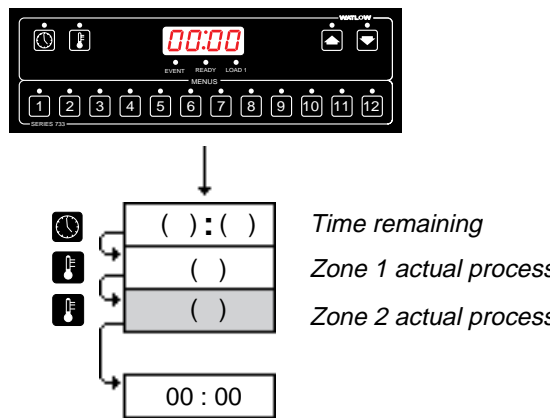



Figure 3 - The Operation Mode

Operation Parameters

Time Remaining: Represents the running time left in the selected menu. Displayed in hours/minutes OR minutes/seconds. This is the *total* menu time.

():()

Zone 1 Actual Process Temperature: Press the Temperature key  once to display the current value of the process variable for Zone 1. The appropriate zone LED will be lit if you have a dual zone control. Displayed in °F or °C.

()



Zone 2 Actual Process Temperature Press the Temperature key  again and the current value of the process variable for Zone 2. The appropriate zone LED will be lit if you have a dual zone control. This parameter only appears if your unit is dual-zone. Displayed in °F, °C, or units.

()

Running a Menu

Press the appropriate menu key **6**, that menu is activated. The LED's above the Time key and menu key are lit. The time programmed for each step in the menu is added together and begins counting down. Once the combined menu time is complete, the audible alarm sounds and the menu LED flashes. Press the menu key again to stop the audible alarm. If not, the alarm will sound for 15 seconds. Before a menu can be started, menu time must be programmed.



Viewing Temperature While Running a Menu

- To view a menu's process temperature while executing a program, press the temperature key .
- The display shows the temperature for Zone 1 **80**.
- Press the Temperature key  again and the Zone 2 process temperature is displayed.
- Press the Time key  to return to your menu countdown time.

Stopping a Menu





- To stop a running menu, press the active menu key.
- The display reverts back to **0000**.
- The 733/734 now controls at the temperature **80**.

Entering The Review Mode

- Press the Temperature key  for 5 seconds. You are in the Review mode. When a menu is running, you will not effect the menus program status.
- The **MENU** prompt is displayed. Press the menu to review.
- Press the Time key  to cycle through the selected menu.
- To exit the Review mode, press any menu key. The control reverts to the last active menu and/or step. To review more than one menu, exit the Review mode and re-enter.
- After 1 minute with no key activations, the unit reverts to the Operation mode.

Entering the Monitor Mode

The Monitor Mode displays the current set point(s), time, and events of an active menu without interrupting the menu operation. If no menu is active, it displays information from the last menu step which was running, or defaults to Menu 1, Step 1.

- Press the  Time key for 5 seconds.
- The display reads the current step **STEP_**.
- Press the Time key , the display reads Zone 1's current set point **325**.
- The Temperature key LED is lit. The Zone 1 LED is also lit if you have a dual zone control.
- Press the Time key  to advance to the next parameter. If you have a dual zone unit, the Zone 2 LED is lit and the display reads the current set point **350**.
- Press the Time key  and the current step time is displayed **1:06**.
- Press the Time key  again and the event status is displayed **10:10**.
- You can enter the Monitor mode whenever you are running a menu.
- To exit the Monitor mode, press any key.

Chapter 5 Alarm & Error Codes

Using Alarms

The Series 733/734 has two alarm types, Process or Deviation. A **Process alarm** sets an absolute temperature. When the process exceeds that absolute temperature limit an alarm occurs. The Process alarm set points may be independently set high and low.

A **Deviation alarm** alerts the operator when the process strays too far from set point. The operator can enter independent high and low alarm settings. The set point is the reference for the deviation alarm. Any change in set point causes a corresponding shift in the deviation alarm. **Example:** If your set point is 100°F, and a deviation alarm set at +7°F as the high limit, and -5°F as the low limit, the high alarm trips at 107°F, and the low alarm at 95°F. If you change the set point to 130°F, the alarms follow the set point and trip at 137°F and 125°F.

Both process and deviation alarms can be latching or non-latching. When the alarm condition is removed a **non-latching alarm automatically** clears the alarm output. You must **manually clear a latching alarm**. See below.



NOTE:
A dash "_" can be either a 1 or 2 which represents Zone 1 or Zone 2 respectively.



Flashing "LO_" or "HI_" in the display indicates an alarm. The display alternately shows information from the current parameter and the "LO_" or "HI_" alarm message at one second intervals. If an alarm condition exists, the alarm output is de-energized. An alarm condition does not effect the control output.





To clear an alarm...

- **First correct the alarm condition, then...**

- **If the alarm is latching...**

Clear it manually as soon as the process temperature is inside the alarm band (below A_HI and above A_LO).

Enter the Program mode by pressing the   keys simultaneously for 3 seconds.

Press the Menu 12  key once. Next, press the Time key . The Ac (Alarm Clear) prompt is displayed. Press the Temperature key  and the alarm is cleared. Pressing the Time key  twice, takes you back to the Operation mode .

- **If the alarm is non-latching...**



The alarm clears itself automatically as soon as the process temperature is 3°F inside the fixed alarm limit.

Alarm Silencing is available with either the process or deviation alarm in latching and non-latching mode. On initial power up, alarm silencing disables the alarm message and the alarm output relay. Once the process value crosses into the "safe" region, the latching or non-latching alarm is enabled. Any future deviation outside this safe band triggers an alarm message and the alarm output relay de-energizes. On dual zone controls, both process values must cross into the safe region before either the latching or non-latching alarm is enabled.



NOTE:
An alarm display will be masked by an error condition or when the control is in the Setup, Service or Calibration menus.

To mask an alarm ...

- **When the SIL parameter is ON...**
- Press the Temperature key . This masks or "snoozes" the alarm message for 30 seconds, and energizes the alarm output relay.
- **When the SIL parameter is OFF...**
- Press the Temperature key . This masks or "snoozes" the alarm message for 30 seconds, but **does not** energize the alarm relay.

Error Code Messages

The error code is visible in the display and alternates with the current display at a 3 second rate. The list below outlines the standard error codes associated with the Series 733/734. They are designed to isolate specific problem areas and aid in troubleshooting your control. If the problem persists, consult the factory.

Problem	Probable Cause	Solution
Er01 - ROM (Read Only Memory) checksum error	Internal ROM is defective.	<ul style="list-style-type: none"> • Cycle power
Er02 - RAM (Random Access Memory) checksum error	Internal RAM is defective.	<ul style="list-style-type: none"> • Cycle power
Er03 - Ambient sensor error	Ambient temperature is below 32°F/0°C Factory calibration parameters have been altered.	<ul style="list-style-type: none"> • Check ambient temperature at the control. • Restore factory calibration parameters. See Calibration section.
Er04 - Configuration error	Defective microprocessor	<ul style="list-style-type: none"> • Cycle power
Er05 - EEProm error	Power loss while storing data.	<ul style="list-style-type: none"> • Cycle power
Er06 - Zone 1 A/D (Analog to Digital Converter) Underflow error	<ul style="list-style-type: none"> • Incorrect sensor type • Measuring temperature outside the sensor range • Reversed sensor leads 	<ul style="list-style-type: none"> • Check the InP1 parameter. Verify it matches your sensor.
Er07 - Zone 1 A/D overflow error	Open sensor	<ul style="list-style-type: none"> • Check the InP1 parameter. Verify it matches your sensor.
Er08 - Zone 2 A/D (Analog to Digital Converter) Underflow error	<ul style="list-style-type: none"> • Incorrect sensor type • Measuring temperature outside the sensor range 	<ul style="list-style-type: none"> • Check the InP2 parameter. Verify it matches your sensor.
Er09 - Zone 2 A/D overflow error	Open sensor	<ul style="list-style-type: none"> • Check the InP2 parameter. Verify it matches your sensor.



WARNING:
Electrical noise or a noise event, excess environmental moisture or temperature, or vibration may cause Series 733/734 errors to occur. If the cause of an error is not otherwise apparent, check for these.

Table 2 - Error Code Troubleshooting



NOTE:
For Er06 through Er09, always check the sensor and connections for a reversed or open sensor before trying the solution listed.

Error Codes









Table 2 -
Continued

NOTE:
For Er10 through Er14, first check the sensor and connections for a reversed or open sensor before trying the solution listed.

NOTE:
Er06 through Er09, and Er11 through Er14 are self clearing errors if the condition that caused the alarm has been taken care of.

Problem	Probable Cause	Solution
Er10 - Stack overflow error	Microprocessor error	<ul style="list-style-type: none"> • Cycle power
Er11 - Zone 1 open sensor error	Open sensor	<ul style="list-style-type: none"> • Check the InP1 parameter. Verify it matches your sensor.
Er12 - Zone 1 shorted sensor	<ul style="list-style-type: none"> • Incorrect sensor type • Measuring temperature outside the sensor range 	<ul style="list-style-type: none"> • Check the InP1 parameter. Verify it matches your sensor.
Er13 - Zone 2 Open sensor	Open sensor	<ul style="list-style-type: none"> • Check the InP2 parameter. Verify it matches your sensor.
Er14 - Zone 2 shorted sensor	<ul style="list-style-type: none"> • Incorrect sensor type • Measuring temperature outside the sensor range • Reversed sensor leads 	<ul style="list-style-type: none"> • Check the InP2 parameter. Verify it matches your sensor.
Er15 - Zone 1 loop error	<ul style="list-style-type: none"> • Faulty heater or gas valve • Shorted sensor • Faulty output switching device • Blown fuse to heater • Incorrect Pb1 value for thermal system 	<ul style="list-style-type: none"> • Check heater or gas valve • Check sensor • Check output switching device • Check fuse to heater • Auto-tune the control
Er16 - Zone 2 loop error	See Er15 Probable Cause above. <ul style="list-style-type: none"> • Incorrect Pb2 value for thermal system 	See Er15 Solution above. <ul style="list-style-type: none"> • Auto-tune the control

Error Code Actions

- **Error codes will result in these conditons:**
 - The alarm outputs are in their alarm state (de-energized).
 - The display alternately flashes the process value and error code.
 - All keys are inactive except for the Temperature key . This key snoozes the error code and display for 30 seconds.
 - The above conditions occur regardless of the LOC value, or the presence of the Setup, Service or Calibration Menus.
- **To clear a corrected error...**
 - Cycle power to the control. *OR*
 - Enter the Program mode by pressing the   keys simultaneously for 3 seconds.
 - Press the Menu 12 key  once.
 - Press the Time key . The EC (Error Clear) prompt is displayed.
 - Press the Temperature key , and the error is cleared. Press the Time key  twice, and you're back to the Operation mode .

A, B

Actual Temperature, 9
 Advancing to the Next Menu, 6
 Alarm Clear, 5 - 7
 Alarm, Masking, 4, 13
 Ac Parameter, 7

C

Changing Data, 6

D

Diagnostic LED's, 4
 Displays, Digital, 4
 Down key, 4

E

E __, 7
 Ec Parameter, 7
 Entering,
 a Menu, 6
 the Monitor Mode, 6
 Event,
 LED, 4
 Parameter, 7
 Exit the Program Mode, 6
 Error Clear, 5 - 7
 Events, 7

F, G

General Description, 3
 Guard Band, 4

K

Keys, 4

L

LED's, 4
 LOAD 1 LED, 4
 LOC parameter, 7

M

Menu Keys, 4
 Monitor Mode, 4, 11
 Masking Alarms, 4, 13
 Model Number, 19

N

nEnU prompt, 10

O

Ordering Information, 19
 Overview, 3
 Operation
 Mode, 9
 Parameters, 9

P

Program,
 Chart, 8
 Mode, 5,6
 Parameters, 7
 Process Temperature, 9

Q, R

READY LED, 4
 Review Mode, 10
 Running a Menu, 10

S

Snooze, 4, 13
 SP_ parameter, 5, 7
 Scrolling Menus, 6
 Selecting Data, 6
 Specifications, 18
 Stopping a Menu, 10

T

t __, 7
 Time Remaining, 9
 Time Key, 4, 6, 9
 Temperature Key, 4
 Time Parameter, 7

U

Up Key, 4

V, W, X, Y

Viewing Temperature, 10
 Viewing Program Status, 10

Z

Zone 1, 4, 7, 9
 Zone 2, 4, 7, 9
 Zone LED's, 4

Notes

Declaration of Conformity

WATLOW CONTROLS

124 1 Bundy Boulevard
Winona, Minnesota 55987
USA

Declares that the following product:

Designation: Series 733 / 734
Model Number: 733A-4BB1-AAAG
Classification: Electronic Incorporated Class III temperature controller,
Type 2C action, for use in light industrial environment
Rated Voltage: 24V~ (VAC)
Rated Current: 0.250A
Rated Frequency: 50/60 Hz
Maximum Power Input: 15 Watts

Meets the essential requirements of the following European Union Directive(s) using the relevant section(s) of the normalized standards and related documents shown:

89/336/EEC Electromagnetic Compatibility Directive

EN 50082-1: 1992 EMC Generic immunity standard, Part 1: Residential, commercial, and light industry

IEC 801-3: 1984 Radiated immunity

IEC 801-5: 1991 Surge immunity

EN 50082-2: 1995 EMC Generic immunity standard, Part 2: Industrial environment

EN 6 1000-4-2: 1995 Electrostatic discharge

EN 6 1000-4-4: 1995 Electrical fast transients

ENV 50141: 1993 Conducted immunity

EN 50081-2: 1994 EMC Generic emission standard, Part 2: Industrial environment

EN 55011: 1991 Limits and methods of measurement of radio disturbance characteristics of industrial, scientific and medical radio-frequency equipment (Class B)

73/23/EEC Low- Voltage Directive

EN 60730-1: 1993 Automatic electrical controls for household and similar use, Part 1: General requirements

Winona, Minnesota, USA

Place of Issue

October 26, 1995

Date of Issue

W73X-ECEN-0000 Rev A00

Norman L. Ganion

Name of Authorized Representative

Manager, Quality Assurance

Title of Authorized Representative

Signature of Authorized Representative

Specifications

Control Mode

- Single or dual input, single or dual output, single alarm.
- EIA/TIA-422A, EIA/TIA-423A, or EIA/TIA-485 data communications.
- ON/OFF: Determined by the HYSX parameter for Outputs 1 and 2.
- PID Parameters:
 - Proportional band: 0 to 999°F/0 to 555°C/0 to 999 units.
 - Reset: 0.00 to 9.99 repeats per minute.
 - Rate: 0.00 to 9.99 minutes.
 - Cycle time: 1 to 60 seconds.

Operator Interface

- Membrane front panel.
- Single, four-digit 0.56" (14 mm) LED displays.
- TIME, TEMPERATURE, UP/DOWN & 1-12 menu keys.

Input

- Thermocouple, RTD and electrical process input.
- Automatic cold junction compensation for thermocouple.
- RTD input, 2- or 3-wire, platinum, 100 @ 0°C, software selectable: JIS curve #3916 (0.003916 / °C) or DIN curve #3850 (0.003850 / °C).
- Sensor break protection de-energizes control outputs to protect system.
- Grounded or ungrounded sensors. **(Dual input requires at least one ungrounded t/c. See Chapter 1 of the Series 733/734 Service Manual.)**
- °F, °C or process variable units are user selectable.
- Operating ranges user selectable.

J t/c:	32 to	1382°F	or	0 to	750°C
K t/c:	32 to	2282°F	or	0 to	1250°C
E t/c:	32 to	1220°F	or	0 to	660°C
RTD:	32 to	1112°F	or	0 to	600°C
- Process: -500 to 3500 units

Primary Output (Zone 1)

- Solid-state Relay, Form A, 0.4A @ 120/208/240V~ (VAC), 30VA pilot duty @ 120/208/240V~ (VAC), opto-isolated, zero-cross switching. Off state impedance is 20K minimum with contact suppression, 31M without contact suppression.
- Electromechanical Relay, Form A, 1A @ 24/120/208/240V~ (VAC), 1/8 hp. @ 120/240V~ (VAC), 125VA pilot duty @ 24/120/208/240V~ (VAC). Off state impedance is 20K minimum. 200m contact resistance, maximum.
- Switched DC, 500 minimum load resistance, 1K load, 9mA minimum, 22mA maximum, non-isolated.
- 0-20mA/4-20mA reverse or direct into a 600 maximum load impedance, non-isolated.
- 0-5V= (VDC)/0-10V= (VDC) reverse or direct into a 10K minimum load impedance, non-isolated.

Secondary Output (Zone 2)

- Solid-state Relay, Form A, 0.4A @ 120/208/240V~ (VAC), 30VA pilot duty @ 120/208/240V~ (VAC), opto-isolated, zero-cross switching. Off state impedance is 20K minimum with contact suppression, 31M without contact suppression.
- Electromechanical Relay, Form A, 1A @ 24/120/208/240V~ (VAC), 1/8 hp. @ 120/240V~ (VAC), 125VA

pilot duty @ 24/120/208/240V~ (VAC). Off state impedance is 20K minimum. 200m contact resistance, maximum.

- Switched DC, 500 minimum load resistance, 1K load, 9mA minimum, 22mA maximum, non-isolated.
- 0-20mA/4-20mA reverse or direct into a 600 maximum load impedance, non-isolated.
- 0-5V= (VDC)/0-10V= (VDC) reverse or direct into a 10K minimum load impedance, non-isolated.

Alarms

- Electromechanical Relay, Form A, 1A @ 24/120/208/240V~ (VAC), 1/8 hp. @ 120/240V~ (VAC), 125VA pilot duty @ 24/120/208/240V~ (VAC). Off state impedance is 20K minimum. 200m contact resistance, maximum.
- Latching or non-latching.
- Process or deviation.
- Separate high and low values.
- Alarm silencing (inhibit) on power up for alarm.

Event Outputs

- Switched DC, non-isolated, 5V= (VDC), 5mA maximum.

Accuracy

- Calibration Accuracy & Sensor Conformity: $\pm 0.1\%$ of span, $\pm 1\text{LSD}$, $77^\circ\text{F} \pm 5^\circ\text{F}$ ($25^\circ\text{C} \pm 3^\circ\text{C}$) minimum.
- Accuracy Span: Normally 1000° minimum span.
- Temperature Stability: $< 0.2^\circ\text{F}/^\circ\text{F}$ ($0.2^\circ\text{C}/^\circ\text{C}$) change in ambient.
- Voltage Stability: $\pm 0.01\%$ of span / % of rated line voltage.

Communications

- Serial data communications.
- EIA/TIA-422A or EIA/TIA-423A (EIA/TIA-232C compatible) or EIA/TIA-485.
- ANSI X3.28 protocol, or XON/XOFF protocol.
- Isolated.

Agency Approvals

- UL® 873, File #E43684.
- CSA Certified, File #LR30586, C22.2.
- Select models CE approved. Consult factory for details. Electronic Incorporated Class III Control, Type 2 action.

Connectors

- Compression type screw terminals and universal Mate-n-Lok.

Power

- 24V~ (VAC) +10%, - 15%.
- 50 to 60 Hz $\pm 3\%$.
- Consumption 6 - 10VA.
- For CE-approved models, input power limited to 15 watts maximum. All components are rated for a maximum of 15 watts.

Operating Environment

- 32 to 176°F/0 to 80°C.
- 0 to 90% RH, non-condensing.

Dimensions

733A-xxxx-xxxx (horizontal) models:

- Height: 3.28" 83 mm
- Width: 10.66" 271 mm
- Depth: 2.00" 51 mm

734A-xxxx-xxxx (vertical) models:

- Height: 10.66" 271 mm
- Width: 3.28" 83 mm
- Depth: 2.00" 51 mm

7 3 A - - A A

733/734 = One or two channel microprocessor-based, time and temperature control; 24V~ (VAC) power input.
 *Order power supply and connector kit(s) separately below.

Display Orientation _____

- 3 = Horizontal
- 4 = Vertical

Display Location _____

- A = Integral (local)

Input Type _____

- 1 = Single thermocouple (type J, K E)
 - 2 = Single RTD 1°, curve selectable
 - 4 = Dual thermocouple (type J, K, E); *Order output types 1 & 2*
 - 5 = Dual RTD 1°, curve selectable; *Order output types 1 & 2*
 - 6 = Dual Input: Channel 1 thermocouple (type J, K, E); and Channel 2 process (0-5V= (VDC), 0-10V= (VDC), 0-20mA, 4-20mA), *Order output types 1 & 2*
- Dual-zone units must use ungrounded thermocouples.**

Output 1 Type _____

- B = Solid-state relay with RC suppression, form A, 0.4A
- C = Switched DC, open collector, non-isolated
- D = Mechanical relay, form A, 1A, with suppression
- E = Mechanical relay, form A, 1A, without suppression
- F = Process, 4-20mA, non-isolated
- H = Process, 0-5V= (VDC), non-isolated
- K = Solid-state relay without RC suppression, form A, 0.4A

Output 2 Type _____

- A = None
- B = Solid-state relay with RC suppression, form A, 0.4A
- C = Switched DC, open collector, non-isolated
- D = Mechanical relay, form A, 1A, with suppression
- E = Mechanical relay, form A, 1A, without suppression
- F = Process, 4-20mA, non-isolated
- H = Process, 0-5V= (VDC), non-isolated
- K = Solid-state relay without RC suppression, form A, 0.4A

Event Inputs/Outputs _____

- 0 = None
- 1 = 4 Event outputs, switched DC, non-isolated (custom only)

Alarm _____

- A = None
- D = Single mechanical relay, form A, 1A, with suppression

Communications (Isolated) _____

- A = None
- B = EIA/TIA-422 or EIA/TIA-423
- D = EIA/TIA-485

Options _____

- AA = Standard Single Display

Power Supply, Power Connector and Event Input/Output Accessory Kits (Order separately here.)

Part No.	Description
A001-0249-0001 =	120V~ (VAC) - 24V~ (VAC), stepdown transformer, Class 2, quick connect terminals included.
A001-0249-0002 =	208/240V~ (VAC) - 24V~ (VAC), stepdown transformer, Class 2, quick connect terminals included.
A001-0250-0012 =	Power input connector kit, 12-pin connector assembly, wire not included.
A001-0250-0009 =	Event input/output connector kit, 9-pin connector assembly, wire not included.

Watlow Series 733/734 User's Manual

Watlow Controls, 1241 Bundy Blvd., P.O. Box 5580, Winona, MN 55987-5580, 507/454-5300, Fax: 507/452-4507