

Fits Virtually Entire Range of Immersion and Air Heating Applications

Available in single- or double-ended termination styles, the versatile and economical WATROD™ tubular heating element from Watlow® lends itself to virtually the entire range of immersion and air heating applications.

The single-ended WATROD tubular design has both terminals at one end. The opposite end is sealed. Flexible lead wires are 12 in. (305 mm) crimp connected to the terminal pin and have silicone-impregnated fiberglass oversleeves.

The double-ended WATROD, with its round cross-sectional geometry, is highly adaptable for bending—especially when bending is performed in the field. Watlow's double-ended MULTICOIL™ tubular elements offer various combinations of resistor coils and thermocouples inside one sheath. They have the ability to sense the heater's internal temperature accurately every time, or offer three-phase capability in one element.

Both single- and double-ended WATRODs share many construction features delivering long life—the resistance wire is centered in the heater sheath and electrically insulated with compacted, high-grade magnesium oxide for superior heating performance.

WATROD heating elements have a variety of mounting and termination options making them highly popular among industrial customers.

Performance Capabilities

Single-Ended WATROD

- Watt densities up to 45 W/in² (6.9 W/cm²)
- UL® and CSA component recognition up to 240VAC
- Alloy 800/840 and stainless steel sheath temperatures up to 1200°F (650°C)

Double-Ended WATROD

- Watt densities up to 120 W/in² (18.6 W/cm²)
- UL® and CSA component recognition up to 600VAC
- Alloy 800/840 sheath temperatures up to 1600°F (870°C)
- Stainless steel sheath temperatures up to 1200°F (650°C)
- Steel sheath temperatures up to 750°F (400°C)
- Alloy 800 sheath temperatures up to 1800°F (982°C)

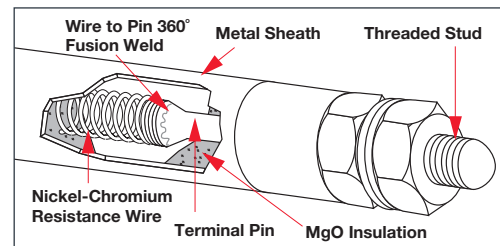
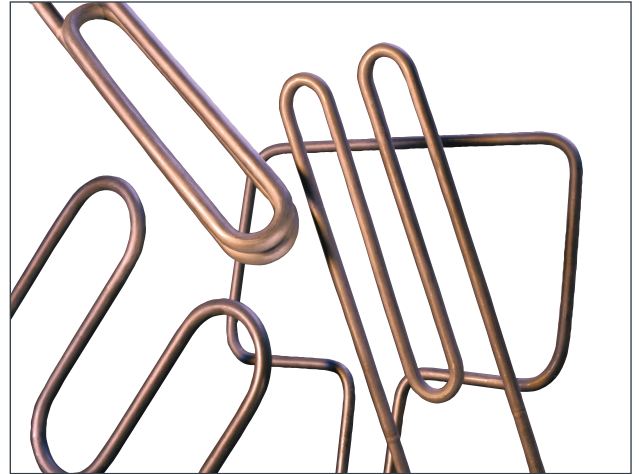

Features and Benefits

Precision wound nickel-chromium resistance wire

- Distributes heat evenly to the sheath for optimum heater performance

Silicone resin seals

- Protects against moisture contamination and is rated to 221°F (105°)

MgO insulation filled sheath

- Maximizes dielectric strength, heat transfer and life

Standard sheath materials

- Steel, 304 and 316 stainless steel, alloy 800/840 and alloy 600

53 standard bend formations

- Allows forming the heating element to the application. Spirals, compound bends and multi-axis and multi-plane configurations available

Stainless steel studs

- Fusion welded to terminal pins for mechanical strength

Popular termination, mounting and moisture seal options available, see heater catalog for details.

Options

Moisture Resistant Seals

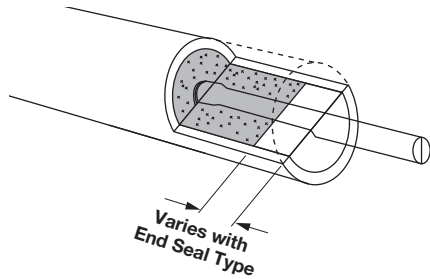

WATROD's MgO insulating material is hygroscopic. To control the rate of moisture entering the heater, an appropriate moisture seal must be used. Choosing the correct seal is important to the life and performance of the heater. All materials have varying rates of gas vapor transmission. Be sure the maximum continuous use temperature is not exceeded at the seal location. Most end seals are applied with a small cavity in the end of the heater. The seal will also help prevent arcing at the terminal ends.

Zoned Heaters

Only single zone heaters are available.

External Finishes

Bright Annealing

Bright annealing is a process that produces a smooth, metallic finish. It is a special annealed finish created in a non-oxidizing atmosphere. This finish is popular in the pharmaceutical and food and beverage markets.

To order, specify **bright annealing**.

Passivation

During the manufacturing process, particles of iron or tool steel may become embedded in the stainless steel or alloy sheath. If not removed, these particles may corrode, produce rust spots and/or contaminate the process. For critical sheath applications, passivation will remove free iron from the sheath.

To order, specify **passivation**.

Ceramic-to-Metal End-Seal

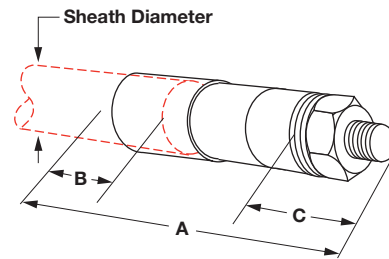

Ceramic-to-metal end-seals with threaded stud terminations provide an air-tight seal for continuous terminal temperatures up to 500°F (260°C). Watlow does not recommend this seal if terminations are exposed to temperatures exceeding 500°F (260°C).

Sheath Diameter in. (mm)	A in. (mm)	B in. (mm)	C in. (mm)	Thread Size
0.260 (6.6)	1 ¹¹ / ₁₆ (42.9)	1/2 (13)	1 ³ / ₃₂ (10.32)	#8-32
0.315 (8.0)	1 ⁷ / ₈ (47.6)	1/2 (13)	1 ³ / ₃₂ (10.32)	#10-32
0.430 (10.9)	2 ¹ / ₈ (54.0)	1/2 (13)	1 ³ / ₃₂ (10.32)	#¼-28

End-Seal Options

End-Seal	Part Number	Color	UL® Recognition	Max. Cont. Use Temperature	Typical or General Usage/Application
Standard Epoxy	EC	Cream	Yes	194°F (90°C)	Long term stable insulation resistance
Intermediate Epoxy	EB	Gray	Yes	356°F (180°C)	Long term stable insulation resistance
High-Temp. Epoxy	HTE	Amber	No	450°F (232°C)	Long term stable insulation resistance
Silicone Resin	SR	Clear	Yes	221°F (105°C)	General usage on tubular products - porous
Silicone Fluid	SF	Clear	No	392°F (200°C)	Moisture resistance of the MgO, or high temperature ceramic seal (storage only) - porous
Lavacone	LC	Dark Brown	Yes	221°F (105°C)	Porous seal for the FIREBAR
Silicone Rubber RTV	RTV	Red-Orange	Yes	392°F (200°C)	General usage on FIREBAR applications - porous
High-Temperature Ceramic	HTC	White Ceramic	Yes	2800°F (1538°C)	Very high-temperature applications - for extremely low transmission rate

Terminations

Terminations

Double-ended WATROD elements are available with a variety of terminations. Single-ended WATROD elements are available with only flexible lead wires.

The following table and illustrations detail the terminations available with double- or single-ended WATRODs—for each available sheath diameter.

Flexible lead wires are 12 in. (305 mm), Sil-a-Blend® 390°F (200°C) unless otherwise specified. Insulation options include TGGT 480°F (250°C) plus other temperature ratings. Contact a Watlow representative.

Overmolds are available for flexible lead wires only. Available in silicone rubber 390°F (200°C) and neoprene 212°F (90°C). Contact a Watlow representative.

WATROD Element	Sheath Diameter in. (mm)	Threaded Stud	Screw Lug (Plate)				Quick Connect (Spade)			Flexible Lead Wires
		A	B	C	D	E	F	G	H	
Double-Ended	0.260 (6.6)	#6-32	Yes	Yes	Yes	Yes	Yes	Yes	Yes	Yes
	0.315 (8.0)	#10-32	Yes	Yes	Yes	Yes	Yes	Yes	Yes	Yes
	0.335 (8.5)	#10-32	Yes	Yes	Yes	Yes	Yes	Yes	Yes	Yes
	0.375 (9.5)	#10-32	Yes	Yes	Yes	Yes	Yes	Yes	Yes	Yes
	0.430 (10.9)	#10-32	Yes	Yes	Yes	Yes	Yes	Yes	Yes	Yes
	0.475 (12.1)	#10-32	Yes	Yes	Yes	Yes	Yes	Yes	Yes	Yes
	0.490 (12.5)	#10-32	Yes	Yes	Yes	Yes	Yes	Yes	Yes	Yes
Single-Ended	0.375 (9.53)	No	No	No	No	No	No	No	No	Yes
	0.430 (10.9)	No	No	No	No	No	No	No	No	Yes
	0.475 (12.1)	No	No	No	No	No	No	No	No	Yes
	0.490 (12.5)	No	No	No	No	No	No	No	No	Yes

Bend Formations (See Heater Catalog for more details)

Double-Ended WATROD

Double-ended WATROD heating elements can be formed into spirals, compounds, multi-axis and multi-planes from 36 common bend configurations. Custom bending with tighter tolerances can be made to meet specific application needs.

Formation is limited by the minimum bend radius (R) and the straight length (F) required beyond the bend. In order to locate the end of a heated length within a bend, the radius must be 3 in. (76 mm) or larger. Additionally, overall length tolerance (T) must be included in one or more of the straight lengths.

Single-Ended WATROD

Watlow does not recommend field bending single-ended WATROD elements. Formation is limited by the minimum radius of a bend (R) and the straight length (F) beyond the bend. The radius must be 3 in. (75 mm) or more for the heated length's end to be inside a bend.

Additionally, the overall length tolerance (T) must be provided for in one or more of the specified lengths.

Mounting Methods

Brackets - Standard Shown

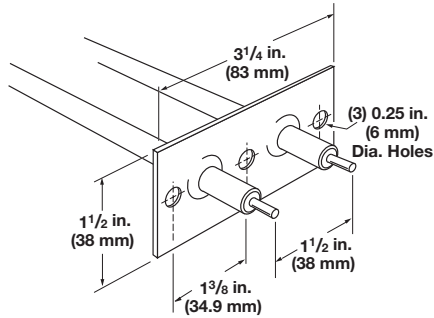

A 0.065 in. (1.7 mm) thick stainless steel bracket provides element mounting in non-pressurized applications. Attached to the heater sheath, these brackets are not suited for liquid-tight mountings. The bracket is located ½ in. (13 mm) from the sheath's end, unless otherwise specified.

Single Leg Bracket - Standard

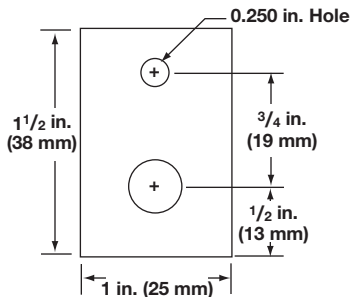

A 1½ in. (38 mm) x 1 in. (25 mm) wide x 16 gauge stainless steel bracket with one element hole and one mounting hole ½ in. (13 mm) from end.

Locator Washers

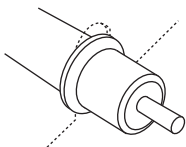

Stainless steel locator washers retain the heated area of the sheath in the work zone, while allowing for expansion and contraction during cycling.

Ceramic-to-Metal End-Seal

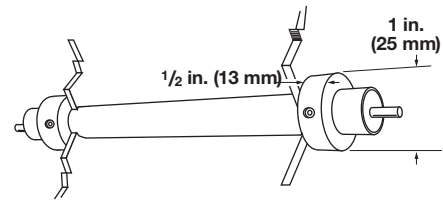

Plated steel mounting collars secure the heater sheath with set screws to serve as adjustable stops for through-the-wall mounting. Collars are shipped in bulk.

Threaded Bulkheads

A threaded bushing with flange on the heater sheath provides rigid, leak-proof mounting through the walls of tanks. A gasket, plated steel washer and hex nut are included. The threaded end of the bushing is flush with the sheath's end unless otherwise specified. Threaded bulkheads are available in brass, steel or stainless steel.

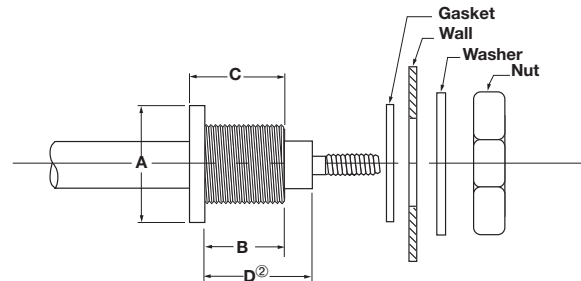

Options - Extended Capability

See the current heater catalog for detailed information on extended capabilities.

Watlow® and FIREBAR® are registered trademarks of Watlow Electric Manufacturing Company.

MULTICOIL™ and WATROD™ are trademarks of Watlow Electric Manufacturing Company.

UL® is a registered trademark of Underwriter's Laboratories, Inc.

Sil-a-Blend® is a registered trademark of Radix Wire Company.

Powered by Possibility

To be automatically connected to the nearest North American Technical Sales Office:

1-800-WATLOW2 • www.watlow.com

International Technical Sales Offices:

Austria	+43 6244 20129 0	India	+91 40 6661 2700
China	+86 21 3532 8532	Italy	+39 02 458 8841
France	+33 1 41 32 79 70	Japan	+81 3 3518 6630
Germany	+49 7253 9400 0	Korea	+82 2 2169 2600

Mexico	+52 442 256 2200
Singapore	+65 6773 9488
Spain	+34 91 675 1292
Taiwan	+886 7 288 5168
UK	+44 115 964 0777