

Worry Less and Do More

Eurotherm nanodac™ Recorder/Controller

High integrity graphical data recording aids statutory compliance across regulated industries.

World class PID control for greater performance and process reliability



Eurotherm®

Product at a glance

We combined our in depth knowledge of stringent data security requirements of regulated industries with our control expertise in specialist applications such as cascade control, sterilization and carbon control to bring you world class recording and PID control in a space-saving, small box with a superb full color display.

The recording functionality within the nanodac instrument reflects our understanding of the requirements of capturing and storing electronic data. We understand that different applications have different needs and so the nanodac recorder can store your information, either in open CSV format or in a tamper resistant, checksummed format to better maintain data integrity. Whichever format you choose for your process, we have the tools to help you keep this data more secure, get it to the place you need, and in the format you require. Digital batch recording and electronic signatures helps simplify reporting and the audit process. This aids compliance with GAMP, NADCAP and HACCP/HARPC requirements.

Add to this our commitment to technological innovation, constant reinvestment in research and development, and a team of engineers who understand your process requirements and you will find in Eurotherm a partner able to flex with the demands of your business as the regulatory and audit landscape changes.

- Tamper resistant data recording methodology trusted by auditors
- Electronic signing and authorisation compliant with FDA 21 CFR Part 11
- Powerful batch functionality
- Eurotherm PID algorithm with 2 control loops
- Cascade control with advanced autotune
- Dual programmer
- High accuracy universal inputs
- Graphical wiring
- USB removable data storage facility
- Modbus TCP/IP Master/Slave
- EtherNet/IP Client or Server
- BACnet Slave
- Sterilizer Application Block
- Relative Humidity Application Block
- Steam Flow Application Block
- Zirconia Probe Application Block
- Multi-language support
- Compact design

nanodac™ Specification

General Hardware and Software

I/O Types	
Analog inputs	Four standard (eight if dual input enabled)
Digital inputs	Two as standard, One optional
Digital (logic) outputs	Two optional
Relay outputs	Two as standard, two optional
DC outputs	Three optional

Ethernet Communications	
Ethernet Communications	10/100BASE-T Ethernet (IEEE802.3)
Protocols	Modbus TCP Slave (default), Options for Modbus TCP Master, Ethernet/IP Client or Server, BACnet,SFTP/FTP
Cable type	Category 5 Shielded
Maximum Cable length	100 meters (110 yards)
Connector Type	RJ45 (Green LED illuminated = Link Connected; Amber LED Flashing = Link Activity)
Network Addressing	DHCP or Fixed (Static) IP Addressing

USB Port	
Number of ports	One at rear of instrument
Standard	USB1.1
Transmission speed	1.5Mbits/s (low speed device)
Maximum current	<100mA
Peripherals supported	Memory stick (8GB max), Barcode scanner, QWERTY keyboard

Battery Backup	
Stored Data	Time and Date only
Support Time	Minimum of 1 years with unit unpowered
Replacement period	Three years Typical
Temperature Stability	0 to 55°C $\leq \pm 3.5$ ppm
RTC Aging	First year to 10 years < 5ppm
Battery Type	Lithium/poly-carbonmonofluoride

Operator Interface	
Integrated Display	3.5" color TFT (320 pixels wide x 240 pixels high)
User interface	Four navigation push buttons (Page, Scroll, Lower and Raise)

Data Recording	
Sample Rate	8Hz (125ms)
Trend Display update rate	8Hz (125ms)
Recording Groups	1
Display points	6
Recording points	up to 34 (with Modbus Master Option)
Data Storage	50MB

nanodac™ Specification

Power supply, Isolation, Environmental and Compliance

Power Specifications	
Supply voltage	Standard: 100 to 230V ac ±15% at 48 to 62Hz Low voltage Option: 24V ac (+10% -15%) at 48 to 62Hz, or 24V dc (+20% -15%)
Power dissipation	9W (max.)
Fuse type	No internal fuse fitted
Interrupt Protection (Standard unit)	Holdup >20ms at 85V RMS supply voltage
Interrupt Protection (Low voltage unit)	Holdup >20ms at 20.4V RMS supply voltage

Control	
Control Loops	Two, plus advanced control (cascade) loop
Control Types	On/Off, PID, VPU, Cascade (Advanced Loop)
Advance Features	
Application Blocks	Zirconia, Relative Humidity, Steriliser, Steam/Mass Flow
Batch	Single Batch, six Batch Fields
Auditor	Up to 25 users with individual username, password and permissions

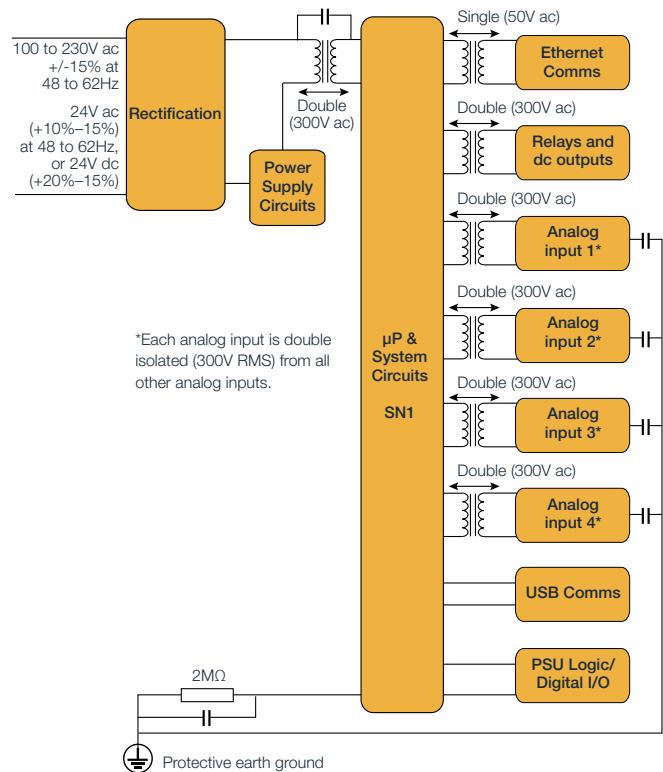

Isolation details

Environmental Specifications, Approvals and Compliance		
Operating temperature	0 to 55°C	
Storage temperature	-20 to +70°C, max rate of change 1°C per minute	
Operating humidity	5% to 85% RH non condensing	
Storage humidity	5% to 85% RH non condensing	
Front of panel protection	Standard: IP65, Washdown: IP66, NEMA12	
Back of panel protection	IP10 (International)	
Shock/vibration	To BS EN61131-2 (5 to 150 Hz. at 1g; 1 octave per min.)	
Altitude	<2000 meters	
Atmosphere	Not suitable for use in explosive or corrosive atmospheres	
Electrical safety	BS EN61010-1 (installation category II; Pollution degree 2)	
Electromagnetic compatibility (EMC)	Emissions (Standard unit)	BS EN 61326 Class B – Light industrial
	Emissions (Low voltage unit)	BS EN 61326 Class A – Heavy industrial
	Immunity	BS EN 61326 Industrial

Approvals and Compliance	
General	CE, UL and EN61010
PV Input	AMS2750 compliant
RoHS	EU; China
Packaging	BS EN61132-2 section 2.1.3.3

nanodac™ Specification

Built in I/O

Analog Inputs (An In 1-4)

Analog Inputs General	
Number of inputs	Four
Input types	dc volts, dc mV, dc mA (external shunt required), thermocouple, linear ohms, RTD (2-wire and 3-wire)
Input type mix	Freely configurable
Update rate	125ms max.
Conversion method	16 bit delta sigma
Input ranges	See individual tables
Mains rejection (48 to 62Hz)	> 95dB series mode >179dB common mode
Common mode voltage	250V ac max.
Series mode voltage	280mV at lowest range; 5V peak to peak at highest range
Input impedance	>100MΩ (40mV, 80mV, 2V ranges only) 667kΩ for input < 5.6V, 62.5kΩ for input > 5.6V (10V range only)
Overvoltage protection	±30V RMS (continuous) ±200V pk-pk between terminals (transient <1ms)
Sensor break detection	ac sensor break on each input giving quick response with no associated dc offset Recognition time<3 seconds Minimum break resistance: 5kΩ for 40mV and 80mV ranges; 12.5kΩ for 2V and 10V ranges
Isolation	300V RMS or dc (double insulation) channel to channel 300V RMS or dc (double insulation) channel to processor electronics 300V RMS or dc (single insulation) channel to ground
Dielectric strength	BS EN 61010, 1 minute type test 2500V ac channel to channel 1500V ac channel to ground

Voltage Inputs

mV and V inputs				
Low range	High range	Resolution	Calibration accuracy (instrument at 25°C)	Temperature performance
-40mV	+40mV	1.9μV	4.6μV + 0.053% of reading	13ppm of input per °C
-80mV	+80mV	3.2μV	7.5μV + 0.052% of reading	13ppm of input per °C
-2V	+2V	82μV	420μV + 0.044% of reading	13ppm of input per °C
-3V	+10V	500μV	1.5mV + 0.063% of reading	45ppm of input per °C

Thermocouple Inputs

Thermocouple Inputs	
Temperature scale	ITS90
CJC types	Off, internal, external, remote
Remote CJC source	Any analog input channel
Internal CJC accuracy	<1°C max, with instrument at 25°C
Internal CJC rejection ratio	40:1 from 25°C
Upscale/downscale drive	High, low or none independently configurable for each channel's sensor break detection

Thermocouple Types			
T/C type	Overall range (°C)	Standard	Linearization accuracy
B	0 to +1820	IEC584.1	0 to 400°C = 1.7°C 400 to 1820°C = 0.03°C
C	0 to +2300	Hoskins	0.12°C
D	0 to +2495	Hoskins	0.08°C
E	-270 to +1000	IEC584.1	0.03°C
G2	0 to +2315	Hoskins	0.07°C
J	-210 to +1200	IEC584.1	0.02°C
K	-270 to +1372	IEC584.1	0.04°C
L	-200 to +900	DIN43710:1985 (to IPTS68)	0.02°C
N	-270 to +1300	IEC584.1	0.04°C
R	-50 to +1768	IEC584.1	0.04°C
S	-50 to +1768	IEC584.1	0.04°C
T	-270 to +400	IEC584.1	0.02°C
U	-200 to + 600	DIN43710:1985	0.08°C
NiMo/NiCo	-50 to +1410	ASTM E1751-95	0.06°C
Platinel	0 to +1370	Engelhard	0.02°C
Mi/NiMo	0 to +1406	Ipsen	0.14°C
Pt20%Rh/ Pt40%/Rh	0 to +1888	ASTM E1751-95	0.07°C

nanodac™ Specification

Built in I/O

Current Inputs

mA input accuracy is based on the shunt value and voltage range. Standard mA selection uses -3 to 10V range, therefore use -3 to 10V range specifications.

mA Inputs			
Low range	High range	External shunt	Shunt accuracy
0	20mA	1Ω to 1kΩ	Dependent on shunt selection. 0.1% of input for shipped 2.49Ω shunt.

Resistance Inputs

Linear Ohms Inputs				
Low range	High range	Res	Calibration accuracy (Instrument at 25°C)	Temperature performance
0Ω	400Ω	20mΩ	120mΩ + 0.023% of reading	25ppm of input per °C

RTD Inputs

Pt100 Inputs	
Temperature scale	ITS90
Maximum source current	200μA
Range	0 to 400Ω (-200 to +850°C)
Resolution	0.05°C
Calibration accuracy	±0.31°C ±0.023% of measurement in °C at 25°C ambient
Temperature coefficient	±0.01°C/°C ±25ppm/°C measurement in °C from 25°C ambient
Measurement noise	0.05°C peak-peak with 1.6s input filter
Linearity	0.0033% (best fit straight line)
Lead resistance	0 to 22Ω matched lead resistances

RTD Types			
RTD type	Overall range (°C)	Standard	Linearization accuracy
Cu10	-20 to +400	General Electric Co.	0.02 °C
Cu53	-70 to +200	RC21-4-1966	0.01 °C
JPT100	-220 to +630	JIS C1604:1989	0.01 °C
Ni100	-60 to +250	DIN43760:1987	0.01 °C
Ni120	-50 to +170	DIN43760:1987	0.01 °C
Pt100	-200 to +850	IEC751	0.01 °C
Pt100A	-200 to +600	Eurotherm Recorders SA	0.09 °C

Digital Inputs (Dig in A and Dig in B only)

Contact Closure Input	
Closed circuit sensing current (source)	5.5mA min to 6.5mA max
Open circuit (inactive) resistance	>600Ω
Closed circuit (active) resistance	<300Ω
Update rate	8ms max

Relay Outputs (O/P4 and O/P5 only)

Form A N/O Relay Outputs	
Contact switching power (resistive)	1A max at 240V RMS +/-15%, 5mA min at 5V
Current through terminals	1A
Isolation	300V RMS or dc, double insulated from processor/comms electronics
Update rate	8ms max

nanodac™ Specification

Optional I/O

Table A1 Output Options (OPT 1 to OPT 3)		
OPT 1	OPT 2	OPT 3
L	R	R
L	R	D
L	L	R
R	D	D
D	D	D
L	L	D

Logic Input (Available in Opt 1 only)

Active (current on) Contact Closure	
Input current (input at 12V)	0mA min to 44mA max
Input current (input at 0V)	6mA (steady state) to 44mA (switch current)
Open circuit input voltage	+11V to +13V
Open circuit (inactive) resistance	>500Ω
Closed circuit (active) resistance	<150Ω
Update rate	8Hz (125ms) max

Logic Outputs (Available in Opt 1 or Opt 2)

Logic Output (current sourcing)	
Voltage Output across terminal (current on)	+11V to +13V
Voltage Output across terminal (current off)	0mV to +300mV
Short circuit output current (current on)	6mA (steady state) to 44mA (switch current)
Output source leakage current (current off)	0μA to 100μA
Update rate	8Hz (125ms) max

Relay Output (Available in Opt 1, Opt 2 or Opt 3)

Form A (N/O) Relay Outputs	
Contact switching power (resistive)	Max 2A at 230V RMS ±15%; Min 100mA at 12V
Current through terminals	2A max
Estimated mechanical life	>10,000,000 operations
Update rate	8Hz (125ms) max
Isolation	300V RMS or dc, double insulated from processor electronics

DC Outputs (Available in Opt 1, Opt 2 or Opt 3)

Voltage Output	
Output range (current)	Configurable within 0 to 20mA
Load resistance (current)	500Ω min
Calibration Accuracy (current)	<±100μA ±1% of reading
Output range (voltage, Opt 3 only)	Configurable within 0 to 10Vdc
Load resistance (voltage, Opt 3 only)	500Ω min
Calibration Accuracy (voltage, Opt 3 only)	<±50mV ±1% reading
Resolution	>11 bits
Thermal Drift	<100ppm/°C
Update Rate	8Hz (125ms) max
Isolation	300V RMS or dc, double insulated from processor electronics

Standard I/O

Fixed Dig InA/Dig InB (Contact Closure)	
Short circuit sensing current source	5.5mA (min); 6.5mA (max)
Open circuit (inactive) resistance	600Ω (min); ∞ (max)
Closed circuit (active) resistance	0Ω (min); 300Ω(max)

Fixed Form A N/O Relay Outputs (O/P4 and O/P5)	
Contact Switching Power (resistive)	Max 1A at 230V RMS ±15%; Min 100mA at 12V
Current through terminals	1A max
Estimated mechanical life	>10,000,000 operations
Update Rate	8Hz (125ms) max
Isolation	300V RMS or dc, double insulated from processor electronics

nanodac™ Specification

Terminal Wiring Details

No. of wires	Wire size		Screw terminal torque	
	mm ²	AWG	Nm	lb in
1 wire	0.205 to 2.08 mm ²	24 to 14 AWG	0.4Nm max	3.54 lb in max
2 wires	0.205 to 1.31 mm ² (inclusive)	24 to 16 AWG (inclusive)	0.4Nm max	3.54 lb in max

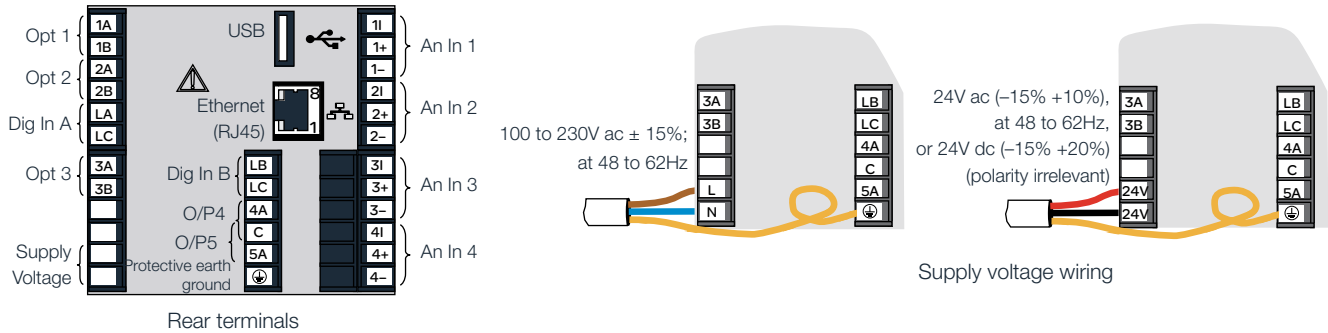

I/O Terminations

Termination details

The screw terminals accept wire sizes in the range:

Single wire 0.205 to 2.08mm² (14 to 24 AWG) 2 wires 0.205 to 1.31mm² (16 to 24 AWG) inclusive.

Screw terminals should be tightened to a torque not exceeding 0.4Nm (3.54 lb in).

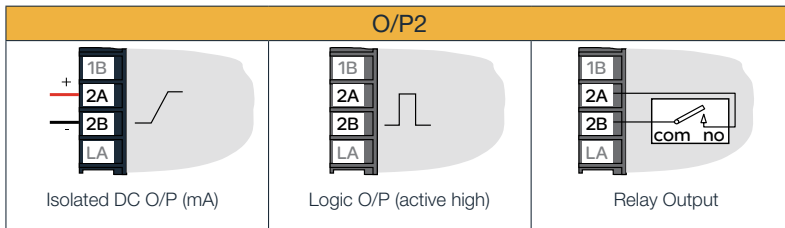
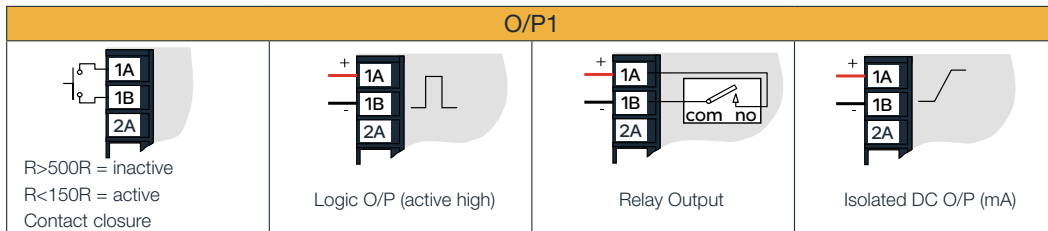

Use copper conductors only.

The power supply input is not fuse protected.

This should be provided externally.

Each wire connected to LA, LB and LC must be less than 30 metres in length.

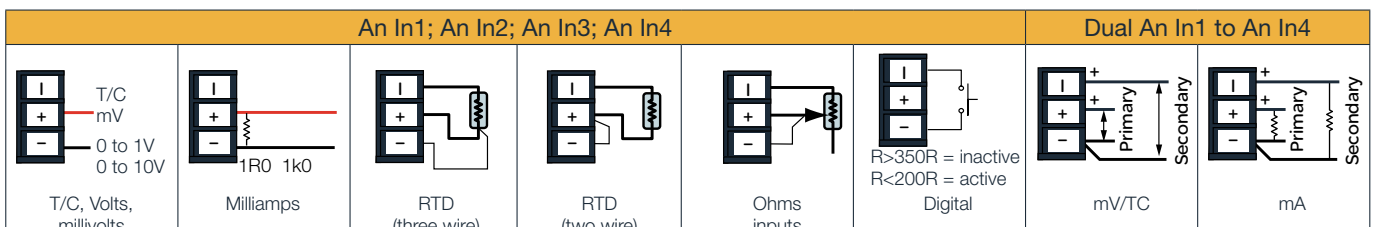
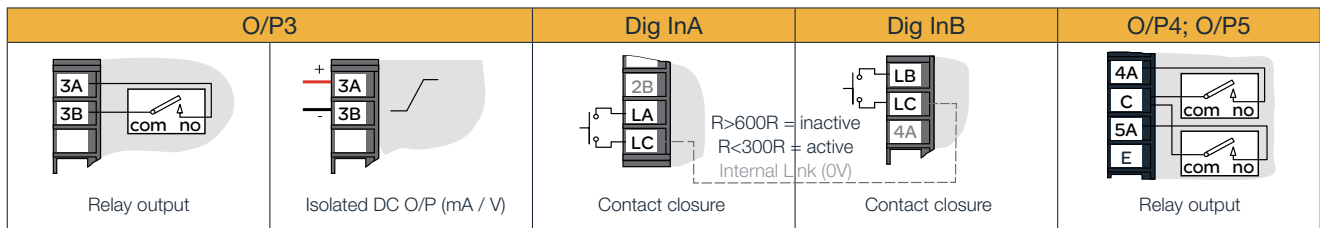

nanodac™ Specification

Mechanical Details

Dimensions	
Panel mounting	1/4 DIN
Weight	Instrument only: 0.44kg (15.52ozs)
Panel cutout dimension	92mm x 92mm (both -0.0 +0.8mm) or 3.62in x 3.62in (both -0.00 +0.03in)
Depth behind bezel:	90mm (3.54in) excluding wiring

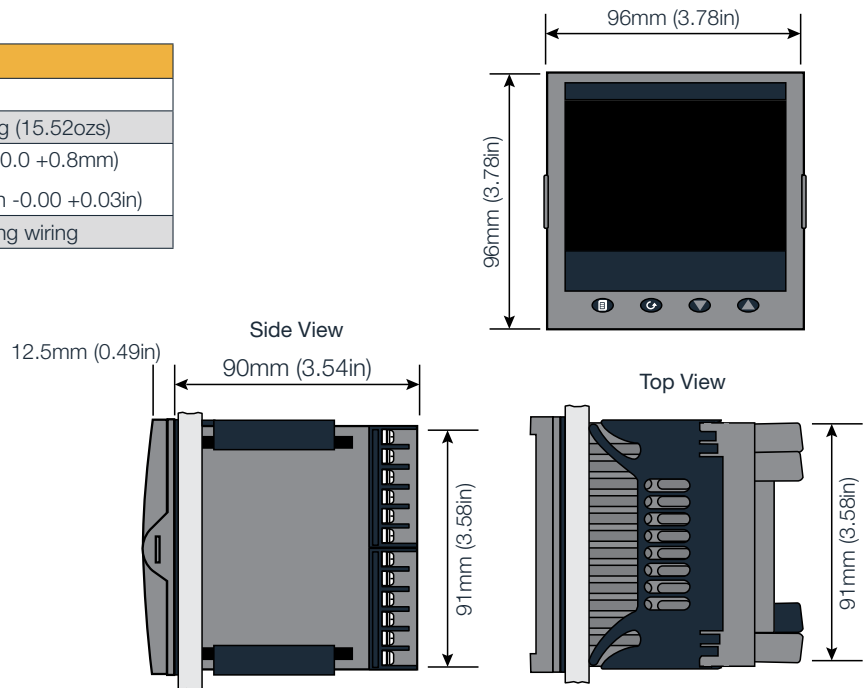

nanodac™ Order Codes

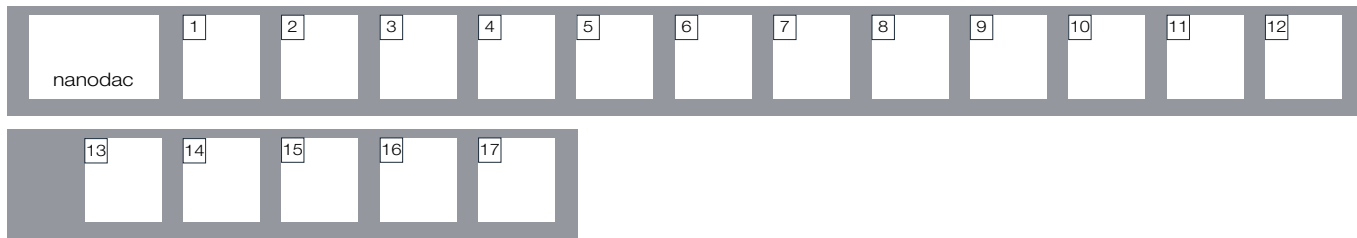

Basic Product	
NANODAC	Graphical Recorder/Controller

1 Supply Voltage	
VH	100-230V ac ±15% at 48-62Hz
VL	24V ac (+10% -15%) at 48-62Hz, or 24V dc (+20% -15%)

2 Controller	
X	None (default)
C	2 Control loops
A	Advanced control loop (includes 2 control loops)

3 Programmer	
X	None (default)
P	Dual programmer

4 Output Options 1-2-3	
LRR	Logic/Relay/Relay (default)
LRD	Logic/Relay/Iso DC output
LLR	Logic/Logic/Relay
RDD	Relay/Iso DC/Iso DC
DDD	Iso DC/Iso DC/Iso DC
LDD	Logic/Iso DC/Iso DC
LLD	Logic/Logic/Iso DC

5 Application Blocks	
XX	None
ZC	Zirconia
RH	Humidity
ST	Steriliser

6 Communications Protocol	
TS	Modbus TCP/IP slave (default)
TM	Modbus TCP/IP master
ES	EtherNet/IP client/server
BS	BACNet Server (Slave)
TB	BACNet Server (Slave) & Modbus TCP Master

7 Bezel	
SV	Silver (standard)
WD	Wash down front

8 Toolkit Blocks	
XXXX	None
BASIC	Basic toolkit blocks

9 Operating Language	
ENG	English (default)
FRA	French
GER	German
ITA	Italian
SPA	Spanish

10 OEM Security	
XXX	None
OEM	OEM Security enabled

11 Labels	
XXXX	No custom labels

12 Special	
XXXX	Default

13 Dual Input Channels	
XX	None
05	5 inputs enabled
06	6 inputs enabled
07	7 inputs enabled
08	8 inputs enabled

14 Dual Thermocouple Support	
XXX	None
TC	Dual T/C support enabled

15 Batch	
NONE	None
BATCH	Batch enabled

16 Auditor Full (21CFR11)	
NONE	None
AFULL	Auditor Full (21CFR11) enabled

17 Steam Flow Calculations	
XX	None (Default)
SF	Steam/Mass Flow Calculations

Eurotherm

Faraday Close, Worthing
West Sussex BN13 3PL
United Kingdom
Phone: +44 (0) 1903 268500

www.eurotherm.com

Eurotherm document number HA030686 Issue 11



Watlow, Eurotherm, EurothermSuite, EFit, EPack, EPower, Eycon, Chessell, Mini8, nanodac, piccolo and versadac are trademarks and property of Watlow its subsidiaries and affiliated companies. All other trademarks are the property of their respective owners.

©Watlow Electric Manufacturing Company. All rights reserved.