



Reference Data

Power Calculations (Imperial Unit)	518
Equations (Imperial Unit)	527
Wattage Requirements (Imperial Unit)	529
Power Calculations (SI Unit)	531
Equations (SI Unit)	539
Wattage Requirements (SI Unit)	541
Tubular Elements and Assembly Selection Guide	543





Power Calculations

Calculations for Required Heat Energy

The total heat energy (kWh or BTU) required to satisfy the system needs will be either of the two values shown below depending on which calculated result is larger.

1. Heat required for start up
2. Heat required to maintain the desired temperature

The power required (kW) will be the heat energy value (kWh) divided by the required start up or working cycle time. The kW rating of the heater will be the greater of these values plus a safety factor.

The calculation of start-up and operating requirements consist of several distinct parts that are best handled separately. However, a short method can also be used for a quick estimate of heat energy required. Both methods are defined and then evaluated using the following formulas and methods:

Short Method

$$\text{Start-up watts} = (P_A + P_C + \frac{2}{3} P_L) \times (1 + \text{S.F.})$$

$$\text{Operating watts} = (P_B + P_D + P_L) \times (1 + \text{S.F.})$$

P_A = Watts required to raise the temperature of material and equipment to the operating point, within the time desired

P_B = Watts required to maintain temperature of the material during the working cycle

P_C = Watts required to melt or vaporize load material during start-up period

P_D = Watts required to melt or vaporize load material during working cycle

P_L = Watts lost from surfaces by:

- Conduction-use equation to the right
- Radiation-use heat loss curves on pages 529 and 531, Reference 1, 2, 5, 6 and 7.
- Convection-use heat loss curves on pages 529 and 531, Reference 1, 2, 5, 6 and 7.

S.F. = Safety Factor is normally 10 to 35 percent based on application

*: 3.412 is a conversion factor: 3.412 BTU = 1 Wh

Equation for P_A and P_B (Absorbed watts-raising temperature)

$$P_A \text{ or } P_B = \frac{w \times C_p \times \Delta T}{(t \times 3.412)}$$

- w = weight of material (lb)
- C_p = specific heat of material (BTU/(lb•°F))
- ΔT = temperature rise of material ($T_{\text{Final}} - T_{\text{Initial}}$) (°F)
- t = start-up or cycle time (hr)

Equation for C and D (Absorbed watts-melting or vaporizing)

$$P_C \text{ or } P_D = \frac{w \times H_f}{(t \times 3.412)}$$

- w = weight of material (lb)
- H_f = Heat of fusion or vaporization (BTU/lb)
- t = start-up or cycle time (hr)

Equation for L (Lost conducted watts)

$$P_L = \frac{k \times A \times \Delta T}{(d \times 3.412)}$$

- k = thermal conductivity (BTU • in./((ft²•°F •hr))
- A = surface area (ft²)
- ΔT = temperature differential to ambient (°F)
- d = thickness of material (in.)



Power Calculations

Conduction and Convection Heating

Absorbed Energy, Heat Required to Raise the Temperature of a Material

Because substances all heat differently, different amounts of heat are required in making a temperature change. The specific heat capacity of a substance is the quantity of heat needed to raise the temperature of a unit quantity of the substance by one degree. Calling the amount of heat added **Q**, which will cause a change in temperature ΔT to a weight of substance **w**, at a specific heat of material **C_p**, then $Q = w \times C_p \times \Delta T$.

Since all calculations are in watts, an additional conversion of 3.412 BTU = 1 Wh is introduced yielding:

Equation 1

$$Q_A \text{ or } Q_B = \frac{w \times C_p \times \Delta T}{3.412}$$

Q_A = heat required to raise temperature of materials during heat-up (Wh)

Q_B = heat required to raise temperature of materials processed in working cycle (Wh)

w = weight of material (lb)

C_p = specific heat of material (BTU/(lb•°F))

ΔT = temperature rise of material ($T_{\text{Final}} - T_{\text{Initial}}$)(°F)

This equation should be applied to all materials absorbing heat in the application. Heated media, work being processed, vessels, racks, belts and ventilation air should be included.

Example: How much heat energy is needed to change the temperature of 50 lbs of copper from 10 to 70°F?

$$\begin{aligned} Q &= \frac{w \times C_p \times \Delta T}{3.412} \\ &= \frac{(50 \text{ lb}) \times (0.10 \text{ BTU}/[\text{lb}\cdot^\circ\text{F}]) \times (60^\circ\text{F})}{3.412} = 88 \text{ (Wh)} \end{aligned}$$

Heat Required to Melt or Vaporize a Material

In considering adding heat to a substance, it is also necessary to anticipate changes in state that might occur during this heating such as melting and vaporizing. The heat needed to melt a material is known as the latent heat of fusion and represented by **H_f**. Another state change is involved in vaporization and condensation. The latent heat of vaporization **H_v** of the substance is the energy required to change a substance from a liquid to a vapor. This same amount of energy is released as the vapor condenses back to a liquid.

Equation 2

$$Q_C \text{ or } Q_D = \frac{w \times H_f}{3.412} \quad \text{OR} \quad \frac{w \times H_v}{3.412}$$

Q_C = heat required to melt/vaporize materials during heat-up (Wh)

Q_D = heat required to melt/vaporize materials processed in working cycle (Wh)

w = weight of material (lb)

H_f = latent heat of fusion (BTU/lb)

H_v = latent heat of vaporization (BTU/lb)

Example: How much energy is required to melt 50 lbs of lead?

$$\begin{aligned} Q &= \frac{w \times H_f}{3.412} \\ &= \frac{(50 \text{ lbs}) \times (9.8 \text{ BTU}/\text{lb})}{3.412 \text{ BTU}/(\text{Wh})} = 144 \text{ (Wh)} \end{aligned}$$

Changing state (melting and vaporizing) is a constant temperature process. The **C_p** value (from Equation 1) of a material also changes with a change in state. Separate calculations are thus required using Equation 1 for the material below and above the phase change temperature.



Power Calculations

Conduction and Convection Heating (Continued)

Conduction Heat Losses

Heat transfer by conduction is the contact exchange of heat from one body at a higher temperature to another body at a lower temperature, or between portions of the same body at different temperatures.

Equation 3A—Heat Required to Replace Conduction Losses

$$Q_{L1} = \frac{k \times A \times \Delta T \times t_e}{3.412 \times L}$$

Q_{L1} = conduction heat losses (Wh)

k = thermal conductivity
(BTU x in./[ft² x °F x hour])

A = heat transfer surface area (ft²)

L = thickness of material (in.)

ΔT = temperature difference across material
($T_2 - T_1$) (°F)

t_e = exposure time (hr)

This expression can be used to calculate losses through insulated walls of containers or other plane surfaces where the temperature of both surfaces can be determined or estimated.

Convection Heat Losses

Convection is a special case of conduction. Convection is defined as the transfer of heat from a high temperature region in a gas or liquid as a result of movement of the masses of the fluid.

Equation 3B—Convection Losses

$$Q_{L2} = A \times F_{SL} \times C_F \times t_e$$

Q_{L2} = convection heat losses (Wh)

A = surface area (in²)

F_{SL} = vertical surface convection loss factor
(W/in²) evaluated at surface temperature (see page 529, Reference 1).

C_F = surface orientation factor
heated surface faces up horizontally = 1.29
vertical = 1.00
heated surface faces down horizontally = 0.63

Radiation Heat Losses

Radiation losses are not dependent on orientation of the surface. Emissivity is used to adjust for a material's ability to radiate heat energy.

Equation 3C—Radiation Losses

$$Q_{L3} = A \times F_{SL} \times e \times t_e$$

Q_{L3} = radiation heat losses (Wh)

A = surface area (in²)

F_{SL} = blackbody radiation loss factor at surface temperature (W/in²) (see page 529, Reference 1).

e = emissivity of material surface

Example:

We find that a blackbody radiator (perfect radiator) at 500°F, has heat losses of 2.95 W/in². Polished aluminum, in contrast, ($e = 0.09$) only has heat losses of 0.27 W/in² at the same temperature ($2.95 \text{ W/in}^2 \cdot 0.09 = 0.27 \text{ W/in}^2$).

Combined Convection and Radiation Heat Losses

Some curves combine both radiation and convection losses. This saves you from having to use both Equations 3B and 3C. If only the convection component is required, then the radiation component must be determined separately and subtracted from the combined curve.

Equation 3D—Combined Convection and Radiation Heat Losses

$$Q_{L4} = A \times F_{SL} \times t_e$$

Q_{L4} = surface heat losses combined convection and radiation (Wh)

A = surface area (in²)

F_{SL} = combined surface loss factor at surface temperature (W/in²) (see pages 529 and 531, Reference 1, 2, 5, 6 and 7).

This equation assumes a constant surface temperature.



Power Calculations

Conduction and Convection Heating (Continued)

Total Heat Losses

The total conduction, convection and radiation heat losses are summed together to allow for all losses in the power equations. Depending on the application, heat losses may make up only a small fraction of total power required or it may be the largest portion of the total. Therefore, do not ignore heat losses unless previous experience tells you it is alright to do.

Equation 3E—Total Losses

$Q_L = Q_{L1} + Q_{L2} + Q_{L3}$ If convection and radiation losses are calculated separately. (Surfaces are not uniformly insulated and losses must be calculated separately.)

OR

$Q_L = Q_{L1} + Q_{L4}$ If combined radiation and convection curves are used. (Pipes, ducts, uniformly insulated bodies.)

Start-Up and Operating Power Required

Both of these equations estimate required energy and convert it to power. Since power (watts) specifies an energy rate, we can use power to select electric heater requirements. Both the start-up power and the operating power must be analyzed before heater selection can take place.

Equation 4—Start-Up Power (Watts)

$$P_s = \frac{Q_A + Q_C + \frac{2}{3}Q_L}{t_s} (1 + S.F.)$$

Q_A = heat absorbed by materials during heat-up (Wh)

Q_C = latent heat absorbed during heat-up (Wh)

Q_L = conduction, convection, radiation losses (Wh)

S.F. = safety factor

t_s = start-up (heat-up) time required (hr)

During start up of a system the losses are zero, and rise to 100 percent at process temperature. A good approximation of actual losses is obtained when heat losses (Q_L) are multiplied by $\frac{2}{3}$.

Equation 5—Operating Power (Watts)

$$P_C = \frac{Q_B + Q_D + Q_L}{t_c} (1 + S.F.)$$

Q_B = heat absorbed by processed materials in working cycle (Wh)

Q_D = latent heat absorbed by materials heated in working cycle (Wh)

Q_L = conduction, convection, radiation losses (Wh)

S.F. = safety factor

t_c = cycle time required (hr)



Power Calculations

Conduction and Convection Heating (Continued)

Radiant Heating

When the primary mode of heat transfer is radiation, we add a step after Equation 5.

Equation 6 is used to calculate the net radiant heat transfer between two bodies. We use this to calculate either the radiant heater temperature required or (if we know the heater temperature, but not the power required) the maximum power which can be transferred to the load.

Equation 6—Radiation Heat Transfer

Between Infinite Size Parallel Surfaces

$$\frac{P_R}{A} = \frac{\sigma (T_1^4 - T_2^4) \left(\frac{1}{e_f}\right) F}{(144 \text{ in}^2/\text{ft}^2) (3.412 \text{ BTU/Wh})}$$

- P_R = power absorbed by the load (w) - from equation 4 or 5
- A = area of heater (in²) - known or assumed
- σ = Stephan Boltzman constant
= $0.1714 \cdot 10^{-8}$ (BTU/hr. sq. ft. °R⁴)
- T_1 (°R) = emitter temperature (°F + 460)
- T_2 (°R) = load temperature (°F + 460)
- e_f = emissivity correction factor - see Emissivity Correction Factor information to the right
- F = shape factor (0 to 1.0) - see Shape Factor for Radiant Application graph to the right

Emissivity Correction Factor (e_f)

$$e_f = \frac{1}{e_S} + \frac{1}{e_L} - 1 \quad \text{plane surfaces}$$

$$e_f = \frac{1}{e_S} + \frac{D_S}{D_L} \left(\frac{1}{e_L} - 1\right) \quad \text{concentric cylinders inner radiating outward}$$

$$e_f = \frac{1}{e_S} + \left(\frac{D_S}{D_L} \times \frac{1}{e_L}\right) - 1 \quad \text{concentric cylinders outer radiating inward}$$

- e_S = heater emissivity (from material emissivity tables)
- e_L = load emissivity (from material emissivity tables)
- D_S = heater diameter
- D_L = load diameter

Shape Factor for Radiant Application

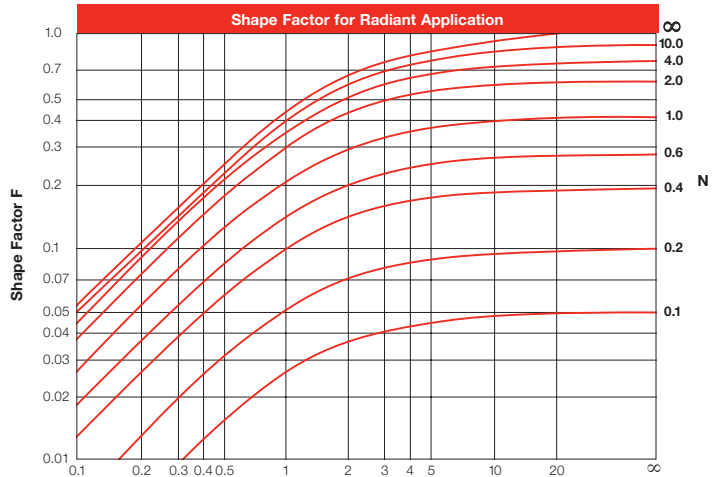

For Two Facing Panels:

$$N = \frac{\text{Heated Length}}{\left(\text{Distance to Material}\right)}$$

$$M = \frac{\text{Heated Width}}{\left(\text{Distance to Material}\right)}$$



Power Calculations

Conduction and Convection Heating (Continued)

Power Evaluation

After calculating the start up and operating power requirements, a comparison must be made and various options evaluated.

Shown in the graph below are the start up and operating watts displayed in a graphic format to help you see how power requirements add up.

With this graphic aid in mind, the following evaluations are possible:

- Compare start up watts to operating watts.
- Evaluate effects of lengthening start-up time such that start-up watts equals operating watts (use timer to start system before shift).

- Recognize that more heating capacity exists than is being utilized. (A short start-up time requirement needs more wattage than the process in wattage.)
- Identify where most energy is going and redesign or add insulation to reduce wattage requirements.

Having considered the entire system, a reevaluation of start-up time, production capacity and insulating methods should be made.

Comparison of Start Up and Operating Power Requirements

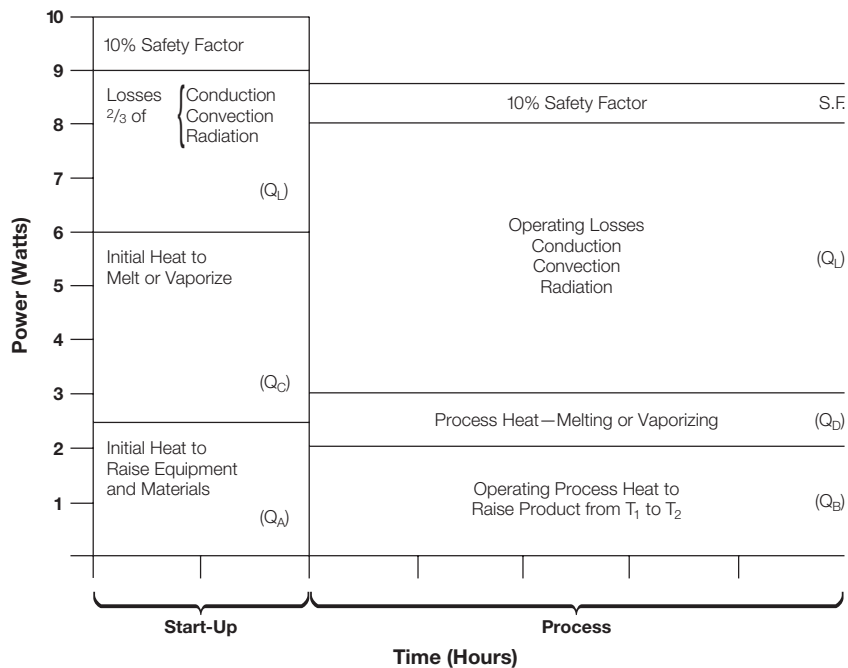



Power Calculations

Heat Loss Curves

Ref. 1—Convection curve correction factors:

For losses from top surfaces or from horizontal pipes Multiply convection curve by 1.29

For side surfaces and vertical pipes Use convection curve directly

For bottom surfaces Multiply convection curve value by 0.63

Radiation Curve Correction Factors

The radiation curve shows losses from a perfect blackbody and are not dependent upon position. Commonly used block materials lose less heat by radiation than a blackbody, so correction factors are applied. These corrections are the emissivity (e) values listed on page 530.

Ref. 1

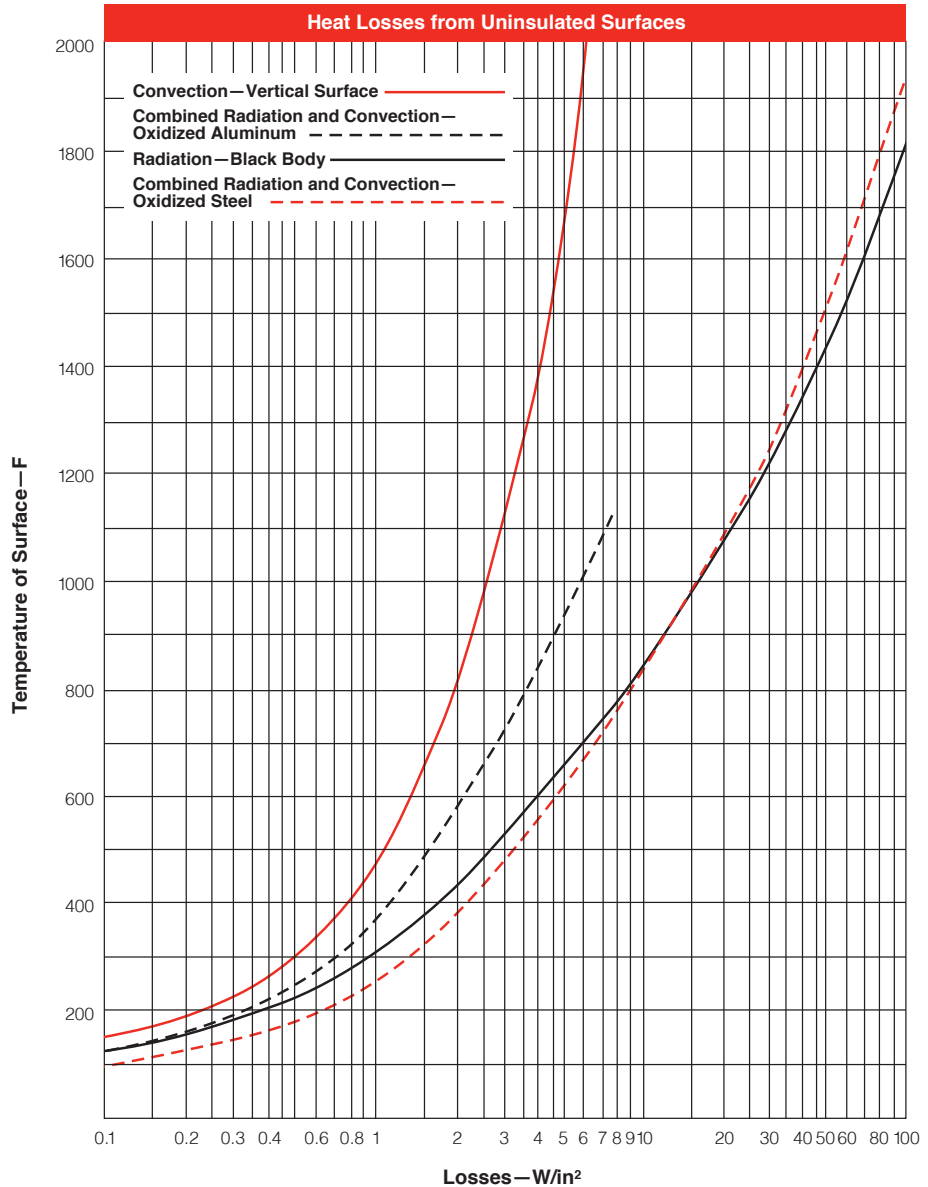

Ref. 2

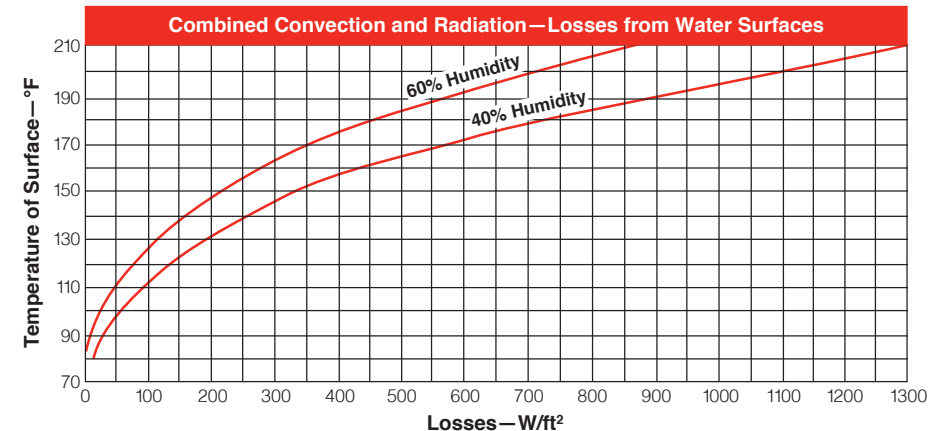

Reference Data (Imperial Unit)



Power Calculations

Heat Loss Curves

Some Material Emissivities/Metals - Ref. 3

Material	Specific Heat Btu/lb - °F	Emissivity		
		Polished Surface	Medium Oxide	Heavy Oxide
Blackbody			0.75	1.00
Aluminum	0.24	0.09	0.11	0.22
Brass	0.10	0.04	0.35	0.60
Copper	0.10	0.04	0.03	0.65
Incoloy® 800	0.12	0.20	0.60	0.92
Inconel® 600	0.11	0.20	0.60	0.92
Iron, Cast	0.12	—	0.80	0.85
Lead, solid	0.03	—	0.28	—
Magnesium	0.23	—	—	—
Nickel 200	0.11	—	—	—
Nichrome, 80-20	0.11	—	—	—
Solder, 50-50	0.04	—	—	—
Steel				
mild	0.12	0.10	0.75	0.85
stainless 304	0.11	0.17	0.57	0.85
stainless 430	0.11	0.17	0.57	0.85
Tin	0.056	—	—	—
Zinc	0.10	—	0.25	—

Some Material Emissivities/Non-Metals - Ref. 4

Material	Specific Heat Btu/lb - °F	Emissivity
Asbestos	0.25	Most non-metals: 0.90
Asphalt	0.40	
Brickwork	0.22	
Carbon	0.20	
Glass	0.20	
Paper	0.45	
Plastic	0.2-0.5	
Rubber	0.40	
Silicone Carbide	0.20-0.23	
Textiles	—	
Wood, Oak	0.57	

Reference Data (Imperial Unit)



Power Calculations

Heat Loss Curves

1. Based upon combined natural convection and radiation losses into 70°F environment.
2. Insulation characteristics
 $k = 0.67$ @ 200°F
 $k = 0.83$ @ 1000°F
3. For molded ceramic fiber products and packed or tightly packed insulation, losses will be lower than values shown.
 For 2 or 3 inches insulation multiply by 0.84.
 For 4 or 5 inches insulation multiply by 0.81.
 For 6 inches insulation multiply by 0.79.

Ref. 5

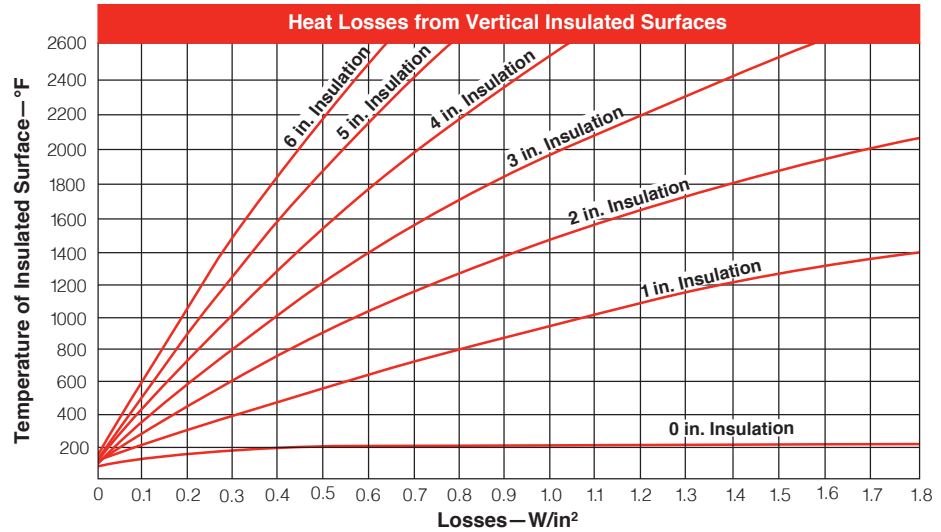

Ref. 6

*For losses of molten metal surfaces, use the curve $e=0.40$.

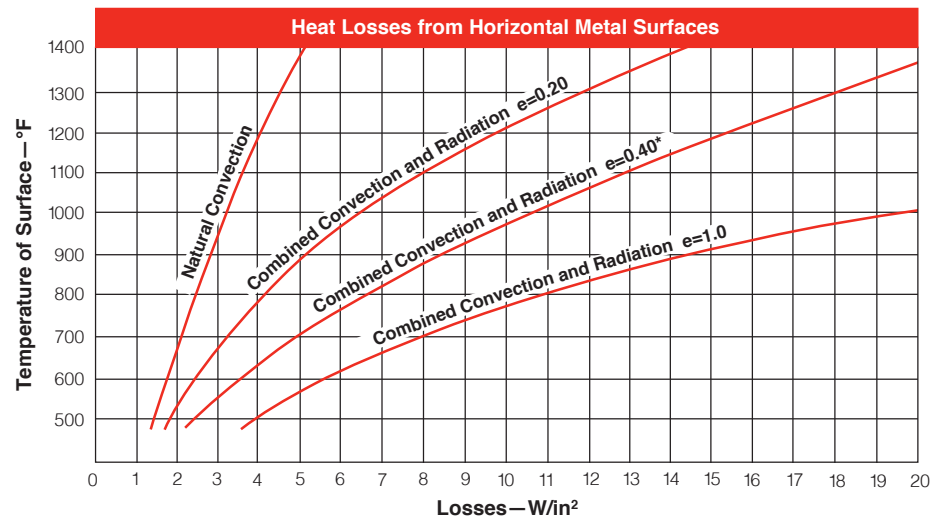

Ref. 7

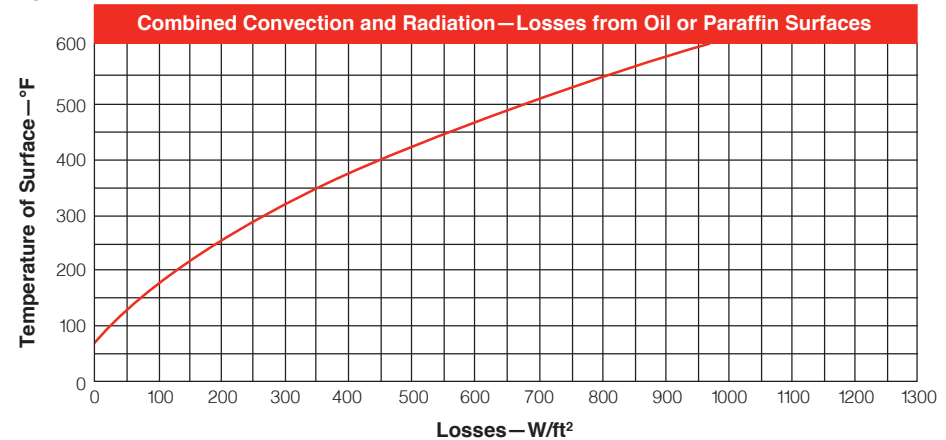

Reference Data (Imperial Unit)



Equations

Ohms Law

Volts

$$\text{Volts} = \sqrt{\text{Watts} \times \text{Ohms}}$$

$$\text{Volts} = \frac{\text{Watts}}{\text{Amperes}}$$

$$\text{Volts} = \text{Amperes} \times \text{Ohms}$$

Ohms

$$\text{Ohms} = \frac{\text{Volts}}{\text{Amperes}}$$

$$\text{Ohms} = \frac{\text{Volts}^2}{\text{Watts}}$$

$$\text{Ohms} = \frac{\text{Watts}}{\text{Amperes}^2}$$

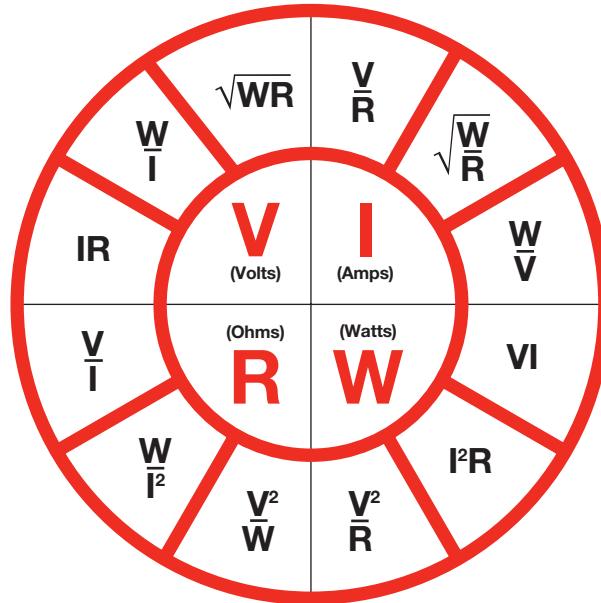

Amperes

$$\text{Amperes} = \frac{\text{Volts}}{\text{Ohms}}$$

$$\text{Amperes} = \frac{\text{Watts}}{\text{Volts}}$$

$$\text{Amperes} = \sqrt{\frac{\text{Watts}}{\text{Ohms}}}$$

Watts

$$\text{Watts} = \frac{\text{Volts}^2}{\text{Ohms}}$$

$$\text{Watts} = \text{Amperes}^2 \times \text{Ohms}$$

$$\text{Watts} = \text{Volts} \times \text{Amperes}$$

Wattage varies directly as ratio of voltages squared

$$W_2 = W_1 \times \left(\frac{V_2}{V_1} \right)^2$$

$$3 \text{ Phase Amperes} = \frac{\text{Total Watts}}{\text{Volts} \times 1.732}$$



Equations

Typical 3-Phase Wiring Diagrams and Equations for Resistive Heaters

Definitions

For Both Wye and Delta (Balanced Loads)

V_p = Phase voltage

V_L = Line voltage

I_p = Phase current

I_L = Line current

$R = R_1 = R_2 = R_3 =$
Resistance of each branch

W = Wattage

Wye and Delta Equivalents

$$W_{\text{DELTA}} = 3 W_{\text{WYE}}$$

$$W_{\text{ODELTA}} = \frac{2}{3} W_{\text{DELTA}}$$

$$W_{\text{OWYE}} = \frac{1}{2} W_{\text{WYE}}$$

3-Phase Delta (Balanced Load)

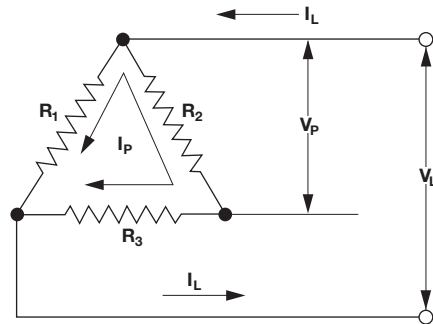

Equations For Delta Only

$$I_p = I_L / 1.73$$

$$V_p = V_L$$

$$W_{\text{DELTA}} = 3(V_L^2)/R$$

$$W_{\text{DELTA}} = 1.73 V_L I_L$$

3-Phase Wye (Balanced Load)

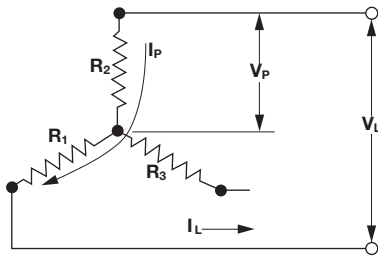

Equations For Wye Only

$$I_p = I_L$$

$$V_p = V_L / 1.73$$

$$W_{\text{WYE}} = V_L^2 / R = 3(V_p^2) / R$$

$$W_{\text{WYE}} = 1.73 V_L I_L$$

3-Phase Open Delta

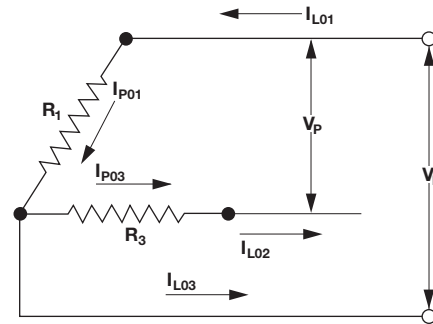

Equations For Open Delta Only

$$V_p = V_L$$

$$I_{p01} = I_{p03} = I_{L02}$$

$$I_{L03} = 1.73 I_{p01}$$

$$W_{\text{ODELTA}} = 2(V_L^2 / R)$$

3-Phase Open Wye (No Neutral)

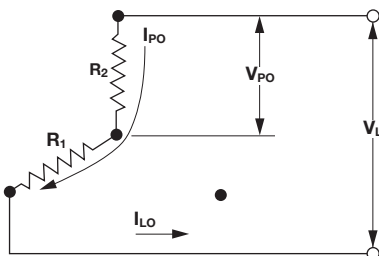

Equations For Open Wye Only

$$I_{p0} = I_{L0}$$

$$V_{p0} = V_L / 2$$

$$W_{\text{OWYE}} = \frac{1}{2} (V_L^2 / R)$$

$$W_{\text{OWYE}} = 2 (V_{p0}^2 / R)$$

$$W_{\text{OWYE}} = V_L I_{L0}$$



Wattage Requirements

The following equations can be used to make quick estimates of wattage requirements.

For Steel

Use equation:

$$\text{kW} = \frac{\text{pounds} \times \text{temperature rise } (^\circ\text{F})}{20,000 \times \text{heat-up time (hrs.)}}$$

1 cu. ft. = 7.49 gallons

For Heating Water in Tanks

Use equation:

$$\text{kW} = \frac{\text{gallons} \times \text{temperature rise } (^\circ\text{F})}{375 \times \text{heat-up time (hrs.)}}$$

1 cu. ft. = 7.49 gallons

For Air

Use equation:

$$\text{kW} = \frac{\text{CFM}^{**\textcircled{1}} \times \text{temperature rise } (^\circ\text{F})}{3000}$$

* Gallons per minute

** Cubic feet per minute

^① Measured at normal temperature and pressure

^② Measured at heater system inlet temperature and pressure

For Oil

Use equation:

$$\text{kW} = \frac{\text{gallons} \times \text{temperature rise } (^\circ\text{F})}{800 \times \text{heat-up time (hrs.)}}$$

For Heating Flowing Water

Use equation:

$$\text{kW} = \text{GPM}^* \times \text{temperature rise } (^\circ\text{F}) \times 0.16$$

For Compressed Air

Use equation:

$$\text{kW} = \frac{\text{CFM}^{**\textcircled{2}} \times \text{density}^{\textcircled{2}} \times \text{temperature rise } (^\circ\text{F})}{228}$$

Reference Data (Imperial Unit)



Wattage Requirements

Kilowatt-Hours to Superheat Steam

1. Plot points on lines **P**, **Q** and **S**. **P** represents the inlet temperature (and saturation pressure) of the system.
Q represents the liquid content of the water vapor.
S indicates the outlet temperature minus the saturated temperature.
W indicates the heat content of the water vapor.
 2. Draw a straight line from **P** through **Q** to **W**. Read W_1 .
 3. Draw a straight line from **P** through **S** to **W**. Read W_2 .
 4. Required watts = Weight (lbs) of steam/hour x $(W_2 - W_1)$
- Watt density is critical. Review temperature and velocity prior to heater selection.

Example Shown:

Q = 90% quality (% R.H.)
P = 75 psig
S = 320°F

Superheat Steam

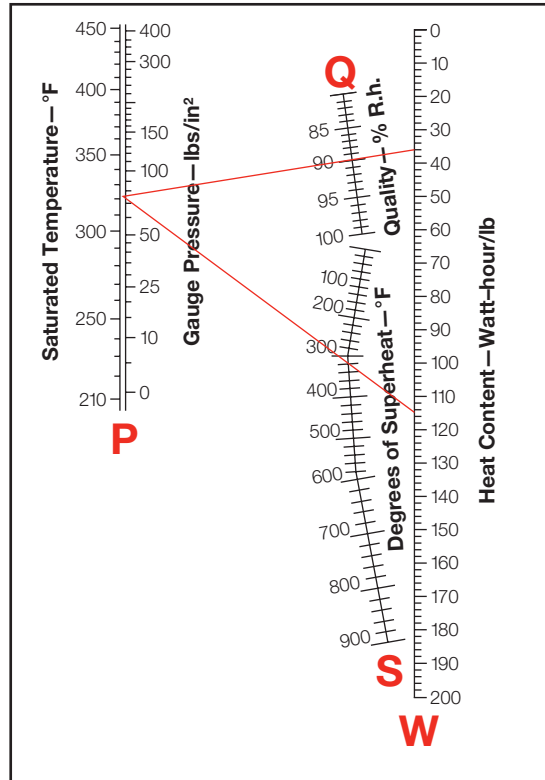

Note: Reference is based on >80% steam quality at >20 psig.



Power Calculations

Calculations for Required Heat Energy

The total heat energy (kWh or BTU) required to satisfy the system needs will be either of the two values shown below depending on which calculated result is larger.

1. Heat required for start up
2. Heat required to maintain the desired temperature

The power required (kW) will be the heat energy value (kWh) divided by the required start up or working cycle time. The kW rating of the heater will be the greater of these values plus a safety factor.

The calculation of start-up and operating requirements consist of several distinct parts that are best handled separately. However, a short method can also be used for a quick estimate of heat energy required. Both methods are defined and then evaluated using the following formulas and methods:

Short Method

Start-up watts = $(P_A + P_C + \frac{2}{3} P_L) \times (1 + S.F.)$

Operating watts = $(P_B + P_D + P_L) \times (1 + S.F.)$

P_A = Watts required to raise the temperature of material and equipment to the operating point, within the time desired

P_B = Watts required to maintain temperature of the material during the working cycle

P_C = Watts required to melt or vaporize load material during start-up period

P_D = Watts required to melt or vaporize load material during working cycle

P_L = Watts lost from surfaces by:

- Conduction-use equation to the right
- Radiation-use heat loss curves on pages 542 and 543, Reference 1, 2, 5, 6 and 7.
- Convection-use heat loss curves on pages 542 and 543, Reference 1, 2, 5, 6 and 7.

S.F. = Safety Factor is normally 10 to 35 percent based on application

Equation for P_A and P_B (Absorbed watts-raising temperature)

$$P_A \text{ or } P_B = \frac{(w \times C_p \times \Delta T)}{t}$$

- w = weight of material (kg)
- C_p = specific heat of material (J/(kg•°C))
- ΔT = temperature rise of material ($T_{\text{Final}} - T_{\text{Initial}}$) (°C)
- t = start-up or cycle time (s)

Equation for C and D (Absorbed watts-melting or vaporizing)

$$P_C \text{ or } P_D = \frac{w \times H_f}{t}$$

- w = weight of material (kg)
- H_f = Heat of fusion or vaporization (J/kg)
- t = start-up or cycle time (s)

Equation for L (Lost conducted watts)

$$P_L = \frac{k \times A \times \Delta T}{d}$$

- k = thermal conductivity (W/m °C)
- A = surface area (m²)
- ΔT = temperature differential to ambient (°C)
- d = thickness of material (m)



Power Calculations

Conduction and Convection Heating

Absorbed Energy, Heat Required to Raise the Temperature of a Material

Because substances all heat differently, different amounts of heat are required in making a temperature change. The specific heat capacity of a substance is the quantity of heat needed to raise the temperature of a unit quantity of the substance by one degree. Calling the amount of heat added **Q**, which will cause a change in temperature ΔT to a weight of substance **w**, at a specific heat of material **C_p**, then $Q = w \times C_p \times \Delta T$.

Since all calculations are in watts, an additional conversion of 3600 Ws (J) = 1 Wh is introduced yielding:

Equation 1

$$Q_A \text{ or } Q_B = \frac{w \times C_p \times \Delta T}{3600}$$

Q_A = heat required to raise temperature of materials during heat-up (Wh)

Q_B = heat required to raise temperature of materials processed in working cycle (Wh)

w = weight of material (kg)

C_p = specific heat of material (J/(kg•°C))

ΔT = temperature rise of material ($T_{Final} - T_{Initial}$)(°C)

This equation should be applied to all materials absorbing heat in the application. Heated media, work being processed, vessels, racks, belts and ventilation air should be included.

Example: How much heat energy is needed to change the temperature of 25 kg of copper from 25 to 60°C?

$$\begin{aligned} Q &= \frac{w \times C_p \times \Delta T}{3600} \\ &= \frac{(25 \text{ kg}) \times (385 \text{ J}/[\text{kg}\cdot\text{°C}]) \times (35\text{°C})}{3600} = 94 \text{ (Wh)} \end{aligned}$$

Heat Required to Melt or Vaporize a Material

In considering adding heat to a substance, it is also necessary to anticipate changes in state that might occur during this heating such as melting and vaporizing. The heat needed to melt a material is known as the latent heat of fusion and represented by **H_f**. Another state change is involved in vaporization and condensation. The latent heat of vaporization **H_v** of the substance is the energy required to change a substance from a liquid to a vapor. This same amount of energy is released as the vapor condenses back to a liquid.

Equation 2

$$Q_C \text{ or } Q_D = \frac{w \times H_f}{3600} \quad \text{OR} \quad \frac{w \times H_v}{3600}$$

Q_C = heat required to melt/vaporize materials during heat-up (Wh)

Q_D = heat required to melt/vaporize materials processed in working cycle (Wh)

w = weight of material (kg)

H_f = latent heat of fusion (J/kg)

H_v = latent heat of vaporization (J/kg)

Example: How much energy is required to melt 25 kg of lead?

$$\begin{aligned} Q &= \frac{w \times H_f}{3600} \\ &= \frac{(25 \text{ kg}) \times (22800 \text{ J}/\text{kg})}{3600} = 158 \text{ (Wh)} \end{aligned}$$

Changing state (melting and vaporizing) is a constant temperature process. The **C_p** value (from Equation 1) of a material also changes with a change in state. Separate calculations are thus required using Equation 1 for the material below and above the phase change temperature.



Power Calculations

Conduction and Convection Heating (Continued)

Conduction Heat Losses

Heat transfer by conduction is the contact exchange of heat from one body at a higher temperature to another body at a lower temperature, or between portions of the same body at different temperatures.

Equation 3A—Heat Required to Replace Conduction Losses

$$Q_{L1} = \frac{k \times A \times \Delta T \times t_e}{L}$$

Q_{L1} = conduction heat losses (Wh)

k = thermal conductivity (W/(m•°C))

A = heat transfer surface area (m²)

L = thickness of material (m)

ΔT = temperature difference across material (T₂-T₁) (°C)

t_e = exposure time (hr)

This expression can be used to calculate losses through insulated walls of containers or other plane surfaces where the temperature of both surfaces can be determined or estimated.

Convection Heat Losses

Convection is a special case of conduction. Convection is defined as the transfer of heat from a high temperature region in a gas or liquid as a result of movement of the masses of the fluid.

Equation 3B—Convection Losses

$$Q_{L2} = A \times F_{SL} \times C_F \times t_e$$

Q_{L2} = convection heat losses (Wh)

A = surface area (m²)

F_{SL} = vertical surface convection loss factor (W/m²) evaluated at surface temperature (see page 542, Reference 1.)

C_F = surface orientation factor
 heated surface faces up horizontally = 1.29
 vertical = 1.00
 heated surface faces down horizontally = 0.63

Radiation Heat Losses

Radiation losses are not dependent on orientation of the surface. Emissivity is used to adjust for a material's ability to radiate heat energy.

Equation 3C—Radiation Losses

$$Q_{L3} = A \times F_{SL} \times e \times t_e$$

Q_{L3} = radiation heat losses (Wh)

A = surface area (m²)

F_{SL} = blackbody radiation loss factor at surface temperature (W/m²) (see page 542, Reference 1.)

e = emissivity of material surface

Example:

We find that a blackbody radiator (perfect radiator) at 260°C, has heat losses of 4851 W/m². Polished aluminum, in contrast, ($e = 0.09$) only has heat losses of 412 W/m² at the same temperature (4851 W/m² · 0.09 = 412 W/m²).

Combined Convection and Radiation Heat Losses

Some curves combine both radiation and convection losses. This saves you from having to use both Equations 3B and 3C. If only the convection component is required, then the radiation component must be determined separately and subtracted from the combined curve.

Equation 3D—Combined Convection and Radiation Heat Losses

$$Q_{L4} = A \times F_{SL} \times t_e$$

Q_{L4} = surface heat losses combined convection and radiation (Wh)

A = surface area (m²)

F_{SL} = combined surface loss factor at surface temperature (W/m²) (see pages 542 and 543, Reference 1, 2, 5, 6 and 7.)

This equation assumes a constant surface temperature.



Power Calculations

Conduction and Convection Heating (Continued)

Total Heat Losses

The total conduction, convection and radiation heat losses are summed together to allow for all losses in the power equations. Depending on the application, heat losses may make up only a small fraction of total power required or it may be the largest portion of the total. Therefore, do not ignore heat losses unless previous experience tells you it is alright to do.

Equation 3E—Total Losses

$Q_L = Q_{L1} + Q_{L2} + Q_{L3}$ If convection and radiation losses are calculated separately. (Surfaces are not uniformly insulated and losses must be calculated separately.)

OR

$Q_L = Q_{L1} + Q_{L4}$ If combined radiation and convection curves are used. (Pipes, ducts, uniformly insulated bodies.)

Start-Up and Operating Power Required

Both of these equations estimate required energy and convert it to power. Since power (watts) specifies an energy rate, we can use power to select electric heater requirements. Both the start-up power and the operating power must be analyzed before heater selection can take place.

Equation 4—Start-Up Power (Watts)

$$P_s = \frac{Q_A + Q_C + \frac{2}{3}Q_L}{t_s} (1 + S.F.)$$

Q_A = heat absorbed by materials during heat-up (Wh)

Q_C = latent heat absorbed during heat-up (Wh)

Q_L = conduction, convection, radiation losses (Wh)

S.F. = safety factor

t_s = start-up (heat-up) time required (hr)

During start up of a system the losses are zero, and rise to 100 percent at process temperature. A good approximation of actual losses is obtained when heat losses (Q_L) are multiplied by $\frac{2}{3}$.

Equation 5—Operating Power (Watts)

$$P_C = \frac{Q_B + Q_D + Q_L}{t_c} (1 + S.F.)$$

Q_B = heat absorbed by processed materials in working cycle (Wh)

Q_D = latent heat absorbed by materials heated in working cycle (Wh)

Q_L = conduction, convection, radiation losses (Wh)

S.F. = safety factor

t_c = cycle time required (hr)



Power Calculations

Conduction and Convection Heating (Continued)

Radiant Heating

When the primary mode of heat transfer is radiation, we add a step after Equation 5.

Equation 6 is used to calculate the net radiant heat transfer between two bodies. We use this to calculate either the radiant heater temperature required or (if we know the heater temperature, but not the power required) the maximum power which can be transferred to the load.

Equation 6—Radiation Heat Transfer

Between Infinite Size Parallel Surfaces

$$\frac{P_R}{A} = \sigma (T_1^4 - T_2^4) \left(\frac{1}{e_f} \right) F$$

- P_R = power absorbed by the load (w) - from equation 4 or 5
- A = area of heater (m²) - known or assumed
- σ = Stephan Boltzman constant
= $5.67 \cdot 10^{-8}$ (W/m²•K⁴)
- T_1 (K) = emitter temperature (°C + 273.15)
- T_2 (K) = load temperature (°C + 273.15)
- e_f = emissivity correction factor - see Emissivity Correction Factor information to the right
- F = shape factor (0 to 1.0) - see Shape Factor for Radiant Application graph to the right

Emissivity Correction Factor (e_f)

$$e_f = \frac{1}{e_S} + \frac{1}{e_L} - 1 \quad \text{plane surfaces}$$

$$e_f = \frac{1}{e_S} + \frac{D_S}{D_L} \left(\frac{1}{e_L} - 1 \right) \quad \text{concentric cylinders inner radiating outward}$$

$$e_f = \frac{1}{e_S} + \left(\frac{D_S}{D_L} \times \frac{1}{e_L} \right) - 1 \quad \text{concentric cylinders outer radiating inward}$$

- e_S = heater emissivity (from material emissivity tables)
- e_L = load emissivity (from material emissivity tables)
- D_S = heater diameter
- D_L = load diameter

Shape Factor for Radiant Application

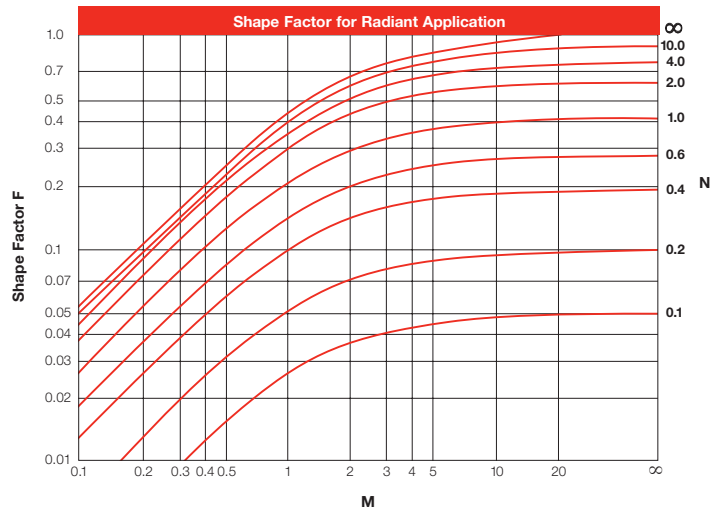

For Two Facing Panels:

$$N = \frac{\text{Heated Length}}{\left(\text{Distance to Material} \right)}$$

$$M = \frac{\text{Heated Width}}{\left(\text{Distance to Material} \right)}$$



Power Calculations

Conduction and Convection Heating (Continued)

Power Evaluation

After calculating the start up and operating power requirements, a comparison must be made and various options evaluated.

Shown in the graph below are the start up and operating watts displayed in a graphic format to help you see how power requirements add up.

With this graphic aid in mind, the following evaluations are possible:

- Compare start up watts to operating watts.
- Evaluate effects of lengthening start-up time such that start-up watts equals operating watts (use timer to start system before shift).

- Recognize that more heating capacity exists than is being utilized. (A short start-up time requirement needs more wattage than the process in wattage.)
- Identify where most energy is going and redesign or add insulation to reduce wattage requirements.

Having considered the entire system, a reevaluation of start-up time, production capacity and insulating methods should be made.

Comparison of Start Up and Operating Power Requirements

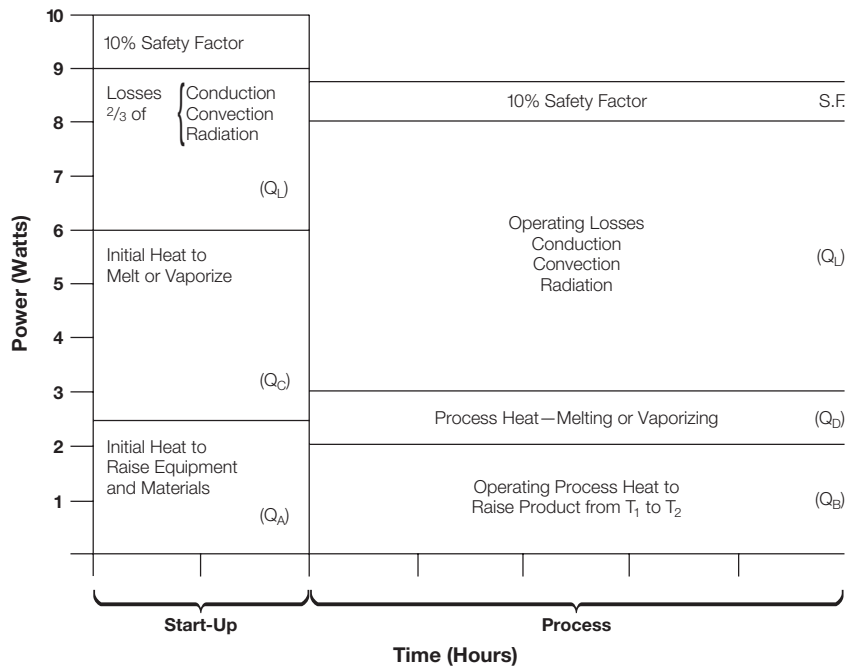



Power Calculations

Heat Loss Curves

Ref. 1—Convection curve correction factors:

For losses from top surfaces or from horizontal pipes Multiply convection curve by 1.29

For side surfaces and vertical pipes Use convection curve directly

For bottom surfaces Multiply convection curve value by 0.63

Radiation Curve Correction Factors

The radiation curve shows losses from a perfect blackbody and are not dependent upon position. Commonly used block materials lose less heat by radiation than a blackbody, so correction factors are applied. These corrections are the emissivity (ϵ) values listed in the reference data section on page 530.

Ref. 1

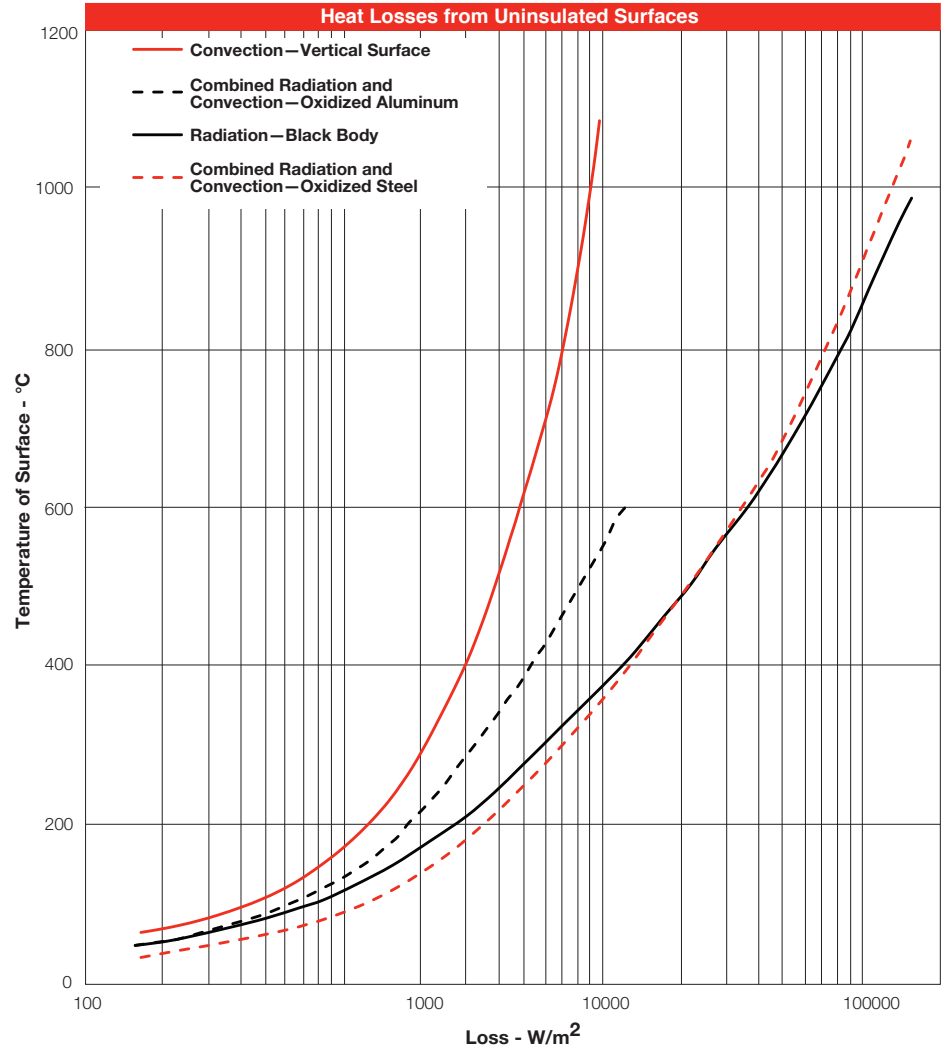

Ref. 2

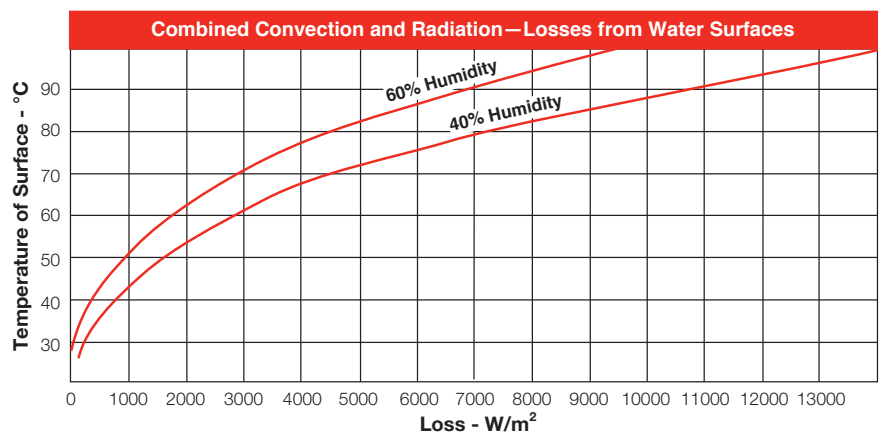



Power Calculations

Heat Loss Curves

Ref. 5

- Based upon combined natural convection and radiation losses into 21°C environment.
- Insulation characteristics
 $k = 0.097 \text{ W/m K @ } 93^\circ\text{C}$
 $k = 0.120 \text{ W/m K @ } 538^\circ\text{C}$
- For molded ceramic fiber products and packed or tightly packed insulation, losses will be lower than values shown.
 For 50.8 or 76.2 mm insulation multiply by 0.84.
 For 102 or 127 mm insulation multiply by 0.81.
 For 152 inches insulation multiply by 0.79.

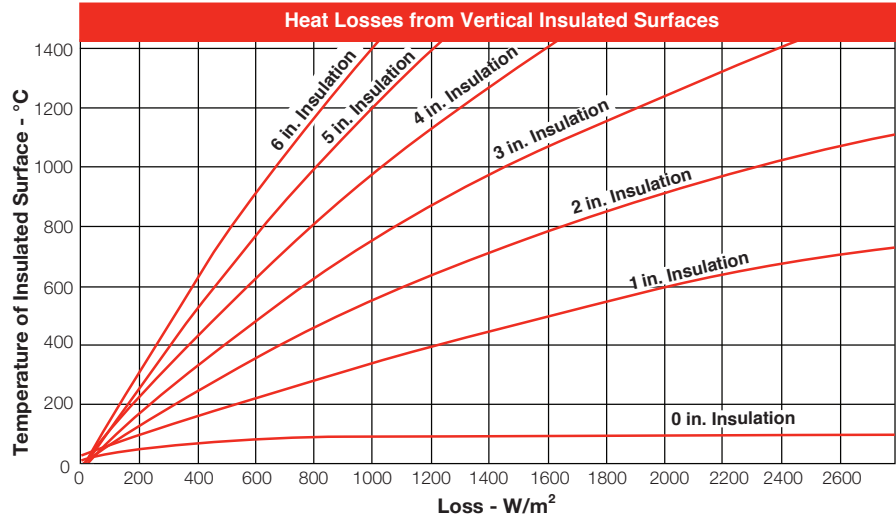

Ref. 6

*For losses of molten metal surfaces, use the curve $e=0.40$.

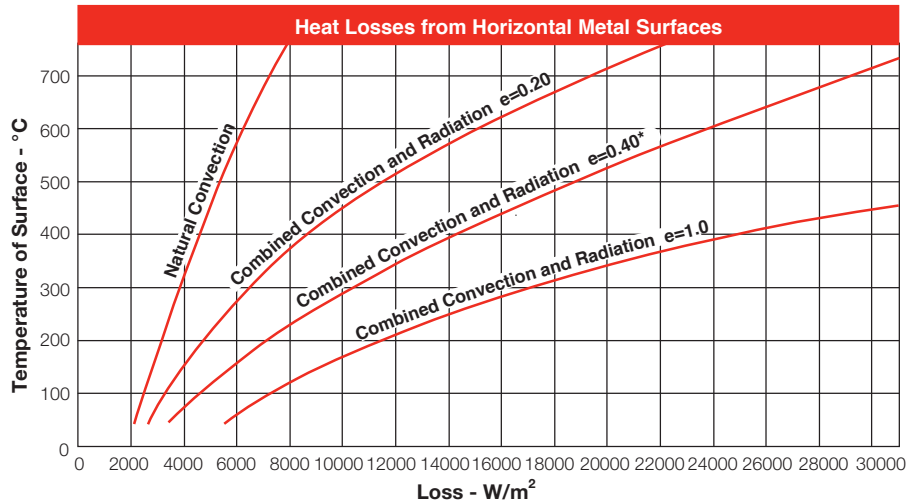

Ref. 7

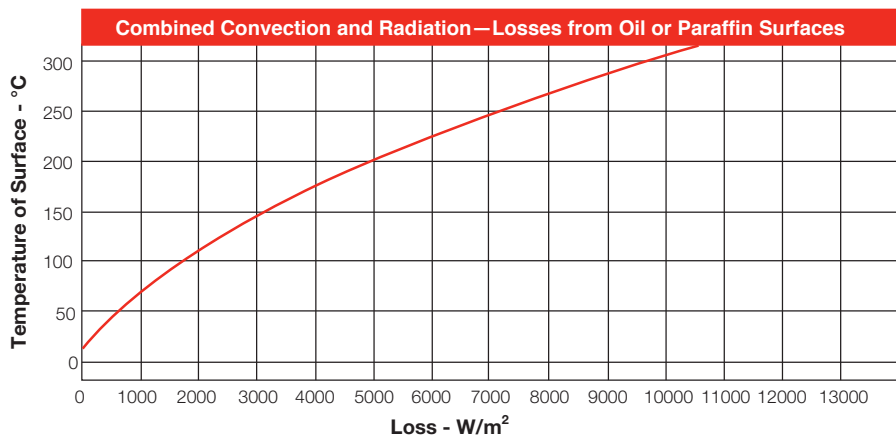



Equations

Ohm's Law

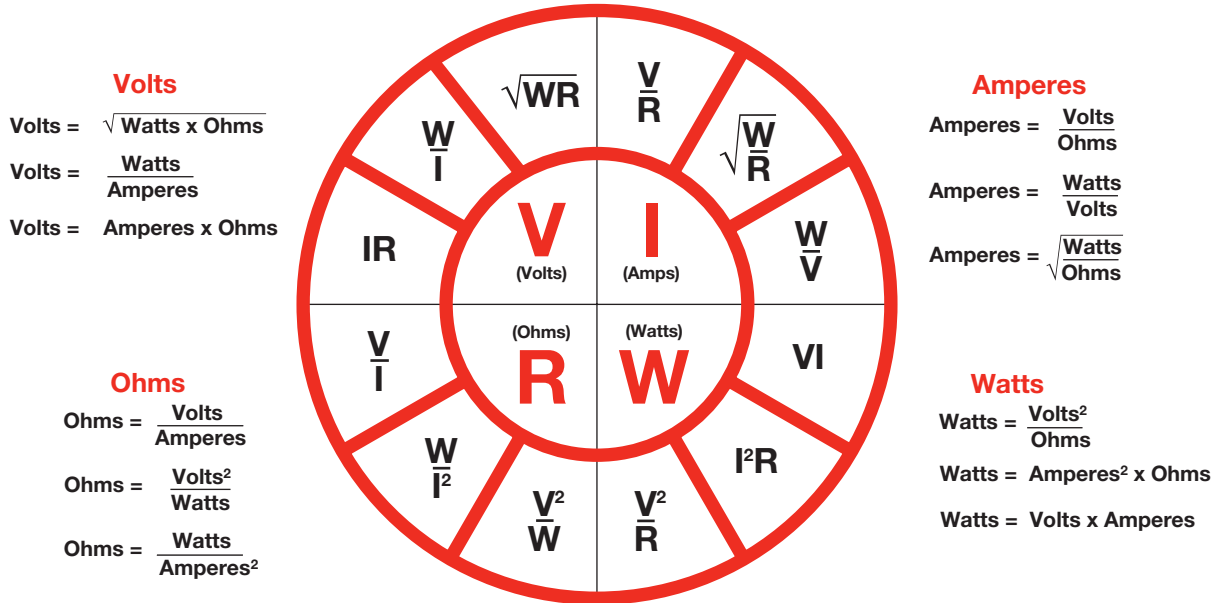

Wattage varies directly as ratio of voltages squared

$$W_2 = W_1 \times \left(\frac{V_2}{V_1}\right)^2$$

$$3 \text{ Phase Amperes} = \frac{\text{Total Watts}}{\text{Volts} \times 1.732}$$



Equations

Typical 3-Phase Wiring Diagrams and Equations for Resistive Heaters

Definitions

For Both Wye and Delta (Balanced Loads)

V_p = Phase voltage

V_L = Line voltage

I_p = Phase current

I_L = Line current

$R = R_1 = R_2 = R_3 =$
Resistance of each branch

W = Wattage

Wye and Delta Equivalents

$$W_{\text{DELTA}} = 3 W_{\text{WYE}}$$

$$W_{\text{ODELTA}} = \frac{2}{3} W_{\text{DELTA}}$$

$$W_{\text{OWYE}} = \frac{1}{2} W_{\text{WYE}}$$

3-Phase Delta (Balanced Load)

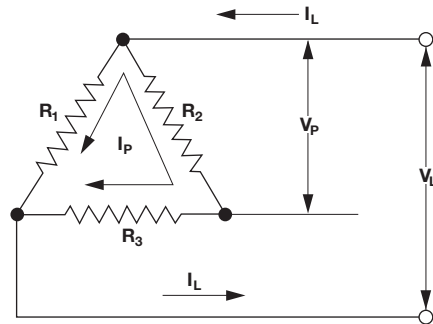

Equations For Delta Only

$$I_p = I_L / 1.73$$

$$V_p = V_L$$

$$W_{\text{DELTA}} = 3(V_L^2)/R$$

$$W_{\text{DELTA}} = 1.73 V_L I_L$$

3-Phase Wye (Balanced Load)

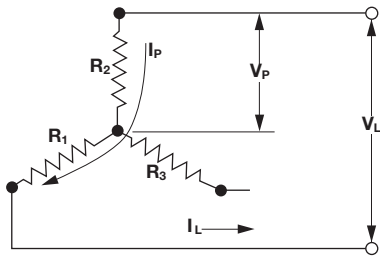

Equations For Wye Only

$$I_p = I_L$$

$$V_p = V_L / 1.73$$

$$W_{\text{WYE}} = V_L^2 / R = 3(V_p^2) / R$$

$$W_{\text{WYE}} = 1.73 V_L I_L$$

3-Phase Open Delta

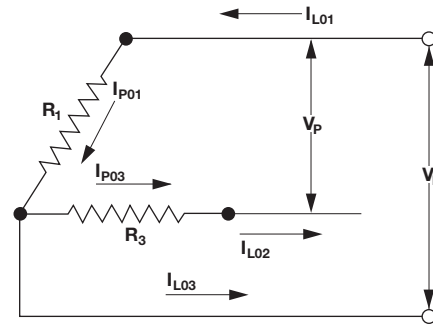

Equations For Open Delta Only

$$V_p = V_L$$

$$I_{p01} = I_{p03} = I_{L02}$$

$$I_{L03} = 1.73 I_{p01}$$

$$W_{\text{ODELTA}} = 2(V_L^2 / R)$$

3-Phase Open Wye (No Neutral)

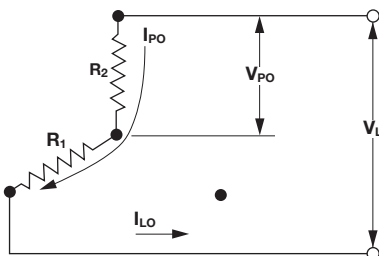

Equations For Open Wye Only

$$I_{p0} = I_{L0}$$

$$V_{p0} = V_L / 2$$

$$W_{\text{OWYE}} = \frac{1}{2} (V_L^2 / R)$$

$$W_{\text{OWYE}} = 2 (V_{p0}^2 / R)$$

$$W_{\text{OWYE}} = V_L I_{L0}$$



Wattage Requirements

The following equations can be used to make quick estimates of wattage requirements.

For Steel

Use equation:

$$\text{kW} = \frac{\text{kilograms} \times \text{temperature rise } (^{\circ}\text{C})}{5040 \times \text{heat-up time (hrs.)}}$$

For Oil

Use equation:

$$\text{kW} = \frac{\text{liters} \times \text{temperature rise } (^{\circ}\text{C})}{1680 \times \text{heat-up time (hrs.)}}$$

For Heating Water in Tanks

Use equation:

$$\text{kW} = \frac{\text{liters} \times \text{temperature rise } (^{\circ}\text{C})}{790 \times \text{heat-up time (hrs.)}}$$

For Heating Flowing Water

Use equation:

$$\text{kW} = \text{liters/min.} \times \text{temperature rise } (^{\circ}\text{C}) \times 0.076$$

For Air

Use equation:

$$\text{kW} = \frac{\text{cubic meters/min}^{\text{①}} \times \text{temperature rise } (^{\circ}\text{C})}{47}$$

For Compressed Air

Use equation:

$$\text{kW} = \frac{\text{cubic meters/min.}^{\text{②}} \times \text{temperature rise } (^{\circ}\text{C}) \times \text{density (kg/m}^3\text{)}^{\text{②}}}{57}$$

^① Measured at normal temperature and pressure

^② Measured at heater system inlet temperature and pressure



Wattage Requirements

Kilowatt-Hours to Superheat Steam

1. Plot points on lines **P**, **Q** and **S**. **P** represents the inlet temperature (and saturation pressure) of the system.
Q represents the liquid content of the water vapor.
S indicates the outlet temperature minus the saturated temperature.
W indicates the heat content of the water vapor.
 2. Draw a straight line from **P** through **Q** to **W**. Read W_1 .
 3. Draw a straight line from **P** through **S** to **W**. Read W_2 .
 4. Required watts = Weight (lbs) of steam/hour x $(W_2 - W_1)$
- Watt density is critical. Review temperature and velocity prior to heater selection.

Example Shown:

- Q = 90% quality (% R.H.)
 P = 75 psig
 S = 320°F

Superheat Steam

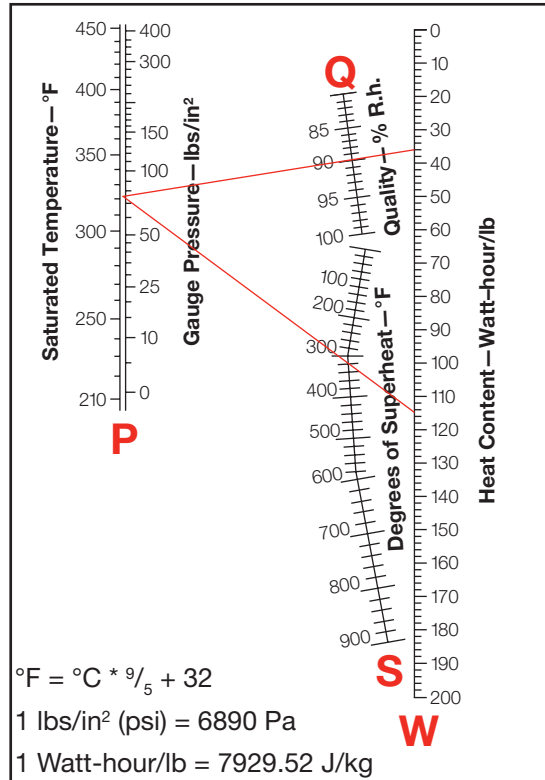

Note: Reference is based on >80% steam quality at >20 psig.



Tubular Elements and Assembly Selection Guide

Watlow® tubular elements and assemblies are primarily used for direct immersion in water, oils, viscous materials, solvents, process solutions and molten materials as well as air and gases.

Additionally, round and flat surface tubular elements (WATROD™ and FIREBAR® heaters respectively) can be used for surface heating.

WATROD and FIREBAR heating elements may be purchased separately, or fabricated into process heating assemblies, including:

- Screw plug
- Flange
- Circulation
- Booster
- Engine preheater
- Duct

Both elements and assemblies are available from stock. They can be configured with a variety of watt and volt ratings, terminations, sheath materials and mounting options to satisfy the most demanding applications.

If our stock products do not meet your application needs, Watlow can custom engineer the optimum heater.

Performance Capabilities

- Sheath temperatures up to 1800°F (983°C)
- Assembly wattages to 3 megawatts
- Process assembly ratings up to 3000psi
- Watt densities up to 120 W/in² (18.6 W/cm²)
- Enhanced performance beyond these specifications is available upon request
- Watlow can design thermal systems to meet specific performance criteria. Contact your local Watlow representative for assistance.

Features and Benefits

53 standard bend formations

- Enables designing of the heating element around available space to maximize heating efficiency



FIREBAR flat surface geometry

- Enhances heat transfer in both immersion and air applications and also surface heating
- Increases surface area per linear inch allowing heaters to run cooler in viscous materials

Wattages from 95 watts to 3 megawatts (on individual elements and assemblies respectively)

- Makes tubular heaters one of the most versatile electric heating sources available

Typical Applications

- Liquids
- Air
- Gases
- Molten materials
- Contact surface heating
- Radiant surface heating



Tubular Elements and Assembly Selection Guide

The following two charts will help you select an appropriate heater based on your application and watt density restrictions. These charts are application driven. The total wattage required by your application should be known before selecting a specific heater type(s) from the stock tables. If your required wattage is not known, please contact your Watlow representative.

Once the heater type has been identified, turn to the appropriate product section for information on the element or assembly.

Element and Assembly Selection Guide

To identify the tubular heater type best suited to your application, consult the *Element and Assembly Selection Guide*.

In most cases Watlow recommends using single tubular heating elements for low kilowatt applications.

Assemblies are better suited for large kilowatt applications to heat liquids, air or gases.

When selecting a heater according to watt density, be sure to consider the following:

- Liquid viscosity at start up and at process temperature
- Operating temperature
- Chemical composition

Under the “**Heating Method**” column in the *Element and Assembly Selection Guide* locate the method that applies to your application to find the recommended “Heater Type.”

After identifying the heater type(s) suitable for your application, refer to the *Supplemental Applications Chart* for further application data. This chart will assist you in selecting the appropriate watt density and sheath material for your specific application. It also presents the performance characteristics for both WATROD and FIREBAR elements.

Element and Assembly Selection Guide

Application	Heating Method	Heater Type
Liquids:		
Acids	Direct immersion (circulating/non-circulating)	FIREBAR, WATROD, screw plug, flange and pipe insert
Caustic soda 12% concentrate 10% concentrate 75% concentrate	Direct immersion (circulating/non-circulating)	WATROD, screw plug, square flange, flange, circulation and pipe insert
Degreasing solutions	Direct immersion (circulating/non-circulating)	FIREBAR, WATROD, screw plug, square flange, flange and pipe insert
Electroplating	Direct immersion (circulating/non-circulating)	FIREBAR, WATROD, screw plug, square flange, flange and pipe insert
Ethylene glycol 50% concentrate 100% concentrate	Direct immersion (circulating/non-circulating)	FIREBAR, WATROD, screw plug, flange, circulation, booster and engine preheater
Oils Asphalt Fuel oils Light grades 1 and 2 Medium grades 4 and 5 Heavy grade 6 and Bunker C Heat transfer Lubricating SAE 10, 20, 30 SAE 40, 50 API STD 614 Vegetable (cooking)	Direct immersion (circulating/non-circulating)	FIREBAR, WATROD, screw plug, square flange, flange, circulation, booster and pipe insert
Paraffin or wax	Direct immersion (circulating/non-circulating)	FIREBAR, WATROD, screw plug, square flange, flange, over-the-side, drum and pipe insert

CONTINUED



Tubular Elements and Assembly Selection Guide

Element and Assembly Selection Guide (Continued)

Application	Heating Method	Heater Type
Water Clean Deionized Demineralized Potable Process	Direct immersion (circulating/non-circulating)	FIREBAR (non-process water only) WATROD, screw plug, screw plug with control assembly, square flange, flange, circulation, booster, engine preheater and pipe insert
Air:	Direct (forced or natural convection)	FIREBAR, WATROD, FINBAR, WATROD enclosure heater, screw plug, flange, circulation and duct
Gas: Hydrocarbons, Nitrogen, Oxygen Ozone, Steam	Direct (forced convection)	FIREBAR, WATROD, screw plug, flange and circulation
Molten Materials: Aluminum Lead Salt Solder	Indirect (radiant) Direct (non-circulating) Direct (non-circulating) Direct (non-circulating)	WATROD FIREBAR and WATROD FIREBAR and WATROD FIREBAR and WATROD
Surface Heating: Dies, griddles, molds, platens	Direct	FIREBAR and WATROD

Supplemental Applications Chart

This *Supplemental Applications Chart* is provided in addition to the *Element and Assembly Selection Guide*. This chart will help you select watt density and sheath materials for either WATROD or FIREBAR heating elements according to the specific media being heated.

For example, if you are heating vegetable oil, either WATROD or FIREBAR elements at 30 and 40 W/in² respectively (4.6 and 6.2 W/cm²) with 304 stainless steel, sheath can be used.

Supplemental Applications Chart

Heated Material	Max. Operating Temperature °F (°C)		WATROD Element		FIREBAR Element		
			Max. Watt Density W/in ² (W/cm ²)	Sheath Material	Max. Watt Density W/in ² (W/cm ²)	Sheath Material	
Acid Solutions (Mild)							
Acetic	180	(82)	40 (6.2)	316 SS	40 (6.2)	Alloy 800	
Boric (30% max.)	257	(125)	40 (6.2)	Titanium	40 (6.2)	304 SS	
Carbonic	180	(82)	40 (6.2)	Alloy 600	40 (6.2)	304 SS	
Chromic	180	(82)	40 (6.2)	Titanium	N/A	N/A	
Citric	180	(82)	23 (3.6)	Alloy 800	30 (4.6)	Alloy 800	
Fatty Acids	150	(65)	20 (3.1)	316 SS	30 (4.6)	Alloy 800	
Lactic	122	(50)	10 (1.6)	316 SS	N/A	N/A	
Levulinic	180	(82)	40 (6.2)	Alloy 600	40 (6.2)	304 SS	
Malic	122	(50)	10 (1.6)	316 SS	16 (2.5)	Alloy 800	
Nitric (30% max.)	167	(75)	20 (3.1)	316 SS	30 (4.6)	Alloy 800	
Phenol—2-4							
Disulfonic	180	(82)	40 (6.2)	316 SS	40 (6.2)	Alloy 800	
Phosphoric	180	(82)	23 (3.6)	Alloy 800	30 (4.6)	Alloy 800	
Phosphoric (Aerated)	180	(82)	23 (3.6)	304 SS	30 (4.6)	304 SS	

CONTINUED



Tubular Elements and Assembly Selection Guide

Supplemental Applications Chart (Continued)

Heated Material	Max. Operating Temperature °F (°C)		WATROD Element			FIREBAR Element		
			Max. Watt Density W/in ² (W/cm ²)		Sheath Material	Max. Watt Density W/in ² (W/cm ²)		Sheath Material
Proponic (10% max.)	180	(82)	40	(6.2)		Alloy 800	40	
Tannic	167/180	(75/82)	23/40	(3.6/6.2)	Steel/304 SS	40	(6.2)	304 SS
Tartaric	180	(82)	40	(6.2)	316 SS	40	(6.2)	Alloy 800
Acetaldehyde	180	(82)	10	(1.6)	Alloy 800	16	(2.4)	Alloy 800
Acetone	130	(54)	10	(1.6)	304 SS	16	(2.4)	304 SS
Air			①	①	Alloy 800	①	①	Alloy 800
Alcyl alcohol	200	(93)	10	(1.6)	Alloy 800	16	(2.4)	Alloy 800
Alkaline solutions	212	(100)	40	(6.2)	Steel	48	(7.4)	304 SS
Aluminum acetate	122	(50)	10	(1.6)	316 SS	16	(2.5)	Alloy 800
Aluminum potassium sulfate	212	(100)	40	(6.2)	Alloy 800	N/A	N/A	N/A
Ammonia gas	①	①	①	①	Steel	①	①	304 SS
Ammonium acetate	167	(75)	23	(3.6)	Alloy 800	30	(4.6)	Alloy 800
Amyl acetate	240	(115)	23	(3.6)	Alloy 800	30	(4.6)	Alloy 800
Amyl alcohol	212	(100)	20	(3.1)	304 SS	30	(4.6)	304 SS
Aniline	350	(176)	23	(3.6)	304 SS	30	(4.6)	304 SS
Asphalt	200-500	(93-260)	4-10	(0.6 - 1.6)	Steel	6-12	(0.9 - 1.8)	304 SS
Barium hydroxide	212	(100)	40	(6.2)	316 SS	40	(6.2)	Alloy 800
Benzene, liquid	150	(65)	10	(1.6)	Alloy 800	16	(2.5)	304 SS
Butyl acetate	225	(107)	10	(1.6)	316 SS	16	(2.5)	Alloy 800
Calcium bisulfate	400	(204)	20	(3.1)	316 SS	N/A	N/A	N/A
Calcium chloride	200	(93)	5-8	(0.8 - 1.2)	Alloy 600	N/A	N/A	N/A
Carbon monoxide	—	—	①	①	Alloy 800	①	①	Alloy 800
Carbon tetrachloride	160	(71)	23	(3.6)	Alloy 800	30	(4.6)	Alloy 800
Caustic soda:								
2%	210	(98)	48	(7.4)	Alloy 800	—	—	Contact Watlow
10% concentrate	210	(98)	23	(3.6)	Alloy 800	—	—	Contact Watlow
75%	180	(82)	23	(3.6)	Alloy 800	—	—	Contact Watlow
Citric juices	185	(85)	23	(3.6)	Alloy 800	30	(4.6)	Alloy 800
Degreasing solution	275	(135)	23	(3.6)	Steel	30	(4.6)	304 SS
Dextrose	212	(100)	20	(3.1)	304 SS	30	(4.6)	304 SS
Dyes and pigments	212	(100)	23	(3.6)	304 SS	30	(4.6)	304 SS

Electroplating Baths:

Cadmium	180	(82)	40	(6.2)	304 SS	40	(6.2)	304 SS
Alloy 800	180	(82)	40	(6.2)	316 SS	N/A	N/A	N/A
Dilute cyanide	180	(82)	40	(6.2)	316 SS	N/A	N/A	N/A
Rochelle cyanide	180	(82)	40	(6.2)	316 SS	N/A	N/A	N/A
Sodium cyanide	180	(82)	40	(6.2)	316 SS	N/A	N/A	N/A
Potassium cyanide	180	(82)	40	(6.2)	316 SS	40	(6.2)	304 SS
Ethylene glycol	300	(148)	30	(4.6)	Steel	40	(6.2)	304 SS
Formaldehyde	180	(82)	10	(1.6)	304 SS	16	(2.5)	304 SS
Freon® gas	300	(148)	2-5	(0.3 - 0.8)	Steel			304 SS
Gasoline	300	(148)	23	(3.6)	Steel	30	(4.6)	304 SS

CONTINUED

① Contact your Watlow representative.



Tubular Elements and Assembly Selection Guide

Supplemental Applications Chart (Continued)

Heated Material	Max. Operating Temperature °F (°C)		WATROD Element		FIREBAR Element			
			Max. Watt Density W/in ² (W/cm ²)	Sheath Material	Max. Watt Density W/in ² (W/cm ²)	Sheath Material		
Gelatin liquid	150	(65)	23	(3.6)	304 SS	30	(4.6)	304 SS
Gelatin solid	150	(65)	5	(0.8)	304 SS	7	(1.0)	304 SS
Glycerin	500	(260)	10	(1.6)	Alloy 800	12	(1.9)	304 SS
Glycerol	212	(100)	23	(3.6)	Alloy 800	30	(4.6)	304 SS
Grease:								
Liquid	—	—	23	(3.6)	Steel	30	(4.6)	304 SS
Solid	—	—	5	(0.8)	Steel	7	(1.0)	304 SS
Hydrazine	212	(100)	16	(2.5)	304 SS	20	(3.1)	304 SS
Hydrogen	①	①	—	—	Alloy 800	①	①	Alloy 800
Hydrogen chloride	①	①	—	—	Alloy 600	①	①	N/A
Hydrogen sulfide	①	①	—	—	316 SS (heavy wall)	①	①	N/A
Magnesium chloride	212	(100)	40	(6.2)	Alloy 600	40	(6.2)	Alloy 800
Magnesium sulfate	212	(100)	40	(6.2)	304 SS	40	(6.2)	304 SS
Magnesium sulfate	212	(100)	40	(6.2)	316 SS	40	(6.2)	304 SS
Methanol gas	①	①	—	—	304 SS	①	①	304 SS
Methylamine	180	(82)	20	(3.1)	Alloy 600	30	(4.6)	304 SS
Methylchloride	180	(82)	20	(3.1)	Alloy 800	N/A	N/A	N/A
Molasses	100	(37)	4-5	(0.6 - 0.8)	304 SS	5-8	(0.8 - 1.2)	304 SS
Molten salt bath	800-900	(426-482)	25-30	(3.8 - 4.6)	Alloy 400	N/A	N/A	N/A
Naphtha	212	(100)	10	(1.6)	Steel	16	(2.5)	304 SS

Oils

Fuel oils:								
Grades 1 and 2 (distillate)	200	(93)	23	(3.6)	Steel	30	(4.6)	304 SS
Grades 4 and 5 (residual)	200	(93)	13	(2.0)	Steel	16	(2.5)	304 SS
Grades 6 and Bunker C (residual)	160	(71)	8	(1.2)	Steel	10	(1.6)	304 SS
Heat transfer oils: ②								
Static	500	(260)	16	(2.5)	Steel	23	(3.6)	304 SS
	600	(315)	10	(1.6)	Steel	16	(2.5)	304 SS
Circulating	500	(260)	23	(3.6)	Steel	30	(4.6)	304 SS
	600	(315)	15	(2.3)	Steel	20	(3.1)	304 SS
Lubrication oils:								
SAE 10, 90-100 SSU @ 130°F	250	(121)	23	(3.6)	Steel	30	(4.6)	304 SS
SAE 20, 120-185 SSU @ 130°F	250	(121)	23	(3.6)	Steel	30	(4.6)	304 SS
SAE 30, 185-255 SSU @ 130°F	250	(121)	23	(3.6)	Steel	30	(4.6)	304 SS
SAE 40, -80 SSU @ 210°F	250	(121)	13	(2.0)	Steel	18	(2.7)	304 SS
SAE 50, 80-105 SSU @ 210°F	250	(121)	13	(2.0)	Steel	18	(2.7)	304 SS

CONTINUED

① Contact your Watlow representative.

② Maximum operating temperatures and watt densities are detailed in *Heat Transfer Oil* charts on page 555.

Reference Data



Tubular Elements and Assembly Selection Guide

Supplemental Applications Chart (Continued)

Heated Material	Max. Operating Temperature °F (°C)		WATROD Element		FIREBAR Element			
			Max. Watt Density W/in ² (W/cm ²)	Sheath Material	Max. Watt Density W/in ² (W/cm ²)	Sheath Material		
Miscellaneous oils:								
Draw bath	600	(315)	23	(3.6)	Steel	30	(4.6)	304 SS
Hydraulic	—	—	15	③ (2.3)	Steel	15	③ (2.3)	304 SS
Linseed	150	(65)	50	(7.7)	Steel	60	(9.3)	304 SS
Mineral	200	(93)	23	(3.6)	Steel	30	(4.6)	304 SS
Vegetable/shortening	400	(204)	16	(2.5)	Steel	23	(3.6)	304 SS
	400	(204)	30	(4.6)	304 SS	40	(6.2)	304 SS
Paraffin or wax (liquid)	150	(65)	16	(2.4)	Steel	20	(3.1)	304 SS
Perchloroethylene	200	(93)	23	(3.6)	Steel	30	(4.6)	304 SS
Potassium chlorate	212	(100)	40	(6.2)	316 SS	N/A	N/A	N/A
Potassium chloride	212	(100)	40	(6.2)	316 SS	N/A	N/A	N/A
Potassium hydroxide	160	(71)	23	(3.6)	Alloy 400	N/A	N/A	N/A
Soap, liquid	212	(100)	20	(3.1)	304 SS	30	(4.6)	304 SS
Sodium acetate	212	(100)	40	(6.2)	Steel	50	(7.7)	304 SS
Sodium cyanide	140	(60)	40	(6.2)	Alloy 800	50	(7.7)	Alloy 800
Sodium hydride	720	(382)	28	(4.3)	Alloy 800	36	(5.5)	Alloy 800
Sodium hydroxide	—	—	—	—	See Caustic Soda	—	—	—
Sodium phosphate	212	(100)	40	(6.2)	Alloy 800	50	(7.7)	304 SS
Steam, flowing	300	(148)	10	(1.6)	Alloy 800	①	①	Alloy 800
	500	(260)	5-10	(0.8-1.6)	Alloy 800	①	①	Alloy 800
	700	(371)	5	(0.8)	Alloy 800	①	①	Alloy 800
Sulfur, molten	600	(315)	10	(1.6)	Alloy 800	12	(1.8)	Alloy 800
Toluene	212	(100)	23	(3.6)	Steel	30	(4.6)	304 SS
Trichlorethylene	150	(65)	23	(3.6)	Steel	30	(4.6)	304 SS
Turpentine	300	(148)	20	(3.1)	304 SS	25	(3.8)	304 SS

Water

Clean	212	(100)	60	(9.3)	Alloy 800	45	(7)	Alloy 800
Deionized	212	(100)	60	(9.3)	316 SS (passivated)	90	(14)	Alloy 800
Deminerlized	212	(100)	60	(9.3)	316 SS (passivated)	90	(14)	Alloy 800
Potable	212	(100)	60	(9.3)	Alloy 800	45	(7)	Alloy 800
Process	212	(100)	48	(9.3)	Alloy 800			Contact Watlow

① Contact your Watlow representative.

③ Per API standards.



Tubular Elements and Assembly Selection Guide

Free Cross Sectional Area of WATROD and FIREBAR Circulation Heaters

Free cross sectional areas from the chart are in square feet. Calculations are based on:

- Flange 12 inches and under, pipes are schedule 40
- Flanges 14 inches and above, pipes are standard wall thickness 0.375 in. (9.5 mm)
- All WATROD heating elements are 0.475 in. (12 mm) diameter

Circulation Heater Size in.	Free Cross Sectional Area in Square Feet (Number of Elements in Parenthesis)			
WATROD				
2½ NPT	0.044	(3)		
3 Flange	0.044	(3)	0.037	(6)
4 Flange	0.074	(6)		
5 Flange	0.124	(6)	0.117	(9)
6 Flange	0.172	(12)	0.164	(15)
8 Flange	0.303	(18)	0.296	(21)
10 Flange	0.481	(27)	0.460	(36)
12 Flange	0.697	(36)	0.652	(54)
14 Flange	0.848	(45)	0.781	(72)
16 Flange	1.091	(72)	1.054	(87)
18 Flange	1.372	(102)	1.357	(108)
20 Flange	1.748	(108)	1.733	(114)
			0.288	(24)
			1.017	(102)
			1.342	(114)
			1.704	(126)
FIREBAR				
2½ NPT	0.0417	(3)		



Tubular Elements and Assembly Selection Guide

Heat Transfer Oil Chart

Heat Transfer Fluid	Recommended		Flammability Data °F (°C)			Min. Velocity Thru Heater in Feet/second at W/in ² (M/second at W/cm ²)								
	Max. Temperature °F (°C)		Flash Point		Fire Point		8 (1.2)		16 (2.8)		23 (3.6)		30 (4.7)	
	Process F (°C)	Sheath °F (°C)	°F (°C)	°F (°C)	°F (°C)	°F (°C)	W/in ² (W/cm ²)	W/in ² (W/cm ²)	W/in ² (W/cm ²)	W/in ² (W/cm ²)	W/in ² (W/cm ²)	W/in ² (W/cm ²)		
Calflo HTF	600 (316)	650 (343)	414 (212)	462 (239)	670 (354)	1.5 (0.5)	3.0 (0.9)	5.0 (1.52)	7.0 (2.1)					
Calflo AF	550 (288)	600 (316)	400 (204)	437 (225)	650 (343)	1.5 (0.5)	3.0 (0.9)	5.0 (1.52)	7.0 (2.1)					
Dowtherm® A	750 (399)	835 (446)	255 (124)	275 (135)	1150 (621)	0.5 (0.15)	1.0 (0.3)	2.0 (0.61)	3.0 (0.9)					
Dowtherm® G	700 (371)	775 (413)	305 (152)	315 (157)	1150 (621)	0.7 (0.2)	1.5 (0.5)	2.5 (0.75)	3.5 (1.1)					
Dowtherm® J	575 (302)	650 (343)	145 (63)	155 (68)	806 (430)	1.0 (0.3)	2.0 (0.61)	3.0 (0.9)	4.5 (1.37)					
Dowtherm® LF	600 (316)	675 (357)	260 (127)	280 (138)	1020 (549)	0.7 (0.2)	1.5 (0.5)	2.5 (1.75)	3.5 (1.1)					
Dowtherm® HT	650 (343)	700 (371)	no data no data	no data no data	no data no data	1.5 (0.5)	2.5 (0.75)	3.5 (1.1)	5.0 (1.52)					
Dowtherm® Q	625 (329)	700 (371)	no data no data	no data no data	773 (412)	0.7 (0.2)	1.5 (0.5)	2.5 (0.75)	3.5 (1.1)					
Marlotherm S	662 (350)	698 (370)	374 (190)	no data no data	932 (500)	1.5 (0.5)	3.0 (0.9)	5.0 (1.52)	7.0 (2.1)					
Mobiltherm 603	590 (310)	625 (329)	380 (193)	no data no data	no data no data	1.5 (0.5)	3.0 (0.9)	5.0 (1.52)	7.0 (2.1)					
Multitherm IG-2	600 (316)	650 (343)	440 (227)	500 (260)	700 (371)	0.8 (0.24)	1.7 (0.52)	2.3 (0.7)	3.0 (0.9)					
Multitherm PG-1	600 (316)	640 (338)	340 (171)	385 (196)	690 (368)	1.0 (0.3)	2.0 (0.61)	3.0 (0.9)	4.0 (1.22)					
Para Cymene	600 (316)	650 (343)	117 (47)	152 (72)	817 (438)	0.7 (0.2)	1.5 (0.5)	2.5 (0.75)	3.5 (1.1)					
Syltherm 800	750 (399)	800 (427)	350 (177)	380 (193)	725 (385)	1.5 (0.5)	3.0 (0.9)	5.0 (1.52)	7.0 (2.1)					
Syltherm XLT	500 (260)	550 (288)	116 (47)	130 (54)	662 (350)	1.5 (0.5)	2.5 (0.75)	4.0 (1.22)	5.0 (1.52)					
Texatherm	600 (316)	640 (338)	430 (221)	no data no data	no data no data	2.0 (0.61)	4.0 (1.22)	6.0 (1.83)	8.0 (2.4)					
Thermia 33	600 (316)	650 (343)	455 (235)	495 (257)	no data no data	1.5 (0.5)	3.0 (0.9)	5.0 (1.52)	7.0 (2.1)					
Therminol 44	400 (204)	475 (246)	405 (207)	438 (228)	705 (374)	1.0 (0.3)	2.0 (0.61)	3.0 (0.9)	4.0 (1.22)					
Therminol 55	550 (288)	605 (318)	350 (177)	410 (210)	675 (357)	1.5 (0.5)	2.5 (0.75)	3.5 (1.1)	5.0 (1.52)					
Therminol 59	600 (316)	650 (343)	302 (150)	335 (168)	770 (410)	1.5 (0.5)	2.5 (0.75)	3.5 (1.1)	5.0 (1.52)					
Therminol 60	620 (327)	655 (346)	310 (154)	320 (160)	835 (448)	1.5 (0.5)	3.0 (0.9)	5.0 (1.52)	7.0 (2.1)					
Therminol 68	650 (343)	705 (374)	350 (177)	380 (183)	705 (374)	1.5 (0.5)	2.5 (0.75)	3.0 (0.9)	4.5 (1.37)					
Therminol 75	750 (399)	805 (429)	390 (199)	440 (227)	1000 (538)	1.0 (0.3)	2.0 (0.61)	3.0 (0.9)	4.0 (1.22)					
Therminol LT	600 (316)	650 (343)	134 (57)	150 (66)	805 (429)	1.5 (0.5)	2.5 (0.75)	4.0 (1.22)	5.0 (1.52)					
Therminol VP-1	750 (399)	800 (427)	255 (124)	280 (127)	1150 (621)	1.0 (0.3)	2.0 (0.61)	3.0 (0.9)	4.0 (1.22)					
U-Con 500	500 (260)	550 (288)	540 (282)	600 (316)	750 (399)	1.0 (0.3)	2.0 (0.61)	3.0 (0.9)	4.0 (1.22)					

