

# EZ-ZONE<sup>®</sup> PM Express Users Manual



## PID Controller



**TOTAL  
CUSTOMER  
SATISFACTION**  
3 Year Warranty

**ISO 9001**  
Registered Company  
Winona, Minnesota, USA

1241 Bundy Boulevard., Winona, Minnesota USA 55987

Phone: +1 (507) 454-5300, Fax: +1 (507) 452-4507 <http://www.watlow.com>

0600-0065-0000 Rev. D

Made in the U.S.A.



April 2010

1 2  
3 4

### Safety Information

We use note, caution and warning symbols throughout this book to draw your attention to important operational and safety information.

A "NOTE" marks a short message to alert you to an important detail.  
A "CAUTION" safety alert appears with information that is important for protecting your equipment and performance. Be especially careful to read and follow all cautions that apply to your application.  
A "WARNING" safety alert appears with information that is important for protecting you, others and equipment from damage. Pay very close attention to all warnings that apply to your application.

The electrical hazard symbol, ⚡ (a lightning bolt in a triangle) precedes an electric shock hazard CAUTION or WARNING safety statement. Further explanations follow:

Symbol	Explanation
	CAUTION – Warning or Hazard that needs further explanation than label on unit can provide. Consult users manual for further information.
	ESD Sensitive product, use proper grounding and handling techniques when installing or servicing product.
	Unit protected by double/reinforced insulation for shock hazard prevention.
	Do not throw in trash, use proper recycling techniques or consult manufacturer for proper disposal.
	Unit can be powered with either alternating current (ac) voltage or direct current (dc) voltage.

	Unit is a Listed device per Underwriters Laboratories <sup>®</sup> . It has been evaluated to United States and Canadian requirements for Process Control Equipment. UL 61010 and CSA C22.2 No. 61010. File E185611 QUXX, QUXX7. See: <a href="http://www.ul.com">www.ul.com</a>
	Unit is a Listed device per Underwriters Laboratories <sup>®</sup> . It has been evaluated to United States and Canadian requirements for Hazardous Locations Class 1 Division II Groups A, B, C and D. ANSI/ISA 12.12.01-2007, File E184390 QUZW, QUZW7. See: <a href="http://www.ul.com">www.ul.com</a>
	Unit is compliant with European Union directives. See Declaration of Conformity for further details on Directives and Standards used for Compliance.
	Unit has been reviewed and approved by Factory Mutual as a Temperature Limit Device per FM Class 3545 standard. See: <a href="http://www.fmglobal.com">www.fmglobal.com</a>
	Unit has been reviewed and approved by CSA International for use as Temperature Indicating-Regulating Equipment per CSA C22.2 No. 24. See: <a href="http://www.csa-international.org">www.csa-international.org</a>

### Warranty

The EZ-ZONE<sup>®</sup> PM is manufactured by ISO 9001-registered processes and is backed by a three-year warranty to the first purchaser for use, providing that the units have not been misapplied. Since Watlow has no control over their use, and sometimes misuse, we cannot guarantee against failure. Watlow's obligations hereunder, at Watlow's option, are limited to replacement, repair or refund of purchase price, and parts which upon examination prove to be defective within the warranty period specified. This warranty does not apply to damage resulting from transportation, alteration, misuse or abuse. The purchaser must use Watlow parts to maintain all listed ratings.

### Technical Assistance

If you encounter a problem with your Watlow controller, review your configuration information to verify that your selections are consistent with your application: inputs, outputs, alarms, limits, etc. If the problem persists, you can get technical assistance from your local Watlow representative (see back cover), by e-mailing your questions to [wintechsupport@watlow.com](mailto:wintechsupport@watlow.com) or by dialing +1 (507) 494-5656 between 7 a.m. and 5 p.m., Central Standard Time (CST). Ask for an Applications Engineer. Please have the following information available when calling:

- Complete model number
- All configuration information
- User's Manual
- Factory Page

### Return Material Authorization (RMA)

1. Call Watlow Customer Service, (507) 454-5300, for a Return Material Authorization (RMA) number before returning any item for repair. If you do not know why the product failed, contact an Application Engineer or Product Manager.

The EZ-ZONE PM Controller User's Manual is copyrighted by Watlow Winona, Inc., © April 2010 with all rights reserved. The EZ-ZONE PM is covered by U.S. Patent No. 6,005,577 and Patents Pending

### Overview

The EZ-ZONE PM Express controllers take the pain out of solving your thermal loop requirements while reducing the cost of control-loop ownership. You can order this control as a single loop PID controller with a high-amperage power output in either a 16<sup>th</sup> or 32<sup>nd</sup> DIN panel-mount package. It just got a whole lot easier to solve the thermal requirements of your system. Because the EZ-ZONE family of controls are highly scalable

where you **pay only for what you need**. So if you are looking for a single or multi-loop PID controller, an over-under limit controller or an integrated controller (PID and Limit), the EZ-ZONE family of controls can meet all of your needs. Point your browser to <http://www.watlow.com> to find out more about the EZ-ZONE family of controls. For this particular control, serial communications is accomplished using Watlow's Standard Bus protocol. If the need arises to network your controls and communicate using other popular protocols such as Modbus RTU/TCP<sup>®</sup>, EtherNet/IP<sup>™</sup>, DeviceNet<sup>™</sup> or Profibus DP consider using the EZ-ZONE family Remote User Interface/Gateway (RUI/GTW).

## Installation and Wiring

Dimensions 1/32 DIN

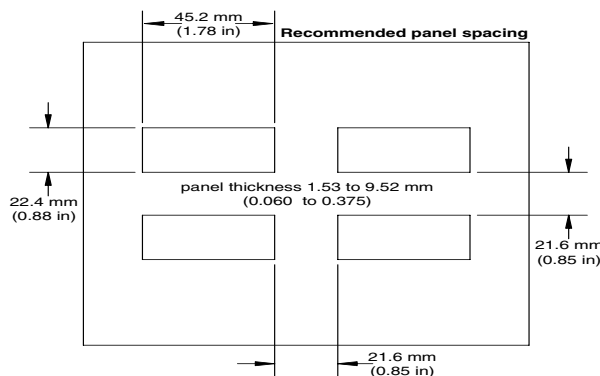
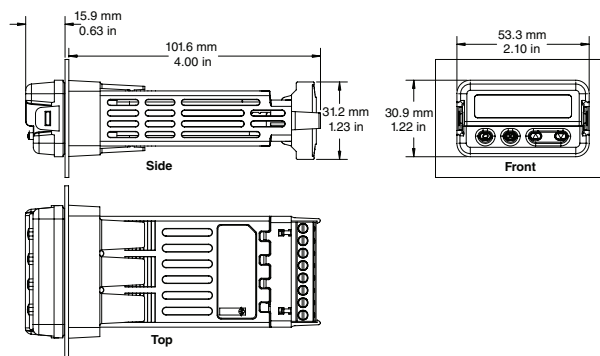

1/32 DIN Maximum Cutout

# Dimensions 1/16 DIN

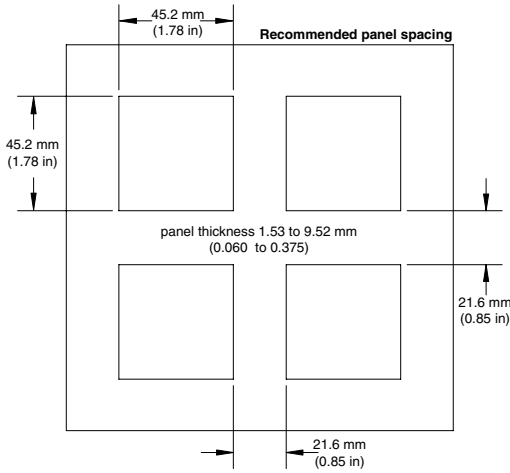
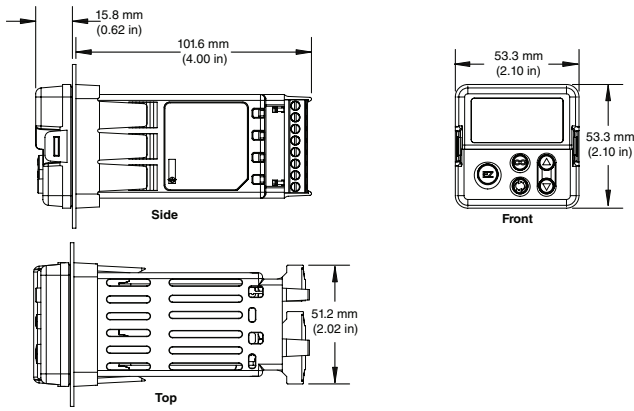

## Installation

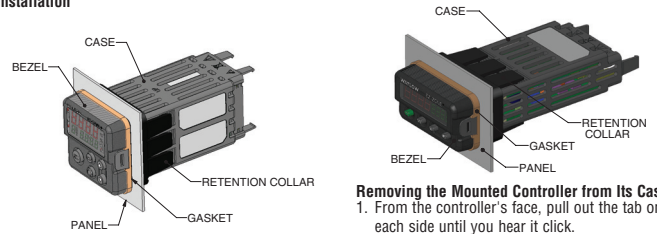

### Removing the Mounted Controller from Its Case

1. From the controller's face, pull out the tab on each side until you hear it click.



Pull out the tab on each side until you hear it click.

Grab the unit above and below the face and pull forward.

- Make the panel cutout using the mounting template dimensions in this chapter. Insert the case assembly into the panel cutout.
- While pressing the case assembly firmly against the panel, slide the mounting collar over the back of the controller.

If the installation does not require a NEMA 4X seal, slide the mounting collar up to the back of the panel tight enough to eliminate the spacing between the gasket and the panel.

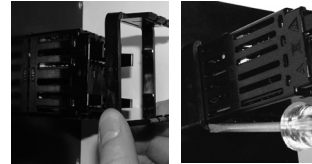

Slide the mounting collar over the back of the controller.

Place the blade of a screwdriver in the notch of the mounting collar assembly.

- For a NEMA 4X seal, place the blade of a screwdriver in the notch of the mounting collar assembly and push toward the panel while applying pressure to the face of the controller. Don't be afraid to apply enough pressure to properly install the controller. The seal system is compressed more by mating the mounting collar tighter to the front panel (see picture). If you can move the case assembly back and forth in the cutout, you do not have a proper seal. The tabs on each side of the mounting collar have teeth that latch into the ridges on the sides of the controller. Each tooth is staggered at a different depth from the front so that only one of the tabs, on each side, is locked onto the ridges at a time.

- Once the sides are released, grab the unit above and below the face with two hands and pull the unit out. If it is difficult to pull the unit out, remove the connectors from the back of the controller. This should make it easier to remove.

#### Warning:

All electrical power to the controller and controlled circuits must be disconnected before removing the controller from the front panel or disconnecting other wiring. Failure to follow these instructions may cause an electrical shock and/or sparks that could cause an explosion in class 1, div. 2 hazardous locations.

### Returning the Controller to its Case

- Ensure that the orientation of the controller is correct and slide it back into the housing.
- Using your thumbs push on either side of the controller until both latches click.

#### Note:

The controller is keyed so if it feels that it will not slide back in do not force it. Check the orientation again and reinsert after correcting.

### Chemical Compatibility

This product is compatible with acids, weak alkalis, alcohols, gamma radiation and ultra-violet radiation.

This product is not compatible with strong alkalis, organic solvents, fuels, aromatic hydrocarbons, chlorinated hydrocarbons, esters and keytones.

56  
78

## Terminal Definitions

Slot C	Terminal Function	Model	
98 99	power input: ac or dc+ power input: ac or dc-	PM_(C)___ - AAAAB __	
CF CD CE	Standard Bus EIA-485 common Standard Bus EIA-485 T-/R- Standard Bus EIA-485 T+/R+	PM_(C)___ - AAAAB __	
Slot A			
Input 1			
T1 S1 R1	S2 (RTD) or current +, S3 (RTD), thermocouple -, current - or volts - S1 (RTD), thermocouple + or volts +	Universal Sensor input 1: all configurations	
Outputs	Terminal Function	Configuration	
1 2			
X1 W1 Y1	common (Any switched dc output can use.) dc- (open collector) dc+	Switched dc/open collector, output 1: PM_(C)_C_- AAAB __	
W2 Y2	dc- dc+	Switched dc, output 2: PM_(C)_C_- AAAB __	
F1 G1 H1	voltage or current - voltage + current +	Universal Process, output 1: PM_(C)_F_- AAAB __	
L1 K1 J1	normally open common normally closed	Mechanical Relay 5 A, Form C, output 1: PM_(C)_E_- AAAB __	
L2 K2	normally open common	NO-ARC 15 A, Form A, output 2: PM6(C)_H_- AAAB __	
L2 K2	normally open common	Mechanical Relay 5 A, Form A, output 2: PM_(C)_J_- AAAB __	
L1 K1	L2 K2	normally open common	Solid-State Relay 0.5 A, Form A output 1: PM_(C)_K_- AAAB __ output 2: PM_(C)_K_- AAAB __

### Note:

In the pictures below notice that the Slot A connector does not show labeling for the outputs. Labeling for Slot A outputs is based on the controller part number.

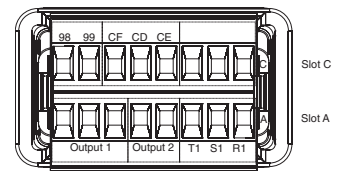
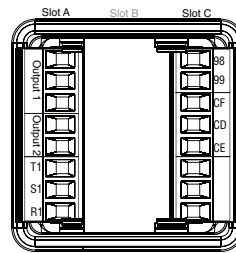

#### Warning:

Use National Electric (NEC) or other country-specific standard wiring and safety practices when wiring and connecting this controller to a power source and to electrical sensors or peripheral devices. Failure to do so may result in damage to equipment and property, and/or injury or loss of life.

#### Note:

- Maximum wire size termination and torque rating:
- 0.0507 to 3.30 mm<sup>2</sup> (30 to 12 AWG) single-wire termination or two 1.31 mm<sup>2</sup> (16 AWG)
  - 0.8 Nm (7.0 lb-in.) torque

#### Note:

Adjacent terminals may be labeled differently, depending on the model number.

#### Note:

To prevent damage to the controller, do not connect wires to unused terminals.

#### Note:

Maintain electrical isolation between analog input 1 and switched dc/open collector outputs.

## Power

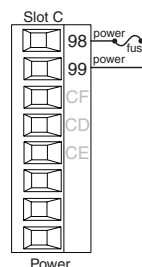

- 47 to 63 Hz
- 10VA maximum power consumption

### Low Power

- 12 to 40V<sub>DC</sub> (dc)
- 20 to 28V<sub>AC</sub> (ac) Semi Sig F47

### High Power

- 85 to 264V<sub>AC</sub> (ac)
- 100 to 240V<sub>AC</sub> (ac) Semi Sig F47

**Note:**  
In the drawings below for each input notice that the Slot A connector labeling is identified.

**Note:**  
When using a 2 wire RTD, jumper S1 and T1 together

**Inputs**  
All inputs shown below represent input 1 (the only input) and are to be connected to slot A of the PID Controller.

**Process Volts**

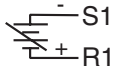

**Process Amperes**

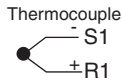
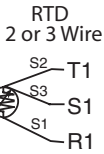
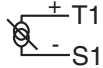

- Process Volts and Amperes**
- 4 to 20 mA @ 100 Ω input impedance
  - 0 to 10V= (dc) @ 20 kΩ input impedance
  - Scalable
- Resistance Temperature Detector (RTD)**
- Platinum, 100 Ω @ 0°C
  - Calibration to DIN curve (0.00385 Ω/Ω°C)
  - 20 Ω total lead resistance
  - RTD excitation current of 0.09 mA typical. Each ohm of lead resistance may affect the reading by 0.03°C.
  - For 3-wire RTDs, the S1 lead must be connected to R1.
  - For best accuracy use a 3-wire RTD to compensate for lead-length resistance. All three

- lead wires must have the same resistance.
- Thermocouple**
- 2 KΩ maximum source resistance
  - >20 MΩ input impedance
  - 3 microampere open-sensor detection
  - Thermocouples are polarity sensitive. The negative lead must be connected to S1.
  - To reduce errors, the extension wire for thermocouples must be of the same alloy as the thermocouple.

**Power Supply Note:**  
Switched dc and Process outputs use a common power supply with a maximum current output of 40mA. As an example, supplied current (mA) from output 1 and 2 can be 20/20, 30/10, 40/0, 10/30, etc...

**Outputs**  
Please note all outputs are connected exclusively to slot A. Output availability is based on the part number of your PID Control.

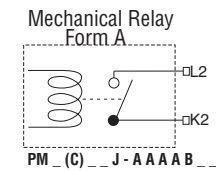
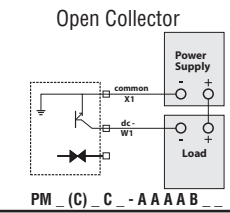
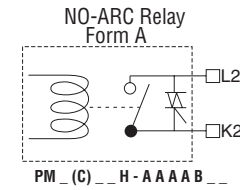
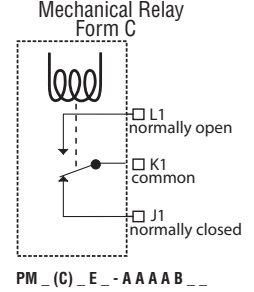
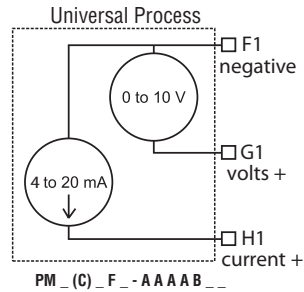
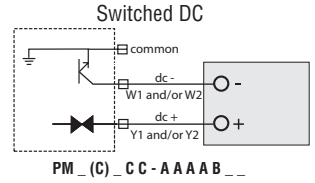
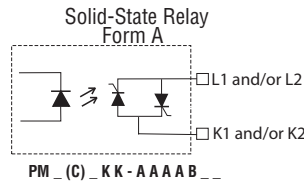

**Quencharc Note:**  
Switching pilot duty inductive loads (relay coils, solenoids, etc.) with the mechanical relay, solid state relay or open collector output options requires use of an R.C. suppressor.

9 10  
11 12

- Switched DC**
- Supplied current up to a maximum of 40 mA. See Power Supply note above.
  - Short circuit limited to <50 mA
  - 22 to 32V= (dc) open circuit voltage
  - Use dc- and dc+ to drive external solid-state relay.
  - DIN-A-MITE compatible
    - single-pole: up to 4 in parallel or 4 in series
    - 2-pole: up to 2 in parallel or 2 in series
    - 3-pole: up to 2 in series
- Open Collector**
- 100 mA maximum output current sink
  - 30V= (dc) maximum supply voltage
  - Any switched dc output can use the common terminal.
  - Use an external power supply to control a dc load, with the load positive to the positive of the power supply, the load negative to the open collector and common to the power supply negative.
- See Quencharc note.
- Mechanical Relay Form C**
- 5 A at 240V~ (ac) or 30V= (dc) maximum resistive load
  - 20 mA at 24V minimum load
  - 125 VA pilot duty @ 120/240V~ (ac), 25 VA at 24V~ (ac)
  - 100,000 cycles at rated load
  - Output does not supply power.
  - For use with ac or dc
- See Quencharc note.
- Mechanical Relay Form A**
- 5 A at 240V~ (ac) or 30V= (dc) maximum resistive load
  - 20 mV at 24V minimum load
  - 125 VA pilot duty @ 120/240V~ (ac), 25 VA at 24V~ (ac)
  - 100,000 cycles at rated load
  - Output does not supply power.
  - For use with ac or dc
- See Quencharc note.
- NO-ARC Relay Form A**
- 15 A at 85 to 264V~ (ac) resistive load only
  - 1/16 DIN models only
  - 2,000,000 cycle rating for NO-ARC circuit
- 100 mA minimum load
  - 2 mA maximum off state leakage
  - Do not use on dc loads.
  - Output does not supply power.
- Solid-State Relay Form A**
- 0.5 A at 20 to 264V~ (ac) maximum resistive load
  - 20 VA 120/240V~ (ac) pilot duty
  - Opto-isolated, without contact suppression
  - Maximum off state leakage of 105 microamperes
  - Output does not supply power
  - Do not use on dc loads.
  - See Quencharc note.
- Universal Process**
- 4 to 20 mA into 800 Ω maximum load
  - 0 to 10V= (dc) into voltage 1 kΩ minimum load
  - Scalable
  - Output supplies power (See Power Supply note above).
  - Cannot use voltage and current outputs at same time

**Keys & Displays**  
16<sup>th</sup> DIN PID Controller

**Zone Display:**  
When [Zone] (found in the Factory Page) is set to on, indicates the controller zone.  
[1] to [9] = zones 1 to 9  
[A] = zone 10 [E] = zone 14  
[B] = zone 11 [F] = zone 15  
[C] = zone 12 [H] = zone 16  
[D] = zone 13

**Upper Display:**  
In the Operations Menu, displays the process value, otherwise displays the value of the parameter in the lower display.

**Temperature Units Indicator Lights:**  
Indicates whether the temperature is displayed in Fahrenheit or Celsius.

**Output Activity:**  
Number lights indicate activity of outputs 1 and 2.

**Percent Units Indicator:**  
Lights when the controller is displaying values as a percentage or when the open-loop set point is displayed.

**Communications Activity:**  
Flashes when another device is communicating with this controller.

**Up and Down Keys:** ⬆ ⬇  
In the Operations Menu, adjusts the set point in the lower display. In other pages, changes the upper display to a higher or lower value, or changes a parameter selection.

**Advance Key:** ⬆  
Advances through parameter prompts.

**A/M Key:**  
This key will toggle the control mode between the current value of the C.M prompt (Off, MAN, AUto) and Manual when the A/M button is pushed and held for 3 seconds.

**Infinity Key:** ∞  
Clears and Silences alarms, press to back up one level, or press and hold for two seconds to return to the Operations Menu.

**Lower Display:**  
Indicates the set point or output power value during operation, or the parameter whose value appears in the upper display.

**32<sup>nd</sup> DIN PID Controller**

With a few exceptions, all of the key functions described for the 16<sup>th</sup> DIN PID Controller apply to the 32<sup>nd</sup> DIN PID Controller as well.

**Left Display:**  
In the Operations Menu, displays the process value, otherwise displays the value of the parameter in the left display.

**Right Display:**  
Indicates the set point or output power value during operation, or the parameter whose value appears in the right display.

**Responding to a Displayed Message (16<sup>th</sup> or 32<sup>nd</sup> DIN)**

- An active message will cause the display to toggle between the normal settings and the active message in the upper or left display and [Attn] in the lower or right display. Your response will depend on the message and the controller settings. Some messages, such as Tuning, indicate that a process is underway. If a message is generated in the right or lower display that can be cleared (such as [ALH]), simply push the infinity ∞ key to execute the action ([CLR]).
- [ALL] Alarm Low 1 (sensor input below low alarm set point)
  - [ALH] Alarm High 1 (sensor input above high alarm set point)
  - [ALE] Alarm Error 1 (alarm state cannot be determined due to lack of sensor input)
  - [ERI] Error Input 1 (sensor is not providing a valid signal to the control)
  - [EUN] Tuning (controller is autotuning the control loop)
  - [RPT] Ramping (controller is ramping to a new set point)

Upon power up of the control, using the advance key will scroll through the various prompts found in the Operations Menu. At any point within the Operations menu to return to the default display push the Infinity key.

### Operations Menu

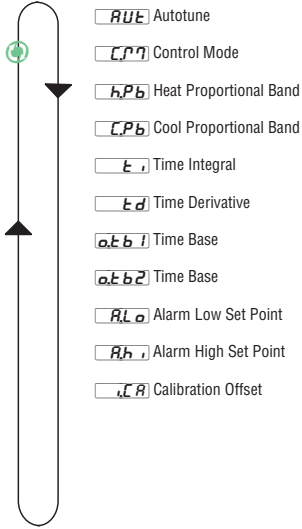

Operations Menu 16 <sup>th</sup> & 32 <sup>nd</sup> DIN PID Controller		
Display	Parameter Name Description	Range (Defaults are shown bold)
<input type="checkbox"/> <b>AUT</b> [AUT]	<b>Autotune</b> Start an autotune. While active the upper or left and lower or right display will flash <b>EUn</b> and <b>REEn</b> . Appears if: Heat or cool algorithm set to PID	<input type="checkbox"/> <b>no</b> No <input checked="" type="checkbox"/> <b>YES</b> Yes
<input type="checkbox"/> <b>C.M</b> [C.M]	<b>Control Mode Active</b> View the current control mode. Appears if: Always	<input type="checkbox"/> <b>OFF</b> Off <input checked="" type="checkbox"/> <b>AUTO</b> Auto <input type="checkbox"/> <b>MAN</b> Manual
<input type="checkbox"/> <b>h.Pb</b> [h.Pb]	<b>Heat Proportional Band</b> Set the PID proportional band for the heat outputs. Appears if: Heat algorithm set to PID	0 to 9,999.000°F or units 0 to 5,555.000°C <b>Units, 25.0°F or 14.0°C</b>
<input type="checkbox"/> <b>C.Pb</b> [C.Pb]	<b>Cool Proportional Band</b> Set the PID proportional band for the cool outputs. Appears if: Cool algorithm set to PID	0 to 9,999.000°F or units 0 to 5,555.000°C <b>Units, 25.0°F or 14.0°C</b>
<input type="checkbox"/> <b>t.i</b> [ti]	<b>Time Integral</b> Set the PID integral for the outputs. Appears if: Heat or cool algorithm set to PID	0 to 9,999 seconds per repeat <b>180.0</b>
<input type="checkbox"/> <b>t.d</b> [td]	<b>Time Derivative</b> Set the PID derivative time for the outputs. Appears if: Heat or cool algorithm set to PID	0 to 9,999 seconds <b>0.0 seconds</b>
<input type="checkbox"/> <b>o.tb1</b> [o.tb1]	<b>Time Base Output 1</b> Set the time base for fixed-time-base control. Appears if: Output 1 set to heat or cool with control algorithm set to PID.	0.1 to 60.0 seconds (solid-state relay or switched dc) 5.0 to 60.0 seconds (mechanical relay & NO-ARC power control) <b>1 sec. [SSR &amp; sw dc], 20.0 sec. [mech. relay &amp; NO-ARC]</b>
<input type="checkbox"/> <b>o.tb2</b> [o.tb2]	<b>Time Base Output 2</b> Set the time base for fixed-time-base control. Appears if: Output 2 set to heat or cool with control algorithm set to PID.	0.1 to 60.0 seconds (solid-state relay or switched dc) 5.0 to 60.0 seconds (mechanical relay & NO-ARC power control) <b>1 sec. [SSR &amp; sw dc], 20.0 sec. [mech. relay &amp; NO-ARC]</b>
<input type="checkbox"/> <b>A.Lo</b> [A.Lo]	<b>Alarm Low Set Point</b> Process - set the process value that will trigger a low alarm. Deviation - set the span of units from the closed loop set point that will trigger a low alarm. Appears if: If Alarm Type (A.ty) is set to Process or Deviation Alarm	-1,999.000 to 9,999.000°F or units -1,128.000 to 5,537.000°C <b>Units, 32.0°F or 0.0°C</b>
<input type="checkbox"/> <b>A.Hi</b> [A.Hi]	<b>Alarm High Set Point</b> Process - set the process value that will trigger a high alarm. Deviation - set the span of units from the closed loop set point that will trigger a high alarm. Appears if: If Alarm Type (A.ty) is set to Process or Deviation Alarm	-1,999.000 to 9,999.000°F or units -1,128.000 to 5,537.000°C <b>Units, 300.0°F or 150.0°C</b>
<input type="checkbox"/> <b>i.CA</b> [i.CA]	<b>Calibration Offset</b> Set an offset value for a process output. Appears if: Always	-1,999.000 to 9,999.000°F or units -1,110.555 to 5,555.000°C <b>0.0</b>

13 | 14  
15 | 16

To enter the Setup Menu push and hold the up and down arrow keys for approximately 3 seconds. Once there, push the green advance key to scroll through to the prompt of choice and then use the up and down arrow keys to change the range. At any point within the Setup menu to return to the default display push the Infinity key.

### Setup Menu

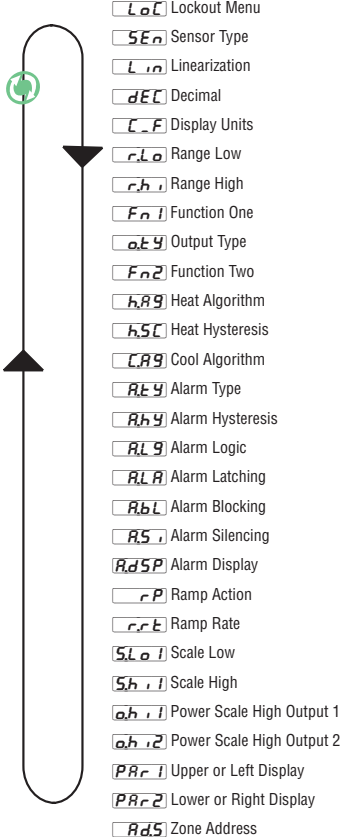

Setup Menu 16 <sup>th</sup> & 32 <sup>nd</sup> DIN PID Controller		
Display	Parameter Name Description	Range (Defaults are shown bold)
<input type="checkbox"/> <b>LoC</b> [LoC]	<b>Lockout Menu</b> Set the security clearance level. The user can access the selected level and all lower levels. Appears if: Always	1 to 5 1 Operations Menu (read only, A/M button disabled)* 2 Operations Menu (A/M button disabled, Set point R/W)* 3 Operations Menu (A/M button enabled, Set point R/W, Control Mode R/W)* 4 Operations Menu R/W access* <b>5 Operations Menu and Setup Menu full R/W access</b> *You can change the security level at any level
<input type="checkbox"/> <b>SEn</b> [SEn]	<b>Sensor Type</b> Set the analog sensor type to match the device wired to this input. Appears if: Always	<input type="checkbox"/> <b>TC</b> Thermocouple <input type="checkbox"/> <b>Volts</b> dc <input type="checkbox"/> <b>mA</b> Milliamps dc <input type="checkbox"/> <b>RTD</b> 100 Ω
<input type="checkbox"/> <b>Lin</b> [Lin]	<b>Linearization</b> Set the linearization to match the thermocouple type wired to this input. For example, select <b>H</b> for a type K thermocouple. Appears if: Sensor Type is set to Thermocouple.	<input type="checkbox"/> <b>B</b> B <input type="checkbox"/> <b>J</b> J <input type="checkbox"/> <b>T</b> T <input type="checkbox"/> <b>C</b> C <input type="checkbox"/> <b>K</b> K <input type="checkbox"/> <b>D</b> D <input type="checkbox"/> <b>N</b> N <input type="checkbox"/> <b>E</b> E <input type="checkbox"/> <b>R</b> R <input type="checkbox"/> <b>F</b> F <input type="checkbox"/> <b>S</b> S
<input type="checkbox"/> <b>dEC</b> [dEC]	<b>Decimal</b> Set the precision of the displayed value. Appears if: Always	<input type="checkbox"/> <b>Whole</b> <input type="checkbox"/> <b>Tenths</b> <input type="checkbox"/> <b>Hundredths</b>
<input type="checkbox"/> <b>C.F</b> [C.F]	<b>Display Units</b> Select which units will be displayed. Appears if: Always	<input type="checkbox"/> <b>F</b> °F <input type="checkbox"/> <b>C</b> °C
<input type="checkbox"/> <b>r.Lo</b> [r.Lo]	<b>Range Low</b> Set the low range of the set point. Appears if: Always	-1,999.000 to 9,999.000 <b>0.0</b>
<input type="checkbox"/> <b>r.Hi</b> [r.Hi]	<b>Range High</b> Set the high range of the set point. Appears if: Always	-1,999.000 to <b>9,999.000</b>
<input type="checkbox"/> <b>Fn1</b> [fn1]	<b>Function of Output 1</b> Select which function will drive this output. Appears if: If output 1 is ordered	<input type="checkbox"/> <b>OFF</b> Off <input type="checkbox"/> <b>Cool</b> Cool <input type="checkbox"/> <b>Heat</b> Heat <input type="checkbox"/> <b>Alarm</b> Alarm
<input type="checkbox"/> <b>o.ty</b> [o.ty]	<b>Output Type</b> Select whether the process output will operate in volts or milliamps. Appears if: A process output (PM_C_F_ AAAB_)	<input type="checkbox"/> <b>Volts</b> <input type="checkbox"/> <b>Milliamps</b>

To enter the Setup Menu push and hold the up and down arrow keys for approximately 3 seconds. Once there, push the green advance key to scroll through to the prompt of choice and then use the up and down arrow keys to change the range. At any point within the Setup menu to return to the default display push the Infinity  $\infty$  key.

### Setup Menu

- L o C** Lockout Menu
- S E n** Sensor Type
- L i n** Linearization
- d E C** Decimal
- [ . F ]** Display Units
- r L o** Range Low
- r h i** Range High
- F n 1** Function One
- o k y** Output Type
- F n 2** Function Two
- h A g** Heat Algorithm
- h S C** Heat Hysteresis
- [ C A g ]** Cool Algorithm
- A l y** Alarm Type
- A h y** Alarm Hysteresis
- A L g** Alarm Logic
- A L A** Alarm Latching
- A b L** Alarm Blocking
- A S i** Alarm Silencing
- A d S P** Alarm Display
- r P** Ramp Action
- r r E** Ramp Rate
- S L o 1** Scale Low
- S h i 1** Scale High
- o h i 1** Power Scale High Output 1
- o h i 2** Power Scale High Output 2
- P A r 1** Upper or Left Display
- P A r 2** Lower or Right Display
- A d S** Zone Address

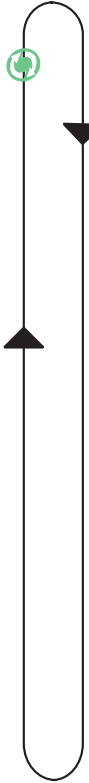

Setup Menu 16 <sup>th</sup> & 32 <sup>nd</sup> DIN PID Controller		
Display	Parameter Name Description	Range (Defaults are shown bold)
<b>[ F n 2 ]</b> [ fn2]	<b>Function of Output 2</b> Select which function will drive this output. Appears if: If output 2 is ordered	<input type="checkbox"/> <b>o F F</b> Off <input type="checkbox"/> <b>C o o L</b> Cool <input type="checkbox"/> <b>h e a t</b> Heat <input type="checkbox"/> <b>A l a r m</b> Alarm
<b>[ h A g ]</b> [ h.Ag]	<b>Heat Algorithm</b> Set the heat control method. Appears if: Output 1 or 2 set to heat	<input type="checkbox"/> <b>o F F</b> Off <input type="checkbox"/> <b>P i d</b> PID <input type="checkbox"/> <b>o n o f f</b> On-Off
<b>[ h S C ]</b> [ hSC]	<b>Hysteresis (Heat &amp; Cool)</b> Set the control switching hysteresis for on-off control. This determines how far into the "on" region the process value needs to move before the output turns on. Appears if: Heat or Cool Algorithm is set to On-Off.	0 to 9,999.000°F or units 0 to 5,555.000°C <b>Units, 3.0°F or 2.0°C</b>
<b>[ C A g ]</b> [ C.Ag]	<b>Cool Algorithm</b> Set the cool control method. Appears if: If Output 1 or 2 is set to cool	<input type="checkbox"/> <b>o F F</b> Off <input type="checkbox"/> <b>P i d</b> PID <input type="checkbox"/> <b>o n o f f</b> On-Off
<b>[ A l y ]</b> [ A.ly]	<b>Alarm Type</b> Select how the alarm will or will not track the set point. Appears if: Always	<input type="checkbox"/> <b>o F F</b> Off <input type="checkbox"/> <b>P r o c</b> Process Alarm <input type="checkbox"/> <b>d e v i a t i o n</b> Deviation Alarm
<b>[ A h y ]</b> [ A.hy]	<b>Alarm Hysteresis</b> Set the hysteresis for an alarm. This determines how far into the safe region the process value needs to move before the alarm can be cleared. Appears if: When alarm type is set to process or deviation alarm	0.001 to 9,999.000°F or units 0.001 to 5,555.000°C <b>Units, 1.0°F or 1.0°C</b>
<b>[ A L g ]</b> [ A.Lg]	<b>Alarm Logic</b> Select what the output condition will be during the alarm state. Appears if: Always	<input type="checkbox"/> <b>A l o s e</b> Close on Alarm <input type="checkbox"/> <b>A l o</b> Open on alarm
<b>[ A L A ]</b> [ A.LA]	<b>Alarm Latching</b> Turn alarm latching on or off. A latched alarm has to be turned off by the user. Appears if: When alarm type is set to process or deviation alarm	<input type="checkbox"/> <b>n o n - l a t c h i n g</b> Non-Latching <input type="checkbox"/> <b>l a t c h i n g</b> Latching
<b>[ A b L ]</b> [ A.bL]	<b>Alarm Blocking</b> Select when an alarm will be blocked. After startup and/or after the set point changes, the alarm will be blocked until the process value enters the normal range. Appears if: When alarm type is set to process or deviation alarm	<input type="checkbox"/> <b>o F F</b> Off <input type="checkbox"/> <b>S t a r t u p</b> Startup <input type="checkbox"/> <b>S e t P o i n t</b> Set Point <input type="checkbox"/> <b>B o t h</b> Both
<b>[ A S i ]</b> [ A.Si]	<b>Alarm Silencing</b> Turn alarm silencing on to allow the user to disable the output tied (configured) to this alarm Appears if: When alarm type is set to process or deviation alarm	<input type="checkbox"/> <b>o F F</b> Off <input type="checkbox"/> <b>o n</b> On

17 | 18  
19 | 20

To enter the Setup Menu push and hold the up and down arrow keys for approximately 3 seconds. Once there, push the green advance key to scroll through to the prompt of choice and then use the up and down arrow keys to change the range. At any point within the Setup menu to return to the default display push the Infinity  $\infty$  key.

### Setup Menu

- L o C** Lockout Menu
- S E n** Sensor Type
- L i n** Linearization
- d E C** Decimal
- [ . F ]** Display Units
- r L o** Range Low
- r h i** Range High
- F n 1** Function One
- o k y** Output Type
- F n 2** Function Two
- h A g** Heat Algorithm
- h S C** Heat Hysteresis
- [ C A g ]** Cool Algorithm
- A l y** Alarm Type
- A h y** Alarm Hysteresis
- A L g** Alarm Logic
- A L A** Alarm Latching
- A b L** Alarm Blocking
- A S i** Alarm Silencing
- A d S P** Alarm Display
- r P** Ramp Action
- r r E** Ramp Rate
- S L o 1** Scale Low
- S h i 1** Scale High
- o h i 1** Power Scale High Output 1
- o h i 2** Power Scale High Output 2
- P A r 1** Upper or Left Display
- P A r 2** Lower or Right Display
- A d S** Zone Address



Setup Menu 16 <sup>th</sup> & 32 <sup>nd</sup> DIN PID Controller		
Display	Parameter Name Description	Range (Defaults are shown bold)
<b>[ A d S P ]</b> [ A.dSP]	<b>Alarm Display</b> Display an alarm message when an alarm is active. Appears if: When alarm type is set to process or deviation alarm	<input type="checkbox"/> <b>o F F</b> Off <input type="checkbox"/> <b>o n</b> On
<b>[ r P ]</b> [ rP]	<b>Ramp Action</b> Select when the controller's set point will ramp to the defined end set point. Appears if: Always	<input type="checkbox"/> <b>o F F</b> Off <input type="checkbox"/> <b>S t a r t u p</b> Startup <input type="checkbox"/> <b>S e t P o i n t</b> Set Point Change <input type="checkbox"/> <b>B o t h</b> Both
<b>[ r r E ]</b> [ r.rE]	<b>Ramp Rate</b> Set the rate for the set point ramp. Set the time units for the rate with the Ramp Scale parameter. Appears if: Ramp Action is set to Startup, Set Point or Both.	<b>1.0°F</b> degrees or units per hour <b>1.0°C</b>
<b>[ S L o 1 ]</b> [ S.Lo1]	<b>Scale Low Output 1</b> Set minimum value of output 1 range. Appears if: Output 1 is a <i>Process</i> set to heat or cool	-100.0 to 100.0 <b>0.0</b>
<b>[ S h i 1 ]</b> [ S.hi1]	<b>Scale High Output 1</b> Set maximum value of output 1 range. Appears if: Output 1 is a <i>Process</i> set to heat or cool	-100.0 to 100.0 <b>10.0</b>
<b>[ o h i 1 ]</b> [ o.hi1]	<b>Power Scale High Output 1</b> Set maximum value of output 1 range. Appears if: Output 1 is <i>Switched</i> and set to heat or cool	0.0 to 100% <b>100.0</b>
<b>[ o h i 2 ]</b> [ o.hi2]	<b>Power Scale High Output 2</b> Set maximum value of output 2 range. Appears if: Output 2 is <i>Switched</i> and set to heat or cool	0.0 to 100% <b>100.0</b>
<b>[ P A r 1 ]</b> [ PAr1]	<b>Upper or Left Display</b> Select parameter to display. Appears if: Always	<input type="checkbox"/> <b>A c t i v e P r o c e s s V a l u e</b> Active Process Value <input type="checkbox"/> <b>n o n e</b> none
<b>[ P A r 2 ]</b> [ PAr2]	<b>Lower or Right Display</b> Select parameter to display. Appears if: Always	<input type="checkbox"/> <b>A c t i v e S e t P o i n t</b> Active Set Point <input type="checkbox"/> <b>A l a r m H i g h S e t P o i n t</b> Alarm High Set Point <input type="checkbox"/> <b>A l a r m L o w S e t P o i n t</b> Alarm Low Set Point <input type="checkbox"/> <b>n o n e</b> None
<b>[ A d S ]</b> [ Ad.S]	<b>Zone Address - Standard Bus Communication</b> Set zone address from 1-16. Appears if: Always	1-16 <b>1</b>

**Specifications**

**Line Voltage/Power**

- All voltage levels represent minimums and maximums
- 85 to 264V~(ac), 47 to 63Hz
- 20 to 28V~(ac), +10/-15 percent; 50/60Hz, ±5 percent
- 12 to 40V=(dc)
- 10VA maximum power consumption
- Data retention upon power failure via nonvolatile memory
- Compliant with SEMI F47-0200, Figure R1-1 voltage sag requirements @ 24V~(ac) or higher

**Environment**

- 18 to 65°C (0 to 149°F) operating temperature
- 40 to 85°C (-40 to 185°F) storage temperature
- 0 to 90 percent RH, non-condensing

**Accuracy**

- Calibration accuracy and sensor conformity: ±0.1 percent
- span, ±1°C @ the calibrated ambient temperature and rated line voltage
  - Type S, 0.2 percent
  - Type T, below -50°C: 0.2 percent
- Calibration ambient temperature @ 25°C ±3°C (77°F ±5°F)
- Accuracy span: 540°C (1000°F) minimum
- Temperature stability: ±0.1°C/°C (±0.1°F/°F) rise in ambient maximum

**Agency Approvals**

- UL®/EN 61010 Listed
- ANSI/ISA 12.12.01-2007 Class 1 Division 2 Groups A, B, C, D, Temperature Code T4A
- UL@ 50, NEMA 4X, EN 60529 IP66 (indoor use only)
- CSA C22.2 No. 24 File 158031
- RoHS, W.E.E.E.
- SEMI F47-0200

**Controller**

- User selectable heat/cool, on-off, P, PI, PD, PID or alarm action
- Auto-tune control algorithm
- Control sampling rates: input = 10Hz, outputs = 10Hz
- Input and output capacity per controller type ordering information

**Serial Communications**

- Isolated communications
- Standard Bus Configuration Protocol

**Wiring Termination—Touch-Safe Terminals**

- Input, power and controller output terminals are touch safe removable 12 to 22 AWG

- Use 75°C, Cu conductor only

**Universal Input**

- Thermocouple, grounded or ungrounded sensors
- >20MΩ input impedance
- Maximum of 2KΩ source resistance
- RTD 2- or 3-wire, platinum, 100Ω @ 0°C calibration to DIN curve (0.00385 Ω/Ω°C)
- Process, 4-20mA @ 100Ω, or 0-10V=(dc) @ 20kΩ input impedance; scalable

**Functional Operating Range**

- Type B: -50 to 1816°C (-58 to 3301°F)
- Type C: 0 to 2315°C (32 to 4199°F)
- Type D: 0 to 2315°C (-328 to 4199°F)
- Type E: -270 to 1000°C (-454 to 1832°F)
- Type F: 0 to 1343°C (32 to 2449°F)
- Type J: -210 to 1200°C (-346 to 2192°F)
- Type K: -270 to 1371°C (-454 to 2500°F)
- Type N: -200 to 1300°C (-328 to 2372°F)
- Type R: -50 to 1767°C (-58 to 3213°F)
- Type S: -50 to 1767°C (-58 to 3213°F)
- Type T: -270 to 400°C (-454 to 752°F)
- RTD (DIN): -200 to 800°C (-328 to 1472°F)
- Process: -1999 to 9999 units

**Output Hardware**

- Switched dc, 22 to 32V=(dc) with a maximum of 40 mA supply current available.
- Open collector, maximum sink current 100 mA, @ 30V=(dc)
- Solid state relay (SSR), Form A, 0.5A @ 24V~(ac) minimum, 264V~(ac) maximum, opto-isolated, without contact suppression
- Electromechanical relay, Form C, 5A, 24 to 240V~(ac) or 30V=(dc) maximum, resistive load, 100,000 cycles at rated load
- Electromechanical relay, Form A, 5A, 24 to 240V~(ac) or 30V=(dc) maximum, resistive load, 100,000 cycles at rated load
- NO-ARC relay, Form A, 15A, 24 to 240V~(ac), no V=(dc), resistive load, 2 million cycles at rated load
- Universal process:
  - 0 to 10V=(dc) into a minimum 1,000Ω load
  - 4 to 20mA into maximum 800Ω load

**Operator Interface**

- Dual 4 digit, 7 segment LED displays
- Typical display update rate 1Hz
- Advance, infinity, up and down keys plus an EZ-KEY key (not available in 1/32 DIN)
- EZ-KEY automatically programmed as an Auto/Manual transfer mode function.

**Ordering Part Number**

(Part number digits 1 through 14) PMXCXXX-AAAABXX

All Models include: \*Universal Sensor Input, Standard Bus Configuration Communications \*Dual line Red over Green 7 Segment displays

**Package Size (Digit #3)**

- 3 = 1/32 DIN
- 6 = 1/16 DIN
- 8 = 1/8 DIN vertical (future option)
- 9 = 1/8 DIN horizontal (future option)
- 4 = 1/4 DIN (future option)

**Primary Function (Digit #4)**

C = PID Controller w/ Universal Input

**Power Supply (Digit #5)**

- 1 = 100-240 VAC
- 3 = 12-28VAC/DC

**Output 1 and 2 Hardware Options (Digits #6 and #7)**

- |                                    |                             |
|------------------------------------|-----------------------------|
| Output 1                           | Output 2                    |
| CA = Switched dc/open collector    | None                        |
| CH = Switched dc/open collector    | NO-ARC 15 Amp power control |
| CC = Switched dc/open collector    | Switched DC                 |
| CJ = Switched dc/open collector    | Mechanical relay 5A, Form A |
| CK = Switched dc/open collector    | SSR Form A, 0.5 Amp         |
| EA = Mechanical Relay 5 Amp form C | None                        |
| EH = Mechanical Relay 5 Amp form C | NO-ARC 15 Amp power control |
| EC = Mechanical Relay 5 Amp form C | Switched DC                 |
| EJ = Mechanical Relay 5 Amp form C | Mechanical relay 5A, Form A |
| ER = Mechanical Relay 5 Amp form C | SSR Form A, 0.5 Amp         |
| FA = Universal Process             | None                        |
| FC = Universal Process             | Switched DC                 |
| FJ = Universal Process             | Mechanical relay 5A, Form A |
| FK = Universal Process             | SSR Form A, 0.5 Amp         |
| AK = None                          | SSR Form A, 0.5 Amp         |
| KK = SSR Form A, 0.5 Amp           | SSR Form A, 0.5 Amp         |

**Future Options (Digits #8 thru #11)**

AAAA = None

**Menu Type (Digits #12)**

B = PM Express with English manual (Limit or PID)

**Additional Options (Digits #13 and #14)**

AA = Standard EZ-ZONE face plate  
 12 = Class 1, Div 2 (not available with Limit Controller or mechanical relay outputs)

Multilingual User Manuals (PID only) and associated Watlow part numbers:

- English 0600-0065-0000
- Chinese 0600-0065-0001
- Japanese 0600-0065-0002
- Korean 0600-0065-0003
- German 0600-0065-0004
- French 0600-0065-0005
- Italian 0600-0065-0006
- Spanish 0600-0065-0007

21 22  
23 24

**Declaration of Conformity**



**Series EZ-ZONE<sup>®</sup> PM**

**WATLOW**  
 1241 Bundy Blvd.  
 Winona, MN 55987 USA

an ISO 9001 approved facility since 1996.

Declares that the following product:

Designation: **Series EZ-ZONE<sup>®</sup> PM (Panel Mount)**  
 Model Numbers: PM (3, 6, 8, 9 or 4)(Any Letter or number) – (1, 2, 3 or 4)(A, C, E, F or K) (A, C, H, J or K)(Any letter or number) – (Any letter or number)(A, C, E, F or K)(A, C, H, J or K) (Any three letters or numbers)  
 Classification: Temperature control, Installation Category II, Pollution degree 2, IP66  
 Rated Voltage and Frequency: 100 to 240 V~ (ac 50/60 Hz) or 15 to 36 Vldc/ 24 V~ac 50/60 Hz  
 Rated Power Consumption: 10 VA maximum PM3, PM6 Models.  
 14 VA maximum PM8, PM9, PM4 Models

Meets the essential requirements of the following European Union Directives by using the relevant standards show below to indicate compliance.

<b>EN 61326-1</b>	<b>2006</b>	<b>2004/108/EC Electromagnetic Compatibility Directive</b> <b>Electrical equipment for measurement, control and laboratory use – EMC requirements (Industrial Immunity, Class B Emissions).</b>
EN 61000-4-2	1996 +A1,A2	Electrostatic Discharge Immunity
EN 61000-4-3	2006	Radiated Field Immunity 10V/M 80–1000 MHz, 3 V/M 1.4–2.7 GHz
EN 61000-4-4	2004	Electrical Fast-Transient / Burst Immunity
EN 61000-4-5	2006	Surge Immunity
EN 61000-4-6	1996 +A1,A2,A3	Conducted Immunity
EN 61000-4-11	2004	Voltage Dips, Short Interruptions and Voltage Variations Immunity
EN 61000-3-2	2006	Harmonic Current Emissions
EN 61000-3-3*	2005	Voltage Fluctuations and Flicker
SEMI F47	2000	Specification for Semiconductor Sag Immunity Figure R1-1

\*For mechanical relay loads, cycle time may need to be extended up to 160 seconds to meet flicker requirements depending on load switched and source impedance.

<b>EN 61010-1</b>	<b>2001</b>	<b>2006/95/EC Low-Voltage Directive</b> <b>Safety Requirements of electrical equipment for measurement, control and laboratory use. Part 1: General requirements</b>
-------------------	-------------	---

**Compliant with 2002/95/EC RoHS Directive**

Per 2002/96/EC W.E.E.E Directive Please Recycle Properly.

Raymond D. Feller III Name of Authorized Representative	Winona, Minnesota, USA Place of Issue
General Manager Title of Authorized Representative	June 2009 Date of Issue

Signature of Authorized Representative

**How to Reach Us**

**Corporate Headquarters**

Watlow Electric Manufacturing Company  
 12001 Lackland Road  
 St. Louis, MO 63146  
 Sales: 1-800-WATLOW2  
 Manufacturing Support: 1-800-4WATLOW  
 Email: info@watlow.com  
 Website: www.watlow.com  
 From outside the USA and Canada:  
 Tel: +1 (314) 878-4600  
 Fax: +1 (314) 878-6814

**Latin America**

Watlow de México S.A. de C.V.  
 Av. Funciones No. 5  
 Col. Parques Industriales  
 Querétaro, Qro. CP-76130  
 Mexico  
 Tel: +52 442 217-6235  
 Fax: +52 442 217-6403

**Europe**

Watlow France  
 Tour d'Asnières  
 4 Avenue Laurent Cely  
 92600 Asnières sur Seine  
 France  
 Tel: + 33 (0) 1 41 32 79 70  
 Télécopie: + 33(0) 1 47 33 36 57  
 Email: info@watlow.fr  
 Website: www.watlow.fr

Watlow GmbH  
 Postfach 11 65, Lauchwasenstr. 1  
 D-76709 Kronau  
 Germany  
 Tel: +49 (0) 7253 9400-0  
 Fax: +49 (0) 7253 9400-900  
 Email: info@watlow.de  
 Website: www.watlow.de

Watlow Italy S.r.l.  
 Viale Italia 52/54  
 20094 Corsico MI  
 Italy  
 Tel: +39 024588841  
 Fax: +39 0245869954  
 Email: italyinfo@watlow.com  
 Website: www.watlow.it

Watlow Ibérica, S.L.U.  
 C/Marte 12, Posterior, Local 9  
 E-28850 Torrejón de Ardoz  
 Madrid - Spain  
 T. +34 91 675 12 92  
 F. +34 91 648 73 80  
 Email: info@watlow.es  
 Website: www.watlow.es

Watlow UK Ltd.  
 Linby Industrial Estate  
 Linby, Nottingham, NG15 8AA  
 United Kingdom  
 Telephone: (0) 115 964 0777  
 Fax: (0) 115 964 0071  
 Email: info@watlow.co.uk  
 Website: www.watlow.co.uk  
 From outside The United Kingdom:  
 Tel: +44 115 964 0777  
 Fax: +44 115 964 0071

**Asia and Pacific**

Watlow Singapore Pte Ltd.  
 16 Ayer Rajah Crescent,  
 #06-03/04  
 Singapore 139965  
 Tel: +65 6773 9488 Fax: +65 6778 0323  
 Email: info@watlow.com.sg Website: www.watlow.com.sg

Watlow Korea Co., Ltd.  
 #1406, E&C Dream Tower, 46, Yangpyeongdong-3ga  
 Yeongdeungpo-gu, Seoul 150-103  
 Republic of Korea  
 Tel: +82 (2) 2628-5770 Fax: +82 (2) 2628-5771  
 Website: www.watlow.co.kr

Watlow Australia Pty., Ltd.  
 4/57 Sharps Road  
 Tullamarine, VIC 3043  
 Australia  
 Tel: +61 3 9335 6449  
 Fax: +61 3 9330 3566  
 Website: www.watlow.com

Watlow Malaysia Sdn Bhd  
 No. 14-3 Jalan 2/114  
 Kuchai Business Centre  
 Jalan Kuchai Lama  
 58200 Kuala Lumpur  
 Malaysia  
 Tel: +60 3 7980 7741 Fax: +60 3 7980 7739

Watlow Electric Manufacturing (Shanghai) Company  
 1118 Fangyuan Road, Anting Industrial Park, Jiading, Shanghai,  
 PRC 201203  
 People's Republic of China  
 Tel: +86 21 39509510  
 Fax: +86 21 5080-0906  
 Email: info@watlow.cn  
 Website: www.watlow.cn

瓦特龍電機股份有限公司  
 80143 高雄市新金區七賢二路189號10樓之一  
 電話: 07-2885168 傳真: 07-2885568  
 Watlow Electric Taiwan Corporation  
 10F-1 No.189 Chi-Shen 2nd Road Kaohsiung 80143  
 Taiwan  
 Tel: +886-7-2885168 Fax: +886-7-2885568

ワトロー電気株式会社  
 〒101-0047 東京都千代田区神田1-14-4  
 四国ビル別館9階  
 Tel: 03-3518-6630 Fax: 03-3518-6632  
 Email: info@watlow.com Website: www.watlow.co.jp  
 Watlow Japan Ltd.  
 1-14-4 Uchikanda, Chiyoda-Ku  
 Tokyo 101-0047  
 Japan  
 Tel: +81-3-3518-6630 Fax: +81-3-3518-6632  
 Email: info@watlow.com Website: www.watlow.co.jp

**Your Authorized Watlow Distributor**

